

Norwegian University
of Life Sciences

Master's Thesis 2016 60 ECTS

Department of Ecology and Natural Resource Management (INA)

Effects of nutrient enrichment on stream benthos override those of fine sediment addition: a flume experiment

Semona Issa
General Ecology

Abstract

1. Agricultural runoff greatly contributes to stream eutrophication and sedimentation, which in turn can severely impact the benthic algal and invertebrate communities. Our aim was to determine the combined and individual effects, of both nutrient and sediment stressors, on benthic algae and invertebrates, at the taxon and community level, as well as leaf litter degradation, a measure of ecosystem functioning.
2. Eight experimental stream channels (10×0.5×0.3 m, LWH), supplied with water from a nearby nutrient- and sediment-rich stream, were subjected for 43 days, to combined levels (low versus high) of phosphorus and clay in a controlled experiment. Invertebrates were sampled from leaf bags filled with alder leaves, to determine their composition and abundance. Benthic algae were allowed to grow on unglazed tiles, and algal composition was analyzed weekly for 6 weeks. Rates of leaf litter degradation were also determined from leaf bags.
3. Measured response variables included the biomass and density of invertebrate and algal taxa; diversity, evenness and taxon richness of both invertebrate and algal communities; percentage abundance of algal growth forms; invertebrate consumption and microbial decomposition of alder leaves; and various physicochemical properties of water. Nutrient enrichment was the most pervasive stressor, directly impacting 37% of all biological response variables, while fine sediment addition impacted only 3%. Nutrient enrichment increased algal biomass and rates of leaf litter degradation and decreased invertebrate densities, while increasing invertebrate richness, diversity and evenness. Sediment addition on the other hand, exerted a very limited effect at the taxon level of both algal and invertebrate communities.
4. Interactions between stressors occurred rarely and were antagonistic. The river biota showed mixed responses to combined levels of clay and phosphorus. The negative effect of clay on the invertebrate community, was weakened under phosphorus enrichment. Moreover, the positive effect of added phosphorus on rates of leaf litter degradation, was masked by high levels of added sediment.
5. Our main findings show that phosphorus exerted a strong separate effect on the stream biota when added in combination with fine sediment, which had barely any effect. Thus, P enrichment from agricultural runoff, can severely impact streams that are already rich in P and fine sediments. It is therefore critical to control agricultural runoff, in order to mitigate its impacts on the water quality and ecological integrity of rivers and streams. Also, interactions between nutrients, sediments and multiple other anthropogenic stressors, need to be addressed in future research, to fully comprehend consequences of agricultural practices in lotic ecosystems.

Preface

This thesis is submitted in partial fulfilment of the requirements for a Master's degree in General Ecology at the Norwegian University of Life Sciences, Department of Ecology and Natural Resource Management (INA). The master's project was funded by the Norwegian Institute for Water Research (NIVA) and took place at the NIVA field station in Solbergstrand, south of Drøbak.

I have received academic and practical support throughout the entire thesis process. Therefore, I would first like to thank my head supervisor, Susanne Claudia Schneider, and co-supervisor, Nikolai Friberg, for their time, valuable input and guidance.

I also thank Vibeke Hoff and Jens Thaulow, who have made fieldwork a lot easier and more fun. I am in addition very grateful to all the working staff at the NIVA field station in Solbergstrand, for all their technical support.

I further offer my gratitude to Professor Rolf Sørensen, for all his useful comments, and a special thanks to Post Doc. Guro Dørum and Professor Solve Sæbø, for helping me solve technical issues encountered in R and providing me with statistical advice.

Finally, I deeply thank Martha and my family, for being supportive and an everlasting source of inspiration.

Norwegian University of Life Sciences

August 2016

Semona Issa

Table of Contents

| | | |
|---|---|-----------|
| 1 | Introduction | 1 |
| 2 | Materials and methods | 4 |
| 2.1 | Experimental procedure | 4 |
| 2.2 | Experimental setup | 5 |
| 2.3 | Applied treatments | 7 |
| 2.4 | Field work | 8 |
| 2.4.1 | Tile and leaf bag preparations | 8 |
| 2.4.2 | Sampling of tiles and leaf bags | 9 |
| 2.4.3 | Physicochemical properties of water | 10 |
| 2.5 | Laboratory procedures | 10 |
| 2.5.1 | Algal community | 10 |
| 2.5.2 | Invertebrate community | 12 |
| 2.6 | Statistical analysis | 12 |
| 3 | Results | 14 |
| 3.1 | Physicochemical properties of water | 14 |
| 3.2 | Algae | 18 |
| 3.3 | Invertebrates | 23 |
| 3.4 | Leaf litter degradation | 27 |
| 4 | Discussion | 27 |
| 4.1 | Physicochemical properties of water | 27 |
| 4.2 | Individuals effects of sediment addition | 27 |
| 4.3 | Individuals effects of phosphorus addition | 28 |
| 4.4 | Stressors compared: sediment versus phosphorus | 29 |
| 4.5 | Interactions between sediment and phosphorus addition | 30 |
| 4.6 | Management implications | 31 |
| 5 | Literature cited | 35 |
| | | |
| Appendix 1: Detailed experimental setup | | 41 |
| Appendix 1.1: Supply tank | | 41 |
| Appendix 1.2: Drums | | 41 |
| Appendix 1.3: Supply holes and pumps | | 42 |
| Appendix 1.4: Water circulation | | 42 |
| Appendix 2: Schematic description of weirs | | 43 |

| | |
|---|-----------|
| Appendix 3: Description of invertebrate sampling station | 44 |
| Appendix 4: Clay homogenization | 46 |
| Appendix 5: Calculated treatment concentrations | 47 |
| Appendix 6: Photos of tiles and mesh bags | 48 |
| Appendix 6.1: Tiles | 48 |
| Appendix 6.2: Mesh bags | 48 |
| Appendix 7: Microscope image of F. P. Cyanobacterium | 49 |
| Appendix 8: NMDS stress plots | 50 |
| Appendix 9: Responses to treatments | 51 |
| Appendix 9.1: Responses of algae and ciliates | 51 |
| Appendix 9.2: Responses of invertebrates | 53 |
| Appendix 9.3: Response of invertebrate consumption of leaf litter | 54 |

1 Introduction

The growing rate of nutrient discharge into streams and rivers has greatly impacted the ecological status of many lotic ecosystems worldwide (Droic & Koncan, 2002; Jarvie, Neal, & Withers, 2006; Mainstone & Parr, 2002). Nutrient enrichment promotes the excessive growth of riverine primary producers, mainly algae and aquatic macrophytes. Aerobic bacteria that decompose dying algal blooms, will then deplete the oxygen in the water, leading to anoxic conditions and possible death of remaining living organisms in the river. This ecologically degrading process is known as eutrophication (Shaw, Moore, & Garnett, 2003).

Phosphorus (P) often is the key element that causes eutrophication, since it is usually the limiting nutrient for plant growth in freshwater ecosystems (Grobbelaar & House, 1995; Mainstone & Parr, 2002). P enters the river through point sources, mainly sewage and industrial discharge, and diffuse sources, mainly agricultural runoff (Droic & Koncan, 2002). Agricultural soil is eroded and deposited in rivers, adding to their nutrient loads through sediment-associated P. As such, agriculture contributes significantly to the total annual phosphorus load in lotic ecosystems (Jarvie et al., 2006). Eroded agricultural sediments, apart from the fact that they carry nutrients, have an additional impact on the ecology of rivers.

In fact, high sediment loading in the river increases turbidity level and reduces access of aquatic primary producers to light, necessary for photosynthesis (Yamada & Nakamura, 2002; Young, Matthaei, & Townsend, 2008). Mobilized sediment is also responsible for the direct scouring of algae, which may alter algal assemblages (Vaselli, Bertocci, Maggi, & Benedetti-Cecchi, 2008). Subsequently, changes in species abundance and distribution of primary producers, may indirectly impact stream organisms, including fish and invertebrate species (Matthaei, Weller, Kelly, & Townsend, 2006).

Overall, it is urgently needed to control diffuse sources of pollution, particularly from intensive agriculture, on a global scale. This is a particular challenge to water management, since diffuse sources occur over large spatial scales and are controlled by weather conditions, responsible for transporting and transforming pollutants through air, soil and water (Droic & Koncan, 2002). Furthermore, with the ever growing human population and need for food, agricultural activity is bound to increase. As such, river restoration techniques will need to simultaneously target both eutrophication and sedimentation from agricultural sources (Wagenhoff, Townsend, & Matthaei, 2012).

Many studies to date have focused on the separate effects of either added P (Bowes et al., 2012; Serra, Guasch, Admiraal, Geest, & Beusekom, 2010; Slavik et al., 2004), or fine sediments (Matthaei et al., 2006; Prosser et al., 2001; Yamada & Nakamura, 2002), in river ecosystems. These studies offer too simplistic results, since different stressors in the ecosystem interact with each other, in an either additive, antagonistic, or synergistic manner (Piggott, Salis, Lear, Townsend, & Matthaei, 2015). Nevertheless, studies that have looked at interactions between stressors and their combined effects have recently increased (Matthaei, Piggott, & Townsend, 2010). Out of these, some have relied on field surveys (Lange, Townsend, & Matthaei, 2014; Yuan & Norton, 2004), while others on field experiments (Townsend, Uhlmann, & Matthaei, 2008).

Both field surveys and field experiments give more realistic results than laboratory experiments. However, field surveys do not allow the control of external factors, while field experiments offer some control, but demand greater effort than laboratory experiments (Townsend et al., 2008). An alternative research technique used is that of experimental stream channels, also called mesocosms or flumes (Magierowski et al., 2015; Wagenhoff et al., 2012). Mesocosms are a reasonable trade-off between laboratory experiments and field studies, as they provide fairly realistic environmental conditions, and the possibility to manipulate and control multiple variables, with greater ease of implementation. As such, mesocosm experiments have been widely useful tools in ecotoxicology and aquatic ecology (Perceval et al., 2009).

In this study, experimental stream channels at NIVAs field station, in Solbergstrand south of Drøbak, were used, supplied with water from a nearby stream. Agriculture is the most practiced form of land use and benefits from the clay-rich soil in the area (Berge, Nordal, & Hestmark, 1998; Snekerbakken, Ragnhildstveit, & Nordahl-Olsen, 2002). Clay is a very fine-grained sedimentary rock, less than 4 μm in grain size (Merriman, Highley, & Cameron, 2003), which can bind to nutrients, increasing the soil's fertility (Tucker, 1999). Phosphorus-based fertilizers are moreover used intensively to manage the agricultural crops (Bakken & Gillebo, 2011). Both clay and P end up in the river following erosion.

The aim of this study was to disentangle the interacting effects of phosphorus and clay augmentation on benthic algal and invertebrate assemblages, as well as leaf litter degradation. Nutrients and sediments have been shown to affect benthic algae (Piggott et al., 2015) and invertebrates (Wagenhoff, Townsend, Philips, & Matthaei, 2011), as well as ecosystem processes (Young et al., 2008), through complex interactions in rivers and streams. Benthic

algae and invertebrates are widely used as bioindicators of water quality and ecological integrity in rivers and streams (Metcalf, 1989). Benthic algae are in fact, the dominant primary producers in lotic ecosystems (Allan & Castillo, 2007), vulnerable to changes in nutrient availability, as well as disturbance pressure (Passy, 2007). Changes in their communities can be used to measure different disturbances, such as eutrophication, organic pollution, as well as habitat destruction (Struijs, Zwart, Posthuma, Leuven, & Huijbregts, 2011), and can lead to bottom-up effects on invertebrate communities through changes in resource availability (Wagenhoff, Lange, Townsend, & Matthaei, 2013). Invertebrates on the other hand, are the primary consumers in rivers and streams, and exert a top-down control of benthic algae and other primary producers through grazing. They are common, abundant, and diverse organisms that react differently to different types of stressors because of their various sensitivity to pollution. Their relative immobility and long life span furthermore make them representative of the local environmental conditions (Metcalf, 1989; Yazdian, Jaafarzadeh, & Zahraie, 2014). Thus, understanding the effects of multiple stressors on benthic algae and invertebrates, is an important step to understanding how these stressors affect the ecosystem as a whole.

In addition to bioindicators, ecosystem processes, such as leaf litter degradation, can be used as functional indicators of the ecosystem's integrity (Young et al., 2008). Leaf litter degradation is an essential ecosystem process, whereby the breakdown of riparian vegetation, by microbes and invertebrates, provides an important energy source to freshwater ecosystems (Webster & Benfield, 1986). Leaf litter degradation responds to different natural and anthropogenic stressors, and its disruption can negatively affect higher trophic levels through bottom-up effects (Wallace, Eggert, Meyer, & Webster, 1997). It is therefore also important to measure rates of leaf breakdown, when assessing river ecosystem health.

Our main objective, specifically, was to study the separate and interacting effects, of clay and phosphorus, on benthic algae and invertebrates, in addition to leaf litter degradation, when both were added in combination, as is normally the case from agricultural soil erosion. Clay has in fact been a part of the geology of the study area since the last Ice Age (Berge et al., 1998). It is a natural component of the riverbed and contains natural phosphorus. Therefore, it is important to find out whether clay-rich rivers and streams, which may contain phosphorus in the clay, can be naturally eutrophic; and whether they have a different benthic fauna and flora than clay-rich rivers and streams that receive additional phosphorus, as is the case from agricultural runoff.

Our hypotheses were:

1. Clay augmentation should decrease algal growth indirectly, via turbidity and directly, via scouring. As a consequence of reduction in food availability, invertebrate growth and leaf litter degradation, should in turn decrease.
2. Phosphorus addition would alleviate nutrient limitations, thereby acting as a subsidy to algae, resulting in an increase in their growth rate. Increased resource availability, would in turn have a positive effect on the invertebrate community and rates of leaf litter degradation.
3. Added clay and P are expected to counteract each other's effect on the biota. Therefore, when combined, their interaction should have an antagonistic effect on the invertebrate and algal communities, as well as rates of leaf litter degradation.

2 Materials and methods

2.1 Experimental procedure

Flume construction began on 1 June 2015. On 30 June, the bottom of the experimental channels was filled with mixed gravel, to provide a more natural turbulence that is evenly distributed by rock placements. Flume construction ended first of July. A total of 8 flumes were fully equipped to be used for the experiment (Fig. 1, 2a). Flumes were thereafter filled with water and spiked with invertebrates for the first time on 4 July (start of algae colonization). Flume 5 however, experienced severe leakage along with complete loss of biota and was fixed and refilled on 14 August. The 8 flumes were spiked with invertebrates for the second time four days later on 18 August. On 2 September (early Autumn), the flumes received tiles as well as mesh bags filled with alder leaves. The tiles were used as substrate for algae, while leaf bags were used to measure rates of leaf litter degradation. Later that day, the flumes were spiked with phosphorus and clay for the first time (day 0, start of the experiment). The experiment lasted for one month and a half, ending on 14 October 2015 (mid Autumn) (Fig. 1).

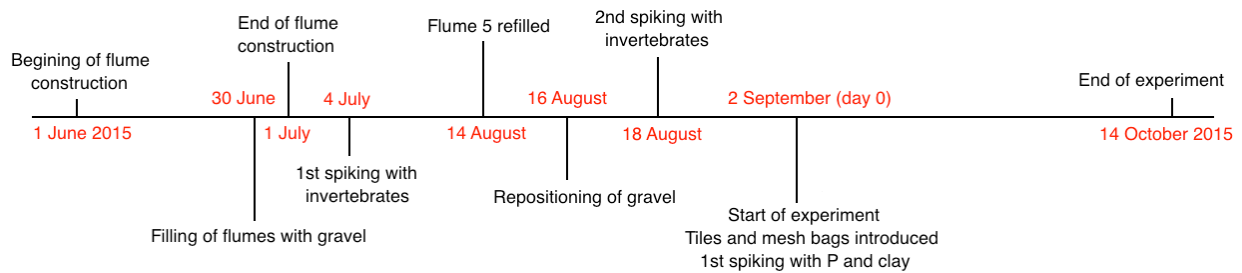

Fig. 1 Experimental procedure detailed in a chronological order.

2.2 Experimental setup

The experiment was conducted in 8 longitudinal steel flumes (10×0.5×0.3 m, LWH) set up at the NIVA field station at Solbergstrand, Drøbak, Norway. A large tank at the station supplied the flumes with freshwater from the nearby Solberg River (Fig. 2a, b, appendix 1.1), located at the boundary between Frogn and Vestby municipalities (Bakken & Gillebo, 2011). The bedrock is composed of gneiss rock covered by marine and fjord deposits (silt and clay) (Snekkerbakken et al., 2002). Land use is mainly intensive agriculture, contributing to more than a quarter of the annual supply of phosphorus and nitrogen, to freshwater ecosystems in the area (Bakken & Gillebo, 2011). Water quality in the Solberg River is currently classified within the range IV–V (very poor to poor) (Bakken & Gillebo, 2011), based on an analysis of bioindicators and a series of physicochemical parameters, conducted by PURA (2011).

A drum containing an automatic pump (Unilift AP35B, AP50B; GRUNDFOS) was carefully placed at the outlet of each flume (Fig. 2b, appendix 1.2). Water was continuously pumped to the flume inlet through a PVC pipe (Fig. 2b, appendix 1.4). Inflow and outflow weirs ensured equal flow and water depth across flumes (appendix 2). It was not possible to pump the same water across flumes for the whole period of the experiment, due to small leakages. To compensate for these leakages, supply holes (2 mm wide) were drilled through a common PVC pipe, providing the flumes with an additional source of water (Fig. 2b, appendix 1.3). These supply holes were cleaned regularly to prevent clogging and were kept on 5 days a week throughout the first and second sampling weeks, as a trial period. From that time until the end of the experiment, they were turned on for only 3 days a week, to maintain to the largest extent, the added stressors' concentrations.

On 16 August, the gravel was moved to form 6 riffle-pool sequences across all flumes in order to increase current velocity (Fig. 1, 2b). Each riffle-pool sequence was separated from the next by one meter. Average water depth was measured on a transect similar across all flumes with a ruler. At the level of “riffles”, average water depth was 10.2 ± 0.3 cm (standard

(a)

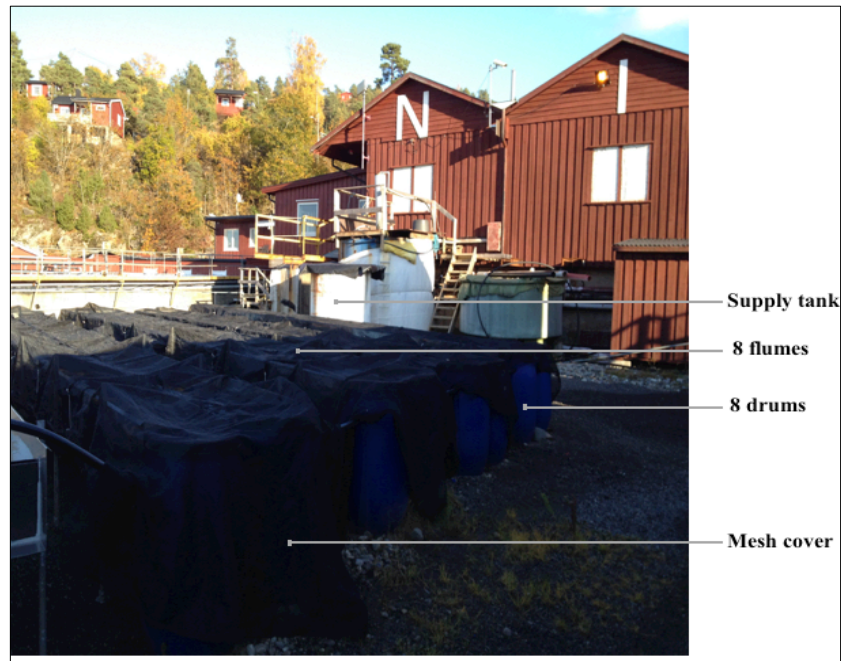

(b)

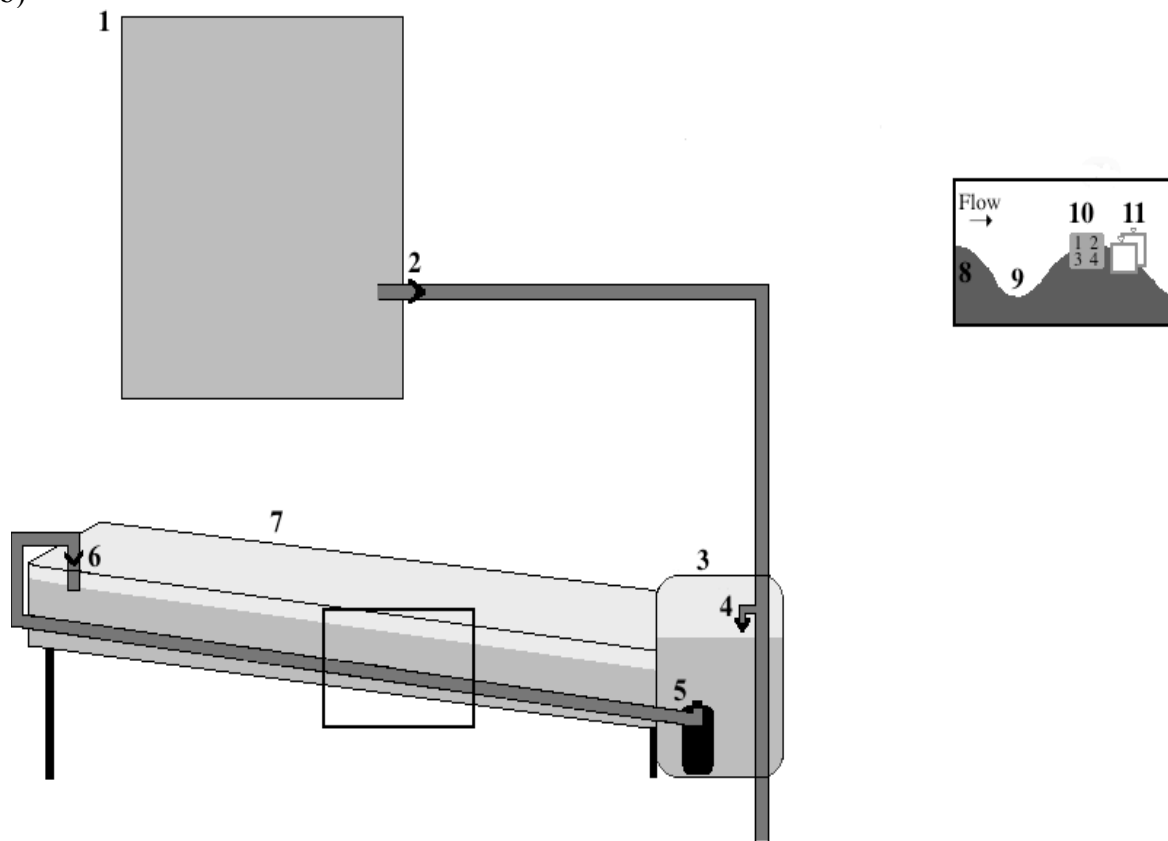

Fig. 2 (a) Photo of the experimental setup. (b) Schematic of the experimental setup using flume 1 as an example: (1) Source tank supplied with stream water from the Solberg River, (2) PVC pipe common to all flumes, (3) drum at the flume outlet, (4) supply hole in the PVC pipe, (5) automatic pump inside the drum, (6) PVC pipe connecting the pump to the flume inlet, (7) flume, (8) “riffle” and (9) “pool” structures formed with gravel, (10) tile (1, 2, 3 and 4 indicate the sequential Benthos measurements), (11) set of leaf bags.

error; n= 48) and 16.7 ± 0.3 cm (standard error; n= 48) at the level of “pools”. Throughout the entire experimental period, except during sampling events, each flume was completely covered by a black mesh (2×2 mm), to provide some shading and reduce effects of temperature, as well as prevent flying insects and seagulls from entering the flumes (Fig. 2a).

2.3 Applied treatments

Before spiking with P and clay, flumes needed to be spiked with invertebrates for the 2nd time. Invertebrate loads were collected moving upstream from distinct regions in riffle areas of the Solbergstrand stream, using a Surber sampler (30×30 cm) and were assigned randomly to flumes (appendix 3). All flumes received one standard invertebrate load, while flume 5 received two loads.

Four different treatments, with combined levels of phosphorus ($\text{HNa}_2\text{O}_4\text{P}\cdot 12\text{H}_2\text{O}$) and clay, were randomly assigned to flumes, with 2 replicates per treatment (Fig. 3). P and clay were first added on 2 September (day 0), then at constant concentrations on days 7, 13, 19, 25 and 31. Supply holes were turned off during spiking and kept off for 24 hours. The low P treatment was close to natural stream levels (TP means 33.8 ± 4.5 $\mu\text{g P/L}$ and 35.3 ± 8.5 $\mu\text{g P/L}$, see Table 2). For the high level treatment, enough P was added in an attempt to obtain a significantly larger TP concentration of 150 $\mu\text{g P/L}$. This value is close to maximum TP means previously measured in nearby streams (Eriksen, Lindholm, Røst, Solheim, & Friberg, 2015). Homogenized blue clay was also added to achieve the desired clay concentrations of 5 mg/L for low level treatment and 50 mg/L for high level treatment (appendix 4). These values were selected based on minimum and maximum mean concentrations of suspended solids, from field measurements of streams impacted by agriculture, in the lowlands of Eastern Norway (Eriksen et al., 2015).

In order to determine the amount of P and clay to add, the capacity of each flume and its respective drum was first estimated. First, flume capacity was deducted from the same formula used to estimate pool capacity: flume capacity= average water depth in flume× flume length× flume width, with average water depth recorded on a transect similar across all flumes, before gravel repositioning. Second, drum capacity was estimated by measuring the length of the drum area that is filled with water (X) and deducing the capacity of that area using total drum capacity and length (220 L and 93 cm respectively): drum capacity= (X× total capacity)/ total length. Both flume and drum capacities were then added to get the total capacity for each flume/drum set. The amount of clay to be added was calculated by

multiplying the target concentration (5 or 50 mg/L) by total capacity for each flume/drum set. As for the amount of P to be added, the mass of pure P contained in each gram of $\text{HNa}_2\text{O}_4\text{P} \cdot 12\text{H}_2\text{O}$ was first calculated as follows:

Molecular weight of P= 31 g/mol, while total molecular weight of $\text{HNa}_2\text{O}_4\text{P} \cdot 12\text{H}_2\text{O}$ = 358.14 g/mol. So for any X gram of $\text{HNa}_2\text{O}_4\text{P} \cdot 12\text{H}_2\text{O}$ the molecular weight is 358.14 g/mol. The mass of P within that X gram then needs to be determined.

If we assume X gram to be equal to 1 gram: $1 \text{ g HNa}_2\text{O}_4\text{P} \cdot 12\text{H}_2\text{O} \rightarrow 358.14$
 $? \text{ g P} \rightarrow 31$

Mass of pure P for each 1 gram of $\text{HNa}_2\text{O}_4\text{P} \cdot 12\text{H}_2\text{O}$ is then: $(31 \times 1) / 358.14 = 0.087 \text{ g}$. Thus, phosphorus makes up only 0.087 g of each gram of $\text{HNa}_2\text{O}_4\text{P} \cdot 12\text{H}_2\text{O}$.

The mass of pure P needed, was afterwards calculated by multiplying the target concentration (150 $\mu\text{g/L}$) by total capacity, for each flume/drum set subjected to the high P treatment. Finally, this calculated P mass was divided by 0.087, to get the amount of $\text{HNa}_2\text{O}_4\text{P} \cdot 12\text{H}_2\text{O}$ to be added to the flumes in order to achieve the target concentration. All necessary values calculated for each flume/drum set can be found in appendix 5.

| | 1 | 2 | 3 | 4 | 5 | 6 | 7 | 8 |
|------------|------|------|------|------|------|-----|-----|------|
| CLAY | High | Low | High | Low | High | Low | Low | High |
| PHOSPHORUS | Low | High | Low | High | High | Low | Low | High |

Fig. 3 Diagram of the experimental design. Each of the 8 flumes is randomly subjected to one of the four clay-phosphorus treatments. There are two replicates per treatment.

2.4 Field work

2.4.1 Tile and leaf bag preparations

Before the beginning of the experiment, 48 unglazed tiles (10×10×2 cm) were soaked in a chlorine solution for 24 hours, then scrubbed thoroughly and rinsed to remove all traces of contamination (appendix 6.1). In addition, 96 leaf bags were made using fine (0.5×0.5 mm) and coarse (2×2 mm) mesh. 48 squares (18×30 cm) were cut out from fine mesh and the sides

either glued with a glue gun, or sewed with a thin polyester thread, to obtain the 18×15 cm bags. 48 other bags of similar dimension were made from coarse mesh, using the same technique. Each bag was afterwards filled with 5 g of dry alder leaves. Alder leaves were collected from an alder tree in the riparian zone of the Solberg River, washed then dried in an oven (Type TS 11, 220V, 750W; Termaks), prior to use. Fine mesh was used to prevent invertebrates from accessing and consuming leaves, whereas coarse mesh was used to allow access of invertebrates. Coarse mesh bags were in addition punctured to make 5 holes (1 cm diameter each), on both sides, to facilitate entry of larger invertebrates (appendix 6.2).

On day 0, each flume received six similar assemblages that consisted of an unglazed tile and a set of two adjacent leaf bags. The set of leaf bags included one bag made of fine mesh and another of coarse mesh. The tile/leaf bag assemblages were fixed on top of the “riffle” sequences across flumes, with tiles upstream from the leaf bag set (Fig. 2b).

2.4.2 *Sampling of tiles and leaf bags*

As soon as the tiles were placed in the flumes on day 0, and prior to the addition of clay and P, the biomass of green algae, cyanobacteria and diatoms was measured at 4 sequential positions across each tile, using a bbe BenthosTorch (Fig. 2b), a portable device that quantifies fluorescence of chlorophyll a *in situ*. Recorded initial values of chlorophyll a were low and were later subtracted from values obtained at sampling events. This conservative measure reduces the risk of overestimating final BenthosTorch readings for algal biomass.

Throughout the six weeks of experiment, a single random tile/leaf bag assemblage was sampled, from one random locality across each flume, on days 6, 12, 18, 24, 30 and 36. At each sampling event, the biomass of green algae, cyanobacteria and diatoms was measured across the tile with the bbe BenthosTorch. Next, both tile and leaf bags were lifted quickly under a 0.063 mm sieve and gently washed, with the sieve underneath, to trap falling invertebrates. Tiles were afterwards scraped with a razor, to collect algae samples and store them in 4% formalin until taxonomic identification. Leaf bags were thereafter, dried in an oven (Type TS 11, 220V, 750W; Termaks) at 100°C for 4 hours. Remaining dry leaves, in both coarse and fine mesh bags, were weighed (PA2102, 2100g×0.01g; Ohaus Pioneer Precision Balance) and the results subtracted from the originally added 5 g of dry alder leaves. The final values obtained for fine mesh bags, corresponded to the amount of leaves decomposed by microbes. These were then converted to the percentage of leaf litter degraded by microbes. The final values obtained for coarse mesh bags, corresponded to the amount of leaves degraded by the action of both microbes and invertebrates. These measurements were

then deducted from those obtained for fine mesh bags and converted to percentage of leaf litter consumed by invertebrates.

2.4.3 Physicochemical properties of water

Current velocity was measured on a transect similar across all flumes, with an electromagnetic current meter (OTT MF pro). Physicochemical water quality indicators were also measured at each sampling event in each flume (upstream end). These included conductivity ($\mu\text{S}/\text{cm}$), pH, salinity (ppt) and temperature ($^{\circ}\text{C}$) (WTW pH/Cond 340i meter), as well as dissolved oxygen (mg/L) (WTW Oxi 330i oxygen meter). Total suspended solids (TSS in mg/L) was measured 2 hours (starting day 13) and 24 hours after spiking (starting day 7), using photometric method (Hach DR 3900 Spectrophotometer without RFID), in an attempt to quantify the effect of clay treatment and clay deposition in flumes.

Conductivity ($\mu\text{S}/\text{cm}$) was also measured 2 hours and 24 hours after spiking (starting day 13), in an attempt to quantify the effect of P treatment and P uptake by the biota. Furthermore, water samples were collected 24 hours after spiking on day 0 and 2 hours after spiking on days 19 and 31. These were kept cool and in the dark, until transport to the laboratory, at NIVAs head office in Oslo, for total phosphorus (TP in $\mu\text{g P}/\text{L}$) analysis. TP analysis in the NIVA laboratory, consists of adding sulfuric acid and peroxydisulfate to the water sample. Peroxydisulfate then converts inorganic phosphates and organically-bound phosphorus into orthophosphate, which then reacts with the sulfuric acid to yield a colorful complex. This complex can be analyzed photometrically, using a Skalar auto-analyzer, to determine the TP concentration in the sample (Haande & Rohrlack, 2005).

2.5 Laboratory procedures

2.5.1 Algal community

A single slide was prepared for each algal sample, to be examined under the microscope (SM-LUX, Leitz). Algae were picked up from the bottom of each sampling bottle with a pincette and placed on the microscopic slide. One or two drops of water were then added to the slide, before covering with the cover slip (18 \times 18 mm).

All algal taxa were identified at 40 \times magnification to the genus level, except for diatoms and an unknown filamentous pseudo-branched cyanobacterium (F. P. Cyanobacterium) (appendix 7). The identified genera were then grouped based on growth form, as follows: adnate (apically attached but parallel to the substrate), or prostrate (entirely adhering to the

substrate); erect (apically attached but perpendicular to the substrate), or with mucilaginous stalks; motile (fast moving); filamentous; and metaphyton (algae without a fixation structure). The classification was mainly based on Piggott, Lange, Townsend, and Matthaei (2012); Piggott et al. (2015); and Schneck, Schwarzbald, and Melo (2011). However, some algal genera were classified according to our own observations and mode of reasoning (Table 1). Ciliates and bacteria were also found and accounted for in the analysis. Abundances of algal taxa, bacteria and ciliates, were estimated in each slide on a five-point scale: 1 = very rare, 2 = occasional, 3 = common, 4 = abundant, 5 = very abundant, predominant (Lorenz, Korte, Sundermann, Januschke, & Haase, 2012).

Estimated abundances were then used as a proxy for individual taxon densities. In addition, the percent abundance for each algal growth form per tile, taxon richness per tile and Shannon's index of diversity and evenness (Begon, Townsend, & Harper, 2006), were calculated (diatoms excluded from these analyses). Menhinick's index (D_{Mn}) was used as a base for taxon richness, measured as the total number of taxa in the sample (S) divided by the square root of the total number of counted individual organisms in the sample (N): $D = S/\sqrt{N}$.

Table 1. Algal classification according to growth form.

(1) Adnate or prostrate

Species of *Gloeocystis*

(2) Erect or with mucilage stalks

Species of *Asterococcus**, *Calothrix**, *Coelastrum**, *Coenocystis**, *Dictyosphaerium**, *Eutetramorus**, *Gomphosphaeria**, *Microcystis**

(3) Filamentous

Species of *Anabaena*, *Cladophora*, *Mougeotia**, *Oedogonium*, *Oscillatoria*, *Spirogyra*, *Stigeoclonium*, *Teilingia**, *Ulothrix* and a non-identified filamentous cyanobacterium

(4) Metaphyton

Species of *Actinastrum**, *Ankistrodesmus*, *Chlorococcum**, *Chroococcus**, *Closterium*, *Cosmarium*, *Merismopedia*, *Pediastrum*, *Pleurocapsa**, *Scenedesmus*, *Staurastrum*, *Tetraedron**, *Trachelomonas* and *Trebouxia**

* refers to algal genera that were classified based on personal observations and reasoning. No motile genera were found.

The Shannon diversity index (H) was calculated as $H = -\sum_{i=1}^S P_i \ln P_i$, where P_i is the proportion of taxon i relative to S . Shannon's index of evenness (E_H) could afterwards be

obtained by dividing H by H_{max} ($H_{max} = \ln S$). This measure ranges between 0 and 1, with 1 being complete evenness, where all taxa in the sample have equal abundances (Peet, 1974).

2.5.2 *Invertebrate community*

Invertebrates that were trapped in the sieve, were first killed separately based on source (tile or leaf bags), with a 10% ethanol solution of known volume. It is worth noting, that sampling of tiles for invertebrates ceased after day 24, since tiles hosted merely few invertebrates, of the same taxa as those in leaf bags. Following the killing of invertebrates with ethanol, two separate subsamples of the same volume were pipetted for each source (Finnpipette F2, Thermo Fisher Scientific). The main sample was mixed before and after each pipetting event to insure homogenization. The subsamples were thereafter stored in separate sampling bottles in 70% ethanol.

This sampling technique, which allows for an unbiased quantitative analysis of the data, was adopted late, on days 24, 30 and 36. A single subsample was retrieved from each sampling bottle (same as previous technique) and examined under the stereomicroscope (Leica Wild M10, Leica Microsystems), for taxonomic identification. Invertebrate individuals were counted and identified at 32 \times magnification, to the lowest practical taxonomic level. The whole sample was also examined at 16 \times magnification and the entirety of uncommon individuals identified and counted. Thereafter, total density and individual taxon density were calculated. In addition, taxon richness per set of leaf bags and Shannon's index of diversity and evenness were estimated in the same way as for the algal community. Biomass of the common invertebrate taxa was calculated as dry weight, by taking a representative sample of a specific taxon (up to 40 individuals) and drying it to a constant weight in an oven (up to 2 hours) at 105°C. The dried sample was afterwards weighed (PA2102, 2100g \times 0.01g; Ohaus Pioneer Precision Balance) and the biomass of the whole population for that specific taxon was calculated.

2.6 **Statistical analysis**

All statistical analyses and graphic illustrations were performed in R Studio, version R 3.2.3. Algal, leaf decomposition and invertebrate response variables were tested for normality using the Shapiro-Wilk test. When possible, response variables were transformed to satisfy assumptions of homoscedasticity and normality. Clay and phosphorus were fixed main factors; sampling week and flume were fixed blocking factors.

For parametric data, we used the following nested analysis of variance (ANOVA) model: intercept+ clay+ phosphorus+ clay × phosphorus+ sampling week+ flume “nested in” (clay+ phosphorus) + error. Adding sample position (1-6 positions in each flume) to the model, as a nested factor in flume, resulted in a perfect-fitted model without error. A perfect fit implies that the gathered data is perfect, which is highly dubious, simply because the sampling process is essentially imperfect (Babyak, 2004). As such, ANOVA F-tests on an essentially perfect fit are unreliable (Welham, Gezan, Clark, & Mead, 2014) and sample position was consequentially removed from the analysis.

Since the experimental design was balanced and hierarchically nested, Type I sums of squares was applied (Hill & Lewicki, 2006). Tukey’s multiple comparison test was implemented, for clay and phosphorus, where groups were significantly different. In the case of non-parametric data, Wilcoxon signed-rank test was applied. We used a significance level $\alpha = 0.05$ for hypothesis testing.

Although a Bonferroni-type adjustment of significance levels for multiple testing serves to keep the family-wise Type I error rate at or below α , it is however considered too conservative because it reduces power for each comparison test (Garcia, 2004; Perneger, 1998; Quinn & Keough, 2002). As an alternative, standardized effect sizes were estimated. Partial eta squared values ($\eta_p^2 = SS_{\text{effect}} / (SS_{\text{effect}} + SS_{\text{error}})$) were calculated for significant findings in ANOVA (Fritz, Morris, & Richler, 2012; Piggott et al., 2012) and the r proposed by Cohen (1988) ($r = z / (\sqrt{N})$), was calculated for significant findings in Wilcoxon (as cited in Fritz et al., 2012). In case of a significant interaction, main effects may still be of biological importance but also difficult to interpret. Thus, only main effects whose effect size was larger than that of the interaction term were interpreted (Quinn & Keough, 2002).

Interactions between clay and P were, furthermore, classified directionally into three main categories as in Piggott et al. (2015): additive, antagonistic and synergistic. In the case of an additive effect, there is no significant interaction between the two stressors. However, the main effects of clay and P can be of the same direction (positive or negative) and add up when both stressors are combined, or of different directions and oppose each other. In the case of antagonistic and synergistic effects, the interaction term is statistically significant. An interaction is positive antagonistic (+A), if its effect is less positive than the additive sum of effects produced by the stressors acting in isolation. When it is less negative than predicted additively, then it is negative antagonistic (-A). If the effect of the interaction is more positive

than the sum of main effects, then it is positive synergistic (+S). If it is more negative than predicted additively, then it is negative synergistic (-S).

Furthermore, non-metric multidimensional scaling (NMDS) was applied to depict similarities/dissimilarities between taxa, in response to clay-phosphorus treatments, for each of the invertebrate and algal communities, including algal growth forms. The Bray-Curtis coefficient was used as a distance measure. Bray-Curtis distances are computed using the formula $1 - (2W / (A + B))$ where A and B are the sums of abundances of taxa found in each treatment and W is the sum of shared taxa in both treatments (Bray & Curtis, 1957). NMDS then places each object of the resultant distance matrix, in a space with a specified number of dimensions N, such that the between-object distances are conserved to the greatest possible degree. Ordination points are adjusted in a manner that minimizes “stress” and the appropriate number of dimensions can be chosen by looking at “stress” (Legendre & Legendre, 2012). Two dimensions well described our data after examining “stress” for different dimensions (appendix 8). Function ‘metaMDS’ from the ‘vegan’ package, version 2.3-5, was used to compute NMDS.

A one-way ANOSIM (Analysis of similarities) was finally conducted to test the null hypothesis of no difference in community composition between combined clay and P treatments, for each of the invertebrate and algal communities, including algal growth forms. A dissimilarity matrix based on Bray-Curtis distances was first made, using the function ‘vegdist’ in the R package ‘vegan’. This matrix was then evaluated with the ‘anosim’ function in package ‘vegan’. ANOSIM compares the mean of ranked dissimilarities between groups, to the mean of ranked dissimilarities within groups. The test produces an overall P-value and a test statistic R. If the P-value is below 0.05, then there is a significant difference between groups (treatments). The test statistic R can lie between -1 and 1. An R value close to 0 represents the null hypothesis of no difference between groups (dissimilarities are greater within groups than between groups), whereas a value close to 1 indicates a significant difference between groups (Clarke & Warwick, 2001).

3 Results

3.1 Physicochemical properties of water

Weekly measures of conductivity, salinity, dissolved oxygen, pH and temperature, as well as measures of current velocity, were similar across treatments (Table 2). Mean TSS

concentrations achieved in the flumes subjected to high levels of clay, were almost double the concentrations in flumes subjected to low levels of clay. All TSS concentrations, except those recorded for the “high P low clay” treatment, were furthermore significantly lower 24 h after spiking compared to 2 h after spiking (Fig. 4, Table 2). However, conductivity recorded 2 h after spiking, did not differ from that recorded 24 h after spiking and was similar across treatments (Table 2). Nevertheless, significantly higher mean TP concentrations were found for high P treatments, compared to low P treatments (Fig. 4, Table 2). Mean TP concentrations recorded were 33.8 ± 4.5 $\mu\text{g P/L}$ and 35.3 ± 8.5 $\mu\text{g P/L}$ (standard error; $n=6$) for the low P treatments. Whereas the achieved mean TP concentrations for high P treatments were 141 ± 22.3 $\mu\text{g P/L}$ and 146.7 ± 22.6 $\mu\text{g P/L}$ (standard error; $n=6$) (Table 2).

Table 2. Summary statistics of measured abiotic and biotic parameters.

| Response variables | n | Treatment | | | |
|------------------------------|----|---------------|---------------|---------------|----------------|
| | | Low P: Low S | Low P: High S | High P: Low S | High P: High S |
| Taxon-level variables | | | | | |
| Algal taxon densities | 12 | | | | |
| <i>Actinastrum</i> | | 0 | 0.1 ± 0.1 | 0 | 0 |
| <i>Anabaena</i> | | 1.1 ± 0.3 | 0.2 ± 0.1 | 0.5 ± 0.1 | 2.1 ± 0.6 |
| <i>Ankistrodesmus</i> | | 3 | 3 | 3 | 3 |
| <i>Asterococcus?</i> | | 0.6 ± 0.1 | 0.6 ± 0.2 | 0.2 ± 0.1 | 0.2 ± 0.1 |
| <i>Calothrix</i> | | 0 | 0 | 0.1 ± 0.1 | 0.1 ± 0.1 |
| <i>Chlorococcum</i> | | 2.9 ± 0.1 | 3 | 2.9 ± 0.1 | 3 |
| <i>Chroococcus</i> | | 2.7 ± 0.2 | 2.4 ± 0.3 | 2.4 ± 0.3 | 2.7 ± 0.2 |
| <i>Cladophora</i> | | 2 ± 0.6 | 1.2 ± 0.4 | 2.1 ± 0.5 | 2.7 ± 0.6 |
| <i>Closterium</i> | | 2.3 ± 0.4 | 2.1 ± 0.3 | 1.4 ± 0.3 | 2.2 ± 0.2 |
| <i>Coelastrum</i> | | 3.2 ± 0.2 | 3.2 ± 0.2 | 2.8 ± 0.2 | 3 ± 0.2 |
| c.f. <i>Coenocystis</i> | | 2.2 ± 0.2 | 2 ± 0.2 | 1.2 ± 0.2 | 1.3 ± 0.3 |
| <i>Cosmarium</i> | | 3.8 ± 0.2 | 4.5 ± 0.2 | 3 ± 0.2 | 3.8 ± 0.3 |
| Diatoms | | 5 | 5 | 5 | 5 |
| <i>Dictyosphaerium?</i> | | 0.6 ± 0.2 | 0.4 ± 0.1 | 0.7 ± 0.3 | 1.1 ± 0.3 |
| c.f. <i>Eutetramorus</i> | | 0.4 ± 0.3 | 0.3 ± 0.2 | 0.2 ± 0.1 | 0.9 ± 0.3 |
| F. P. Cyanobacterium | | 0.3 ± 0.1 | 0.1 ± 0.1 | 0.2 ± 0.1 | 0.1 ± 0.1 |
| <i>Gloeocystis</i> | | 1.1 ± 0.2 | 0.7 ± 0.2 | 0.7 ± 0.1 | 0.5 ± 0.1 |
| <i>Gomphosphaeria</i> | | 1.6 ± 0.4 | 2 ± 0.4 | 0.7 ± 0.1 | 1 ± 0.3 |
| <i>Merismopedia</i> | | 3.1 ± 0.1 | 2.8 ± 0.2 | 2.8 ± 0.2 | 3 |
| c.f. <i>Microcystis</i> | | 2.2 ± 0.5 | 1.9 ± 0.5 | 2 ± 0.4 | 1.8 ± 0.4 |
| <i>Mougeotia</i> | | 2.8 ± 0.3 | 2.7 ± 0.2 | 2.7 ± 0.5 | 3.7 ± 0.3 |
| <i>Oedogonium</i> | | 4.1 ± 0.4 | 3.1 ± 0.5 | 4 ± 0.5 | 3 ± 0.6 |
| <i>Oscillatoria</i> | | 2.2 ± 0.4 | 2.1 ± 0.3 | 3.1 ± 0.5 | 3.7 ± 0.3 |
| <i>Pediastrum</i> | | 2.8 ± 0.2 | 2.2 ± 0.3 | 1.9 ± 0.2 | 1.9 ± 0.3 |
| <i>Pleurocapsa?</i> | | 0.9 ± 0.3 | 0.7 ± 0.2 | 0.9 ± 0.3 | 1.2 ± 0.3 |
| <i>Scenedesmus</i> | | 3.9 ± 0.2 | 4.1 ± 0.2 | 3.7 ± 0.2 | 3.5 ± 0.2 |
| <i>Spirogyra</i> | | 0.2 ± 0.1 | 0.2 ± 0.1 | 0.2 ± 0.1 | 0.5 ± 0.1 |
| <i>Staurastrum</i> | | 2 ± 0.2 | 2.1 ± 0.3 | 0.9 ± 0.1 | 2.2 ± 0.4 |

| | | | | | |
|---|----|---------------------|----------------|----------------|----------------------|
| <i>Stigeoclonium</i> | | 1.2 ± 0.5 | 0.2 ± 0.1 | 0.7 ± 0.2 | 1 ± 0.4 |
| <i>Teilingia</i> | | 0.8 ± 0.3 | 0.7 ± 0.2 | 0 | 0.5 ± 0.2 |
| <i>Tetraedron</i> | | 3 | 2.8 ± 0.1 | 2.3 ± 0.3 | 2.8 ± 0.1 |
| <i>Trachelomonas</i> | | 0 | 0.1 ± 0.1 | 0 | 0.1 ± 0.1 |
| <i>Trebouxia??</i> | | 0 | 0 | 0 | 0.2 ± 0.1 |
| <i>Ulothrix</i> | | 0.3 ± 0.1 | 0 | 0 | 0.6 ± 0.2 |
| Bacteria density | 12 | 0.7 ± 0.1 | 0.7 ± 0.1 | 0.7 ± 0.1 | 0.7 ± 0.1 |
| Ciliata density | 12 | 1.4 ± 0.3 | 1.2 ± 0.2 | 2 ± 0.3 | 2 ± 0.3 |
| Invertebrate biomass (mg) | 6 | | | | |
| Chironomidae | | 114.4 ± 21.9 | 140.9 ± 40.2 | 65.9 ± 16.5 | 62.5 ± 25.5 |
| Cladocera | | 40.1 ± 6.9 | 43.9 ± 13.4 | 22.3 ± 4.1 | 14.5 ± 3 |
| Copepoda | | 204.2 ± 35.1 | 223.7 ± 68.1 | 113.8 ± 20.8 | 74 ± 15.2 |
| Oligochaeta | | 106.5 ± 32.9 | 44.1 ± 11.9 | 85.5 ± 20.6 | 88.5 ± 35 |
| Planorbidae | | 1927.3 ± 369.5 | 2373.2 ± 678.2 | 1110 ± 278.1 | 1053.2 ± 429.1 |
| Invertebrate density | 6 | | | | |
| Chironomidae | | 73.3 ± 14.1 | 90.3 ± 25.8 | 42.2 ± 10.6 | 40.1 ± 16.3 |
| Cladocera | | 252.1 ± 43.4 | 276.2 ± 8 | 140.5 ± 25.7 | 91.4 ± 18.7 |
| Copepoda | | 1.9 ± 0.4 | 2 ± 0.5 | 1.7 ± 0.4 | 2.2 ± 0.3 |
| Ephemeroptera | | 0 | 0.1 ± 0.1 | 0.04 ± 0.04 | 0 |
| Oligochaeta | | 59.1 ± 18.3 | 24.5 ± 6.6 | 47.5 ± 11.4 | 49.1 ± 19.4 |
| Planorbidae | | 5.9 ± 3.4 | 0.5 ± 0.2 | 0.04 ± 0.04 | 0.04 ± 0.04 |
| Pulmonata | | 0 | 0 | 0 | 0.04 ± 0.04 |
| Temnocephalida | | 0.04 ± 0.04 | 0 | 0.4 ± 0.2 | 0.2 ± 0.2 |
| Turbellaria | | 0 | 0.04 ± 0.04 | 1 ± 1 | 0 |
| Community-level variables | | | | | |
| Algal biomass (Chl a in µg/cm ²) | 12 | | | | |
| Cyanobacteria | | 0.2 ± 0.1 | 0.2 ± 0.04 | 0.4 ± 0.1 | 0.4 ± 0.1 |
| Diatoms | | 1.6 ± 0.3 | 1.4 ± 0.3 | 1.7 ± 0.2 | 2.2 ± 0.4 |
| Green algae | | 0.2 ± 0.1 | 0.3 ± 0.1 | 0.4 ± 0.1 | 0.2 ± 0.1 |
| Total algal biomass | | 2.1 ± 0.3 | 1.9 ± 0.2 | 2.5 ± 0.3 | 2.9 ± 0.4 |
| Algal growth form (%) | 12 | | | | |
| Adnate or prostrate | | 1.9 ± 0.4 | 1.3 ± 0.5 | 1.5 ± 0.3 | 0.9 ± 0.3 |
| Erect or stalked | | 18.7 ± 1.3 | 20.3 ± 1.3 | 17.1 ± 0.6 | 16.3 ± 1 |
| Filamentous | | 26.2 ± 2.4 | 19.7 ± 2.3 | 26.2 ± 3.1 | 30.5 ± 1.6 |
| Metaphyton | | 53.1 ± 1.7 | 58.7 ± 1.9 | 55.2 ± 2.8 | 52.2 ± 1.8 |
| Algal community | | | | | |
| Evenness | 12 | 0.96 ± 0.001 | 0.96 ± 0.001 | 0.95 ± 0.003 | 0.96 ± 0.001 |
| Shannon diversity | 12 | 3 ± 0.02 | 2.9 ± 0.03 | 2.86 ± 0.05 | 2.96 ± 0.03 |
| Taxon richness | 12 | 2.9 ± 0.1 | 2.8 ± 0.05 | 2.9 ± 0.1 | 2.9 ± 0.1 |
| Invertebrate community | | | | | |
| Evenness | 6 | 0.6 ± 0.02 | 0.4 ± 0.04 | 0.6 ± 0.05 | 0.6 ± 0.04 |
| Shannon diversity | 6 | 0.9 ± 0.03 | 0.7 ± 0.05 | 0.9 ± 0.1 | 0.9 ± 0.1 |
| Taxon richness | 6 | 0.04 ± 0.01 | 0.05 ± 0.01 | 0.05 ± 0.004 | 0.06 ± 0.005 |
| Total density | 6 | 392.4 ± 66.8 | 393.4 ± 87 | 232.1 ± 28.4 | 182.9 ± 40 |
| Leaf litter degradation (%) | | | | | |
| Invertebrate consumption | | 8.1 ± 1.8 (n=10) | 6 ± 1.9 (n=10) | 9.7 ± 2 (n=10) | 10.2 ± 3.8 (n=12) |

| | | | | | |
|-----------------------------------|----|----------------------|----------------------|--------------------|----------------------|
| Microbial decomposition | | 32.5 ± 3.5 (n=10) | 32.9 ± 3.5 (n=11) | 38 ± 4.9 (n=10) | 30.5 ± 2.8 (n=12) |
| Abiotic variables | | | | | |
| Conductivity (µS/cm) | | | | | |
| Weekly sampling | 12 | 174.7 ± 8.9 | 178.6 ± 8.3 | 177.4 ± 8.9 | 176.6 ± 9.1 |
| 2 h after spiking | 8 | 160.6 ± 9.3 | 165.3 ± 8.3 | 165.4 ± 8.9 | 165.4 ± 9.7 |
| 24 h after spiking | 8 | 159.1 ± 10.5 | 163.8 ± 9.6 | 164.4 ± 10.3 | 164.7 ± 11 |
| Dissolved oxygen (mg/L) | 12 | 9.9 ± 0.2 | 10 ± 0.3 | 10.1 ± 0.3 | 10 ± 0.2 |
| pH | 12 | 8.2 ± 0.1 | 8.2 ± 0.04 | 8.6 ± 0.1 | 8.5 ± 0.1 |
| Salinity (ppt) | 12 | 0 | 0 | 0 | 0 |
| Temperature (°C) | 12 | 16.3 ± 1 | 16 ± 1 | 15.9 ± 1 | 16.3 ± 1 |
| Total phosphorus (TP) (µg P/L) | 6 | 33.8 ± 4.5 | 35.3 ± 8.5 | 141 ± 22.3 | 146.7 ± 22.6 |
| Total suspended solids (mg/L) | | | | | |
| 2 h after spiking | 8 | 8.7 ± 0.9 | 19.2 ± 2.1 | 7.5 ± 1.8 | 20.2 ± 1.6 |
| 24 h after spiking | 10 | 6.3 ± 0.8 | 10.7 ± 1.7 | 5.3 ± 1 | 9.6 ± 1.3 |
| Velocity (cm/s) | 12 | 5.2 ± 0.2 | 5.5 ± 0.3 | 5.4 ± 0.3 | 5.7 ± 0.3 |

Response variables are summarized by factor treatment, where “P” and “S” are abbreviations for phosphorus and clay respectively. All values are written as mean ± standard error of mean (SE). n is sample size per treatment group and is shown in parentheses in the case where sample size varies per treatment group. Measurements of both conductivity and total suspended solids (TSS) are also summarized by factor “hours after spiking” (2 h versus 24 h).

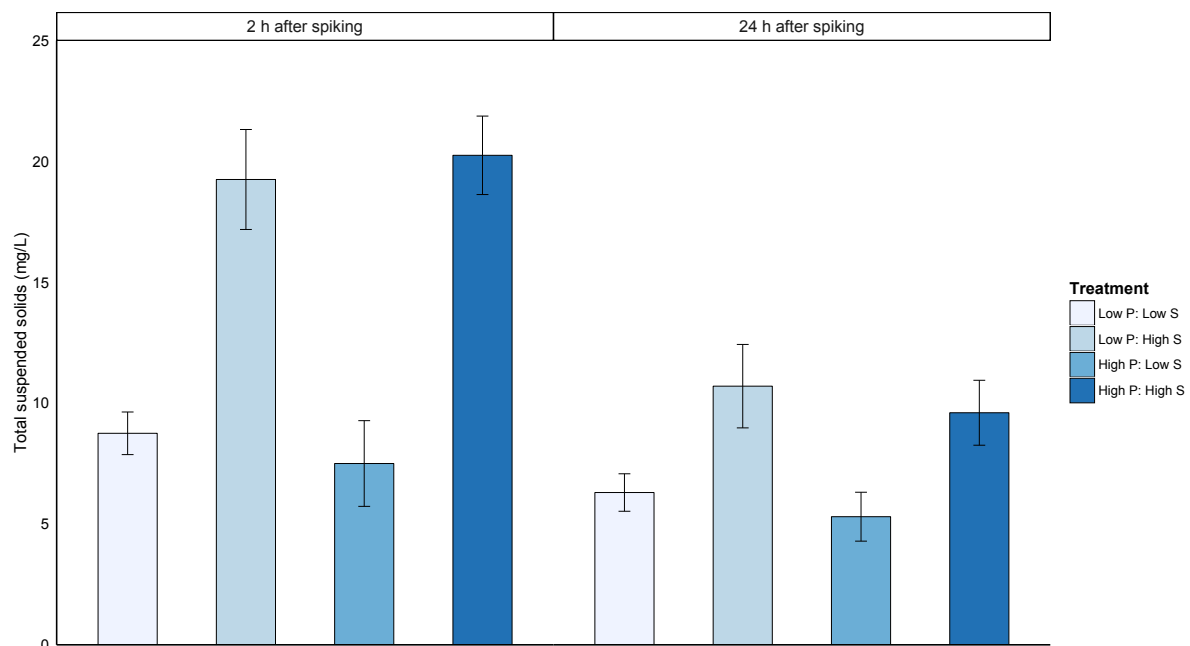

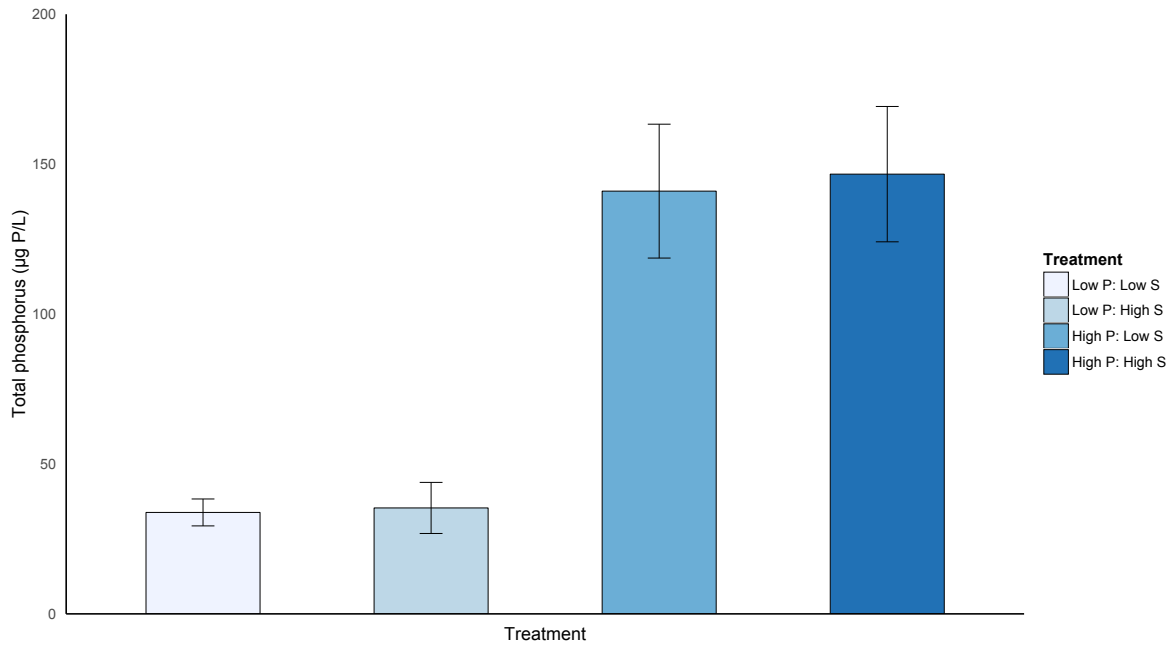

Fig. 4 Average variations of TSS and TP concentrations in response to combined clay and phosphorus treatments (mean \pm SE). TSS concentrations are further summarized by factor “hours after spiking” (2 h versus 24 h).

3.2 Algae

The algal community was made up of a total of 32 algal genera, in addition to diatoms and an unidentified filamentous pseudo-branched cyanobacterium (F. P. Cyanobacterium) (Table 2). P addition increased total algal biomass, including the biomass of both cyanobacteria and diatoms. With regard to algal growth forms, erect or stalked algae generally decreased with added P while filamentous forms increased (Table 3, appendix 9.1).

P also affected metaphyton forms via an interaction with clay (Fig. 5a, Table 3). Clay had a positive effect on metaphyton under low phosphorus but not under high phosphorus. Thus, added phosphorus masked the effect of clay (positive antagonistic P \times clay interaction). At the taxon level, P addition increased Ciliata and *Oscillatoria* densities and decreased densities of c.f. *Coenocystis*, *Cosmarium*, *Gomphosphaeria*, *Pediastrum*, *Staurastrum*, and finally *Teilingia* (Table 3, appendix 9.1). Clay addition supplementarily increased *Cosmarium* density, while interacting with P in an additive way to neutralize its negative effect (Fig. 5b, Table 3). Combined clay and P further interacted additively to decrease *Pediastrum* density (Fig. 5c, Table 3).

Although the outcome of the ANOSIM test for the algal community, was a test statistic $R > 0$ and a P-value < 0.05 , the plot did not show any clear distinction between the different

Table 3. Leaf litter degradation and algal responses to combined clay and phosphorus treatments.

| Response variables | Clay | Ranking | Phosphorus | Ranking | Clay × Phosphorus | Direction |
|----------------------------------|---------------------|---------|----------------------|---------|--------------------|-----------|
| Taxon-level variables | | | | | | |
| Taxon densities | | | | | | |
| Ciliata | | | 0.02 (0.32) | H > L | | |
| c.f. <i>Coenocystis</i> | | | 0.001 (0.46) | L > H | | |
| <i>Cosmarium</i> | 0.009 (0.37) | H > L | 0.007 (0.38) | L > H | | AD |
| <i>Gomphosphaeria</i> | | | 0.01 (0.36) | L > H | | |
| <i>Oscillatoria</i> | | | 0.003 (0.43) | H > L | | |
| <i>Pediastrum</i> | | | 0.03 (0.31) | L > H | | AD |
| <i>Staurastrum</i> | | | 0.04 (0.28) | L > H | | |
| <i>Teilingia</i> | | | 0.01 (0.37) | L > H | | |
| Community-level variables | | | | | | |
| Algal biomass | | | | | | |
| Cyanobacteria (sqrt) | | | 0.0001 (0.36) | H > L | | |
| Diatoms (sqrt) | | | 0.009 (0.18) | H > L | | |
| Total algal biomass | | | 0.001 (0.24) | H > L | | |
| Algal growth form | | | | | | |
| Erect/stalked (log) | | | 0.006 (0.19) | L > H | | |
| Filamentous | | | 0.01 (0.34) | H > L | | |
| Metaphyton (log) | | | | | 0.01 (0.16) | +A |
| Leaf litter degradation | | | | | | |
| Invertebrate consumption (sqrt) | | | | | | |
| | | | 0.02 (0.22) | H > L | | |
| Microbial decomposition | | | | | | |
| | 0.02 (0.15) | * | | | 0.01 (0.18) | +A |

Summary of the nested ANOVA model and Wilcoxon signed-rank tests comparing differences between groups for different treatments. Only significant results are shown here, with significant P-values (≤ 0.05) given in bold. Respective effect sizes are shown in parentheses. The interaction effect is classified directionally (+ or -) as either antagonistic (A), synergistic (S), or additive (AD; no interaction). Rankings of main effects are based on significant post hoc Tukey and Wilcoxon tests: L, low; H, high. Post hoc rankings are not conducted when the effect size of the interaction term is larger than the size of the corresponding main effect. In this case rankings are replaced by ‘*’.

treatments (Fig. 6a). However, based on the ordination plot, added P clearly had the greatest effect on the algal community (Fig. 6b). In fact, the ellipses of both types of P-enriched treatments overlapped significantly, which meant that they had similar effects on the algal community. Nevertheless, out of the two P-rich treatments, only the “high P low clay” combination, was significantly different from the two low P combinations. This showed that

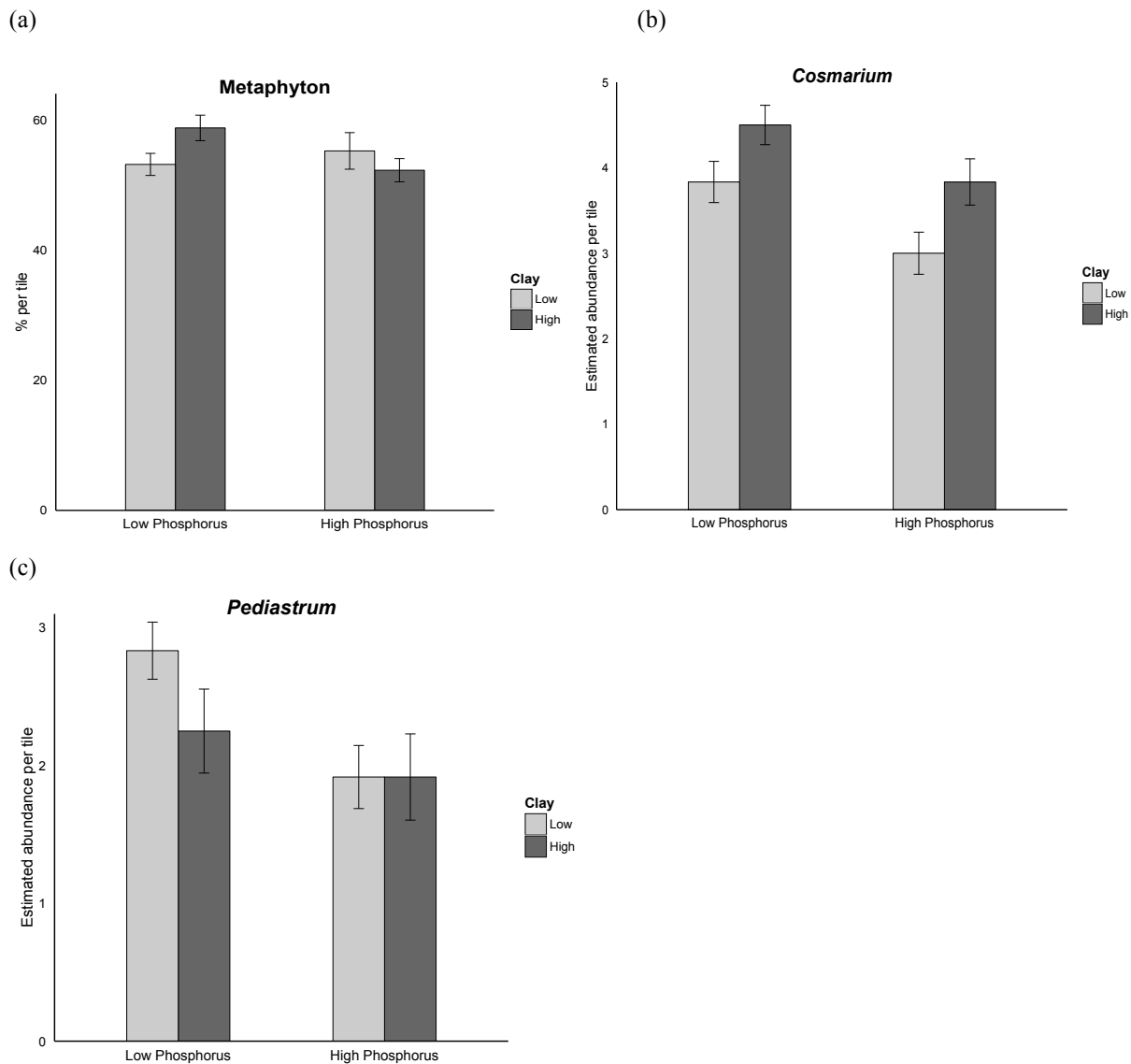
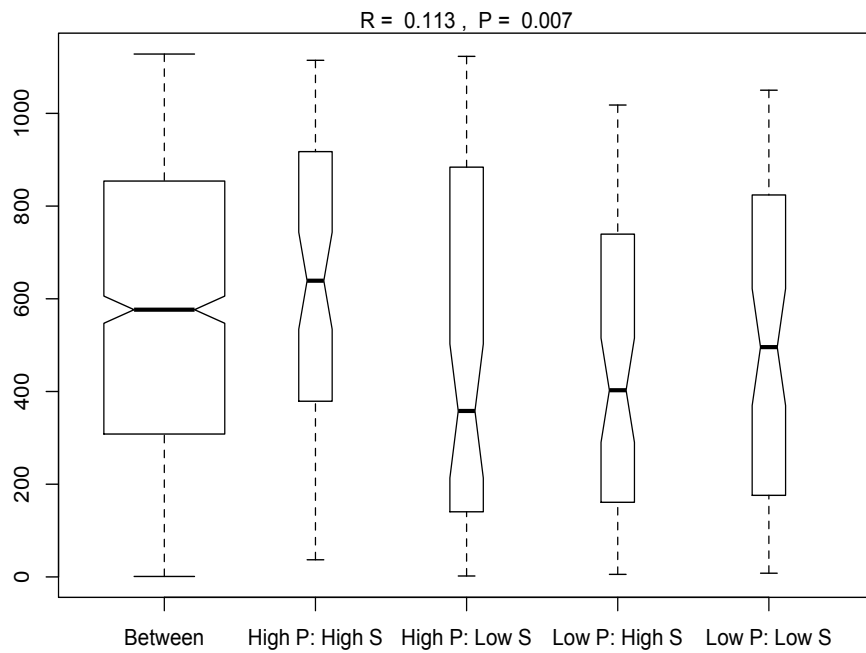

Fig. 5 Average variations of (a) metaphyton abundance; (b) *Cosmarium*; and (c) *Pediastrum* densities in response to combined clay and phosphorus treatments (mean \pm SE).

added clay altered the effects of added P when the two were combined. Otherwise, clay augmentation did not significantly contribute to different effects between treatments.

As for the algal growth forms, ANOSIM results included a test statistic close to 0 and a P-value > 0.05 (Fig. 7a), which meant no significant differences in community composition between combined clay and P treatments for different algal growth forms. This could be observed in the NMDS plot but with one exception: the “high P high clay” and the “low P high clay” combinations did not overlap (Fig. 7b). As such, added P may have altered the effects of added clay on the community composition. Furthermore, metaphyton and erect or stalked algal growth forms overlapped in the NMDS plot. They also appeared closest to the

(a)



(b)

Community structure by treatment

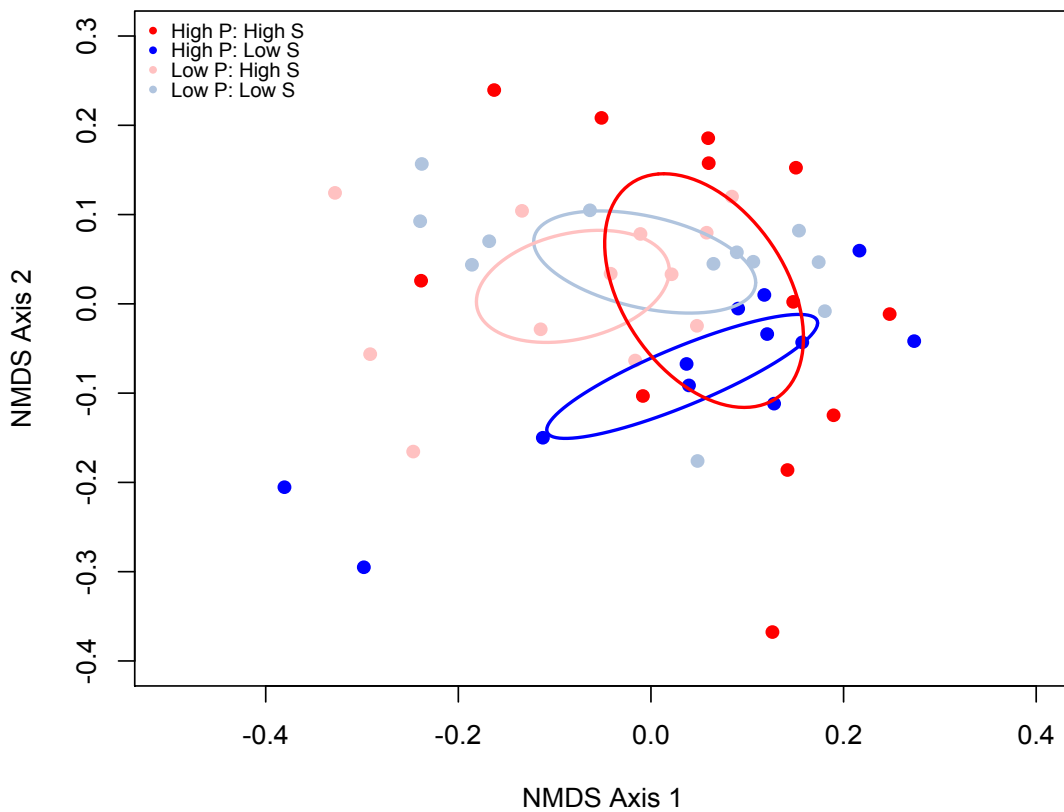
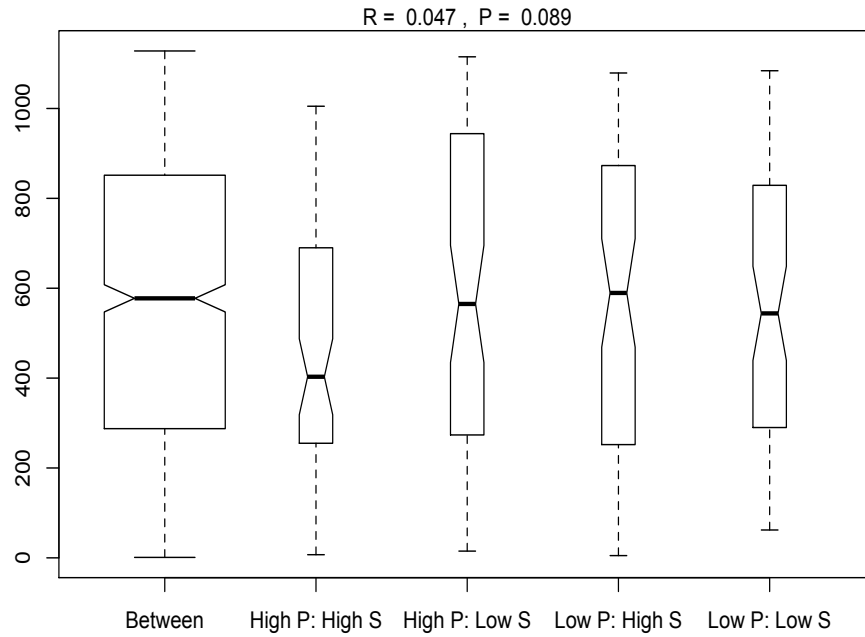

Fig. 6 (a) Boxplot of analysis of dissimilarity ranks (ANOSIM) between and within treatments for the algal community. (b) Two-dimensional NMDS plot (stress score 0.166) of the algal community structure. Circular symbols represent individual samples and ellipses indicate treatment (four combinations of phosphorus P and clay S) means with 95% confidence intervals fitted onto the spatial ordination.

(a)



(b)

Community structure by treatment

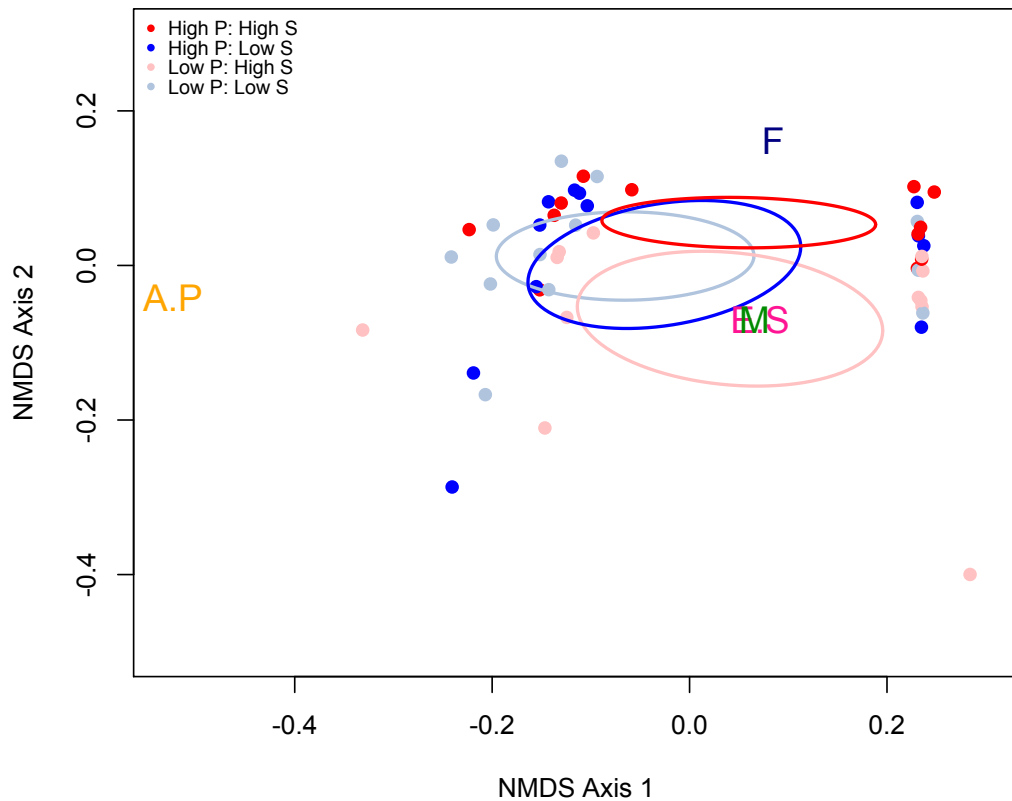

Fig. 7 (a) Boxplot of analysis of dissimilarity ranks (ANOSIM) between and within treatments for the algal growth forms. (b) Two-dimensional NMDS plot (stress score 0.043) of the following algal growth forms: Adnate or prostrate (A.P), erect or stalked (E.S), filamentous (F) and metaphyton (M). Circular symbols represent individual samples and ellipses indicate treatment (four combinations of phosphorus P and clay S) means with 95% confidence intervals fitted onto the spatial ordination.

site of the “low P high clay” treatment. These two growth forms were therefore mostly abundant in samples subjected to that treatment (Fig. 7b, Table 2). Filamentous forms, on the other hand, had the highest abundance in samples subjected to the “high P high clay” treatment (Fig. 7b, Table 2), whereas adnate or prostrate forms were highest in abundance under the “low P low clay” combination (Table 2).

3.3 Invertebrates

The invertebrate community was comprised of a total of 9 taxa (Table 2). Most common taxa were Cladocera, Chironomidae, Oligochaeta, Copepoda and Planorbidae respectively (Table 4). It is useful to mention that nematodes were also found in the samples but were impossible to detect under the stereomicroscope. Consequently, they were not counted due to time constraint.

Total density (comprising 99.84% of the invertebrate community) was significantly lower at high levels of phosphorus (Table 4, appendix 9.2). Oppositely, P addition increased taxon richness, biodiversity as well as evenness (Table 4, appendix 9.2). P also affected biodiversity and evenness via an interaction with clay. Added clay had a negative effect on diversity and evenness under low P treatment but not when combined with P at high levels. Thus, added phosphorus weakened the effect of clay (negative antagonistic P×clay interactions) (Fig. 8a, b, Table 4).

At the taxon level, P addition decreased the biomass and density of Cladocera, Chironomidae and Planorbidae. Copepoda biomass also decreased under high P levels (Table 4, appendix 9.2). Temnocephalida however, showed higher densities under high P treatments compared to low P treatments (Table 2). As for clay addition, it did not affect any of the invertebrates except oligochaetes, by significantly decreasing their biomass (Table 4, appendix 9.2), as well as planorbids, by interacting with P in an additive way to decrease their density (Fig. 8c, Table 4).

Based on the ANOSIM plot, combinations of clay and phosphorus affected the invertebrate community differently (Test statistics $R > 0$ and $P < 0.05$). The largest distinction was between the “high P low clay” treatment and the “low P high clay” treatment (Fig. 9a). This was visible in the NMDS plot as well, with distinct ellipses for both of these treatments (Fig. 9b). However, the ellipses of P-enriched treatments overlapped considerably, which meant that they affected the invertebrate community in a similar way regardless of applied clay levels. Likewise, the remaining low P combinations had an equivalent effect on the

Table 4. Invertebrate responses to combined clay and phosphorus treatments.

| Response variables | % | Clay | Ranking | Phosphorus | Ranking | Clay × Phosphorus | Direction |
|----------------------------------|-------|--------------------|---------|----------------------|---------|--------------------|-----------|
| Taxon-level variables | | | | | | | |
| Chironomidae | 20.45 | | | | | | |
| Biomass (log) | | | | 0.02 (0.31) | L > H | | |
| Density (sqrt) | | | | 0.01 (0.37) | L > H | | |
| Cladocera | 63.21 | | | | | | |
| Biomass (sqrt) | | | | 0.003 (0.46) | L > H | | |
| Density (sqrt) | | | | 0.003 (0.46) | L > H | | |
| Copepoda | 0.65 | | | | | | |
| Biomass (sqrt) | | | | 0.003 (0.46) | L > H | | |
| Oligochaeta | 15 | | | | | | |
| Biomass (log) | | 0.04 (0.25) | L > H | | | | |
| Planorbidae | 0.53 | | | | | | |
| Biomass (log) | | | | 0.02 (0.31) | L > H | | |
| Density | | | | 0.04 (0.42) | L > H | | AD |
| Community-level variables | | | | | | | |
| Evenness | | | | 0.02 (0.3) | H > L | 0.02 (0.3) | -A |
| Shannon diversity | | | | 0.02 (0.33) | H > L | 0.04 (0.25) | -A |
| Total density (log) | 99.84 | | | 0.0008 (0.56) | L > H | | |
| Taxon richness | | | | 0.007 (0.41) | H > L | | |

Summary of the nested ANOVA model and Wilcoxon signed-rank tests comparing differences between groups for different treatments. Only significant results are shown here, with significant P-values (≤ 0.05) given in bold. Respective effect sizes are shown in parentheses. The interaction effect is classified directionally (+ or -) as either antagonistic (A), synergistic (S), or additive (AD; no interaction). Rankings of main effects are based on significant post hoc Tukey and Wilcoxon tests: L, low; H, high. Post hoc rankings are not conducted when the effect size of the interaction term is larger than the size of the corresponding main effect.

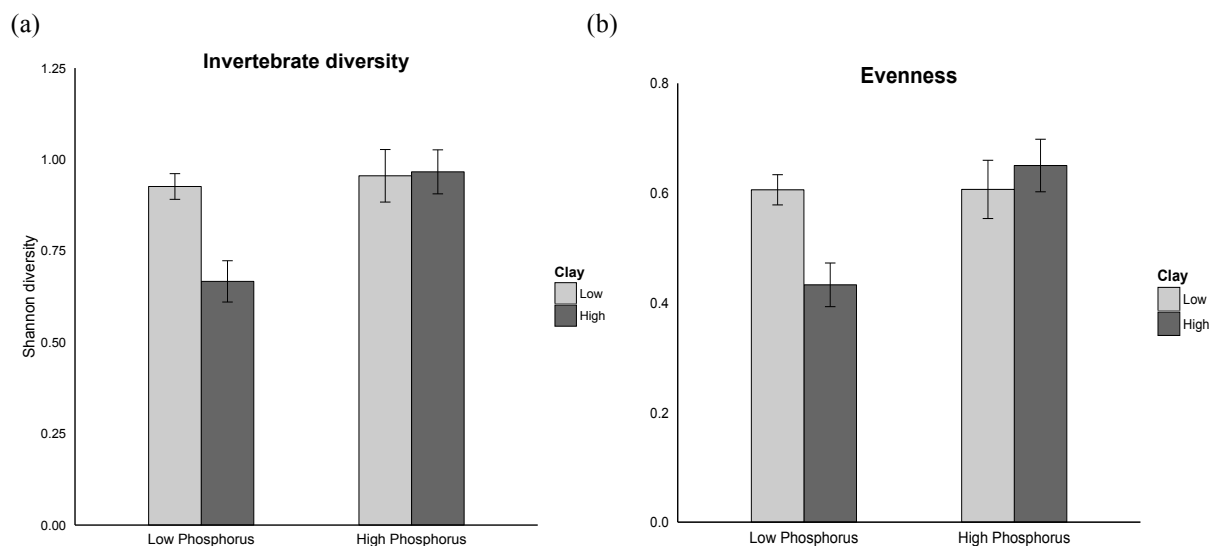

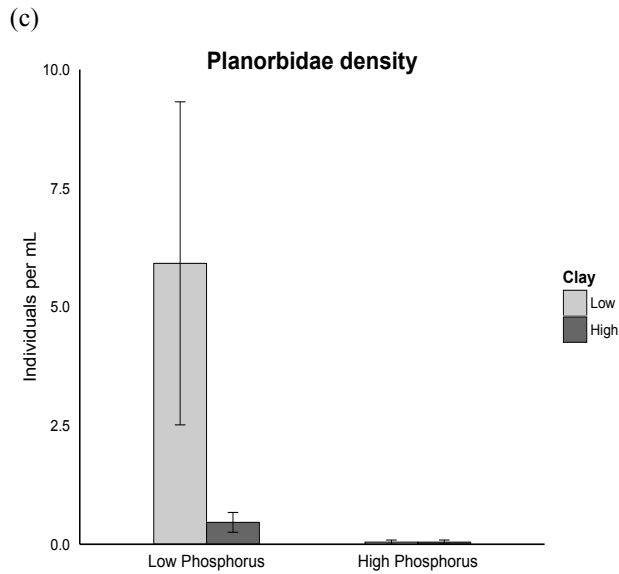
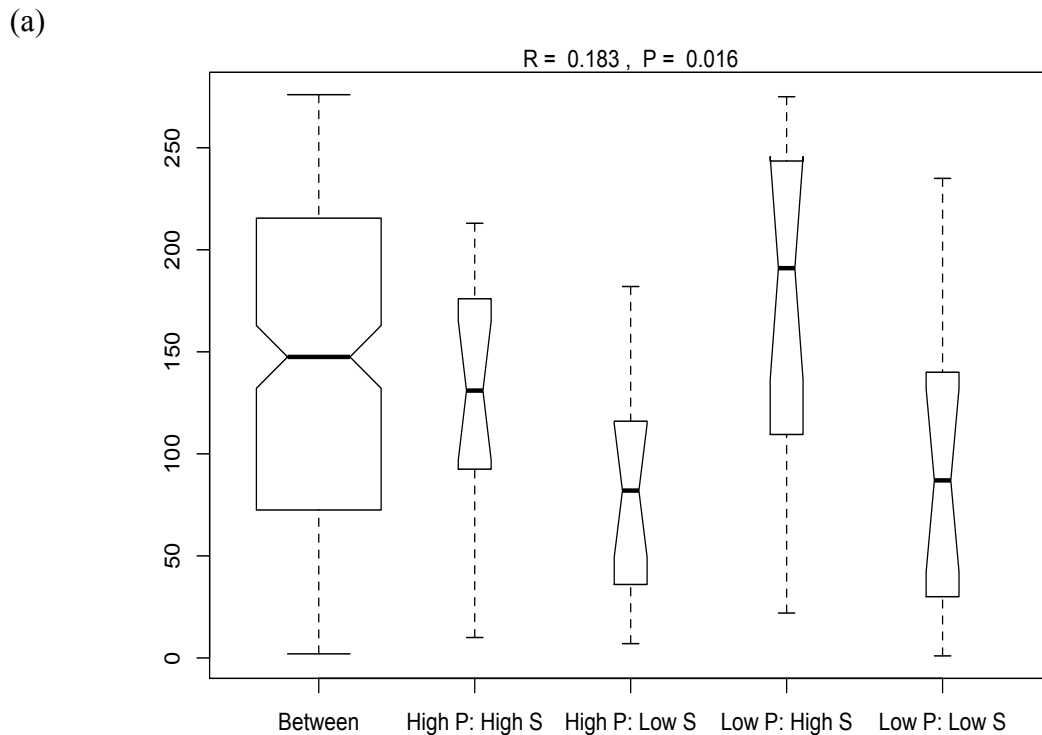

Fig. 8 Average variations of (a) invertebrate diversity and (b) evenness; and (c) Planorbidae density in response to combined clay and phosphorus treatments (mean±SE).

invertebrate taxa. Oppositely, the overlap between the “high P high clay” treatment, and the low P combinations was less pronounced, whereas the one between the “high P low clay” treatment, and the “low P low clay” combination, was minimal. Thus, added P was the major factor separating effects of different treatments on the invertebrate community.



(b)

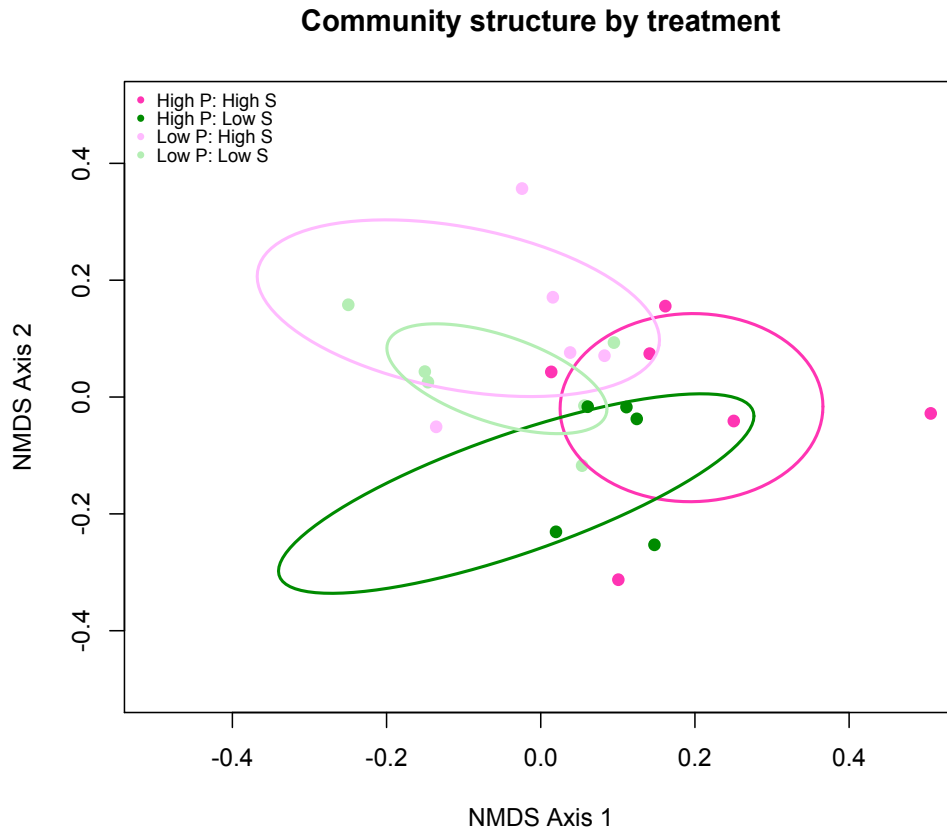

Fig. 9 (a) Boxplot of analysis of dissimilarity ranks (ANOSIM) between and within treatments for the invertebrate community. (b) Two-dimensional NMDS plot (stress score 0.144) of the invertebrate community structure. Circular symbols represent individual samples and ellipses indicate treatment (four combinations of phosphorus P and clay S) means with 95% confidence intervals fitted onto the spatial ordination.

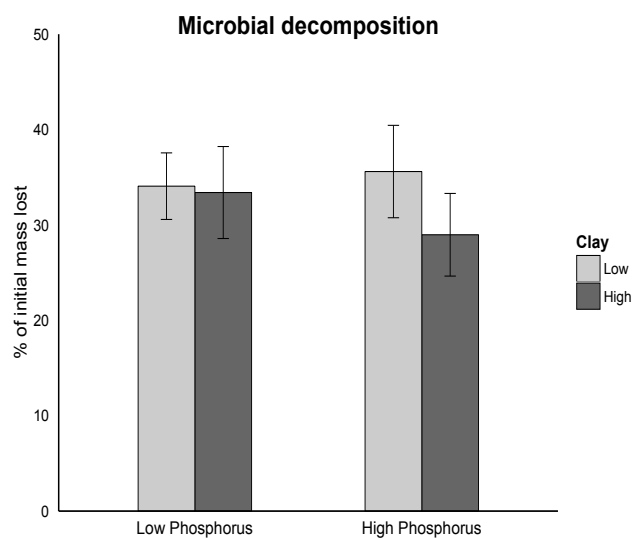

Fig. 10 Average variations of microbial decomposition in response to combined clay and phosphorus treatments (mean±SE).

3.4 Leaf litter degradation

Invertebrate leaf consumption increased with phosphorus enrichment (Table 3, appendix 9.3). Microbial decomposition was on the other hand, affected by a significant interaction between P and clay. Added P alone increased decomposition. However, this effect was weakened when combined with added clay (positive antagonistic P×clay interaction) (Table 3, Fig. 10).

4 Discussion

4.1 Physicochemical properties of water

High TSS and TP concentrations recorded in high clay and high P treatments, respectively, document a significant increase in the levels of stressors as a result of our manipulation. The achieved mean TP concentrations for high P treatments were moreover, relatively close to our target concentration of 150 µg P/L. In addition, generally lower TSS values recorded 24 h compared to 2 h after spiking, can be attributed to the successful sedimentation of clay in the flumes. Clay and P addition was furthermore not accompanied by changes in conductivity, salinity, dissolved oxygen, pH, temperature and current velocity. Thus, observed changes in algal and invertebrate communities, as well as leaf litter degradation, are most likely the result of the different combinations of clay and P concentrations rather than that of external factors.

4.2 Individual effects of sediment addition

Our results did not support hypothesis 1, as clay addition had a very limited direct effect on the biota. Added sediment impacted only 1 out of 32 algal genera, increasing the density of *Cosmarium*, a metaphytic algae. *Cosmarium* could have gained a competitive advantage over other algal growth forms that may have decreased in response to sediment addition (Piggott et al., 2012). Previous papers documented a decrease in adnate/prostrate and filamentous algae with added sediment, coupled by an increase in metaphytic forms (Piggott et al., 2015; Wagenhoff et al., 2013), while erect/stalked forms displayed mixed responses (Schneck et al., 2011). In this experiment, clay addition had no significant direct effect on algal biomass in general, nor any algal growth form in particular. However, adnate/prostrate forms were indeed least abundant in high clay treatments. Adnate or prostrate algae prefer colonizing smooth substrates (bare rocks). As such, addition of fine grained sediments to the habitat, could hinder colonization by these growth forms (Schneck et al., 2011).

Out of all the invertebrate taxa, sediment addition only affected oligochaetes, which decreased considerably in biomass with added clay. This trend opposes most published literature where sediment addition was recorded to positively impact the Oligochaeta taxon (Jones et al., 2012). Nevertheless, added sediment can negatively impact invertebrates through a variety of direct and indirect processes. These processes include clogging of interstitial spaces in the substrate and smothering of the river bed and bottom-dwelling fauna, as well as decreasing the amount of available habitat for invertebrates (Lenat, Penrose, & Eagleson, 1981; Wood & Armitage, 1997) and oxygen levels in the hyporheic zone (Gordon, McMahon, Finlayson, Gippel, & Nathan, 2004).

4.3 Individuals effects of phosphorus addition

As expected, phosphorus addition increased total algal biomass, including that of cyanobacteria and diatoms. Some of the most toxic cyanobacterial genera (*Anabaena*, *Microcystis*, and *Oscillatoria*) were also collected from tiles, with *Oscillatoria* density rising under high levels of P (Camargo & Alonso, 2006). The increase in diatom biomass could also have been accompanied by a rise in the relative abundance of toxic diatom genera. However, diatoms need to be identified to the genus level, for this to be confirmed. Filamentous algae, with the exception of *Teilingia*, also increased with nutrient enrichment while erect or stalked forms decreased, as documented by Passy (2007) and Wagenhoff et al. (2013). Filamentous forms have better access to light than erect or stalked forms and outcompete them at nutrient uptake. As filamentous algae grow, erect or stalked algae are consequently subjected to nutrient depletion and shading. This promotes a shift of dominance in the algal community from erect or stalked forms to filamentous forms (Passy, 2007). At the taxon level, *Cosmarium*, *Pediastrum* and *Staurastrum* decreased with P augmentation. *Cosmarium* and *Staurastrum* are used as bioindicators of oligotrophic conditions in rivers in Norway and would therefore decline under eutrophic conditions, with increased nutrient levels (Schneider & Lindstrøm, 2011). On the other hand, the decline in *Pediastrum* density opposes a documented trend of increasing metaphyton forms under nutrient enrichment (D'Aiuto, Makarewicz, & Bosch, 2006; Makarewicz, D'Aiuto, & Bosch, 2007). Competition against filamentous forms over light and nutrient, may be the limiting factor that prevented this metaphytic algae from thriving (D'Aiuto et al., 2006).

In partial disagreement with hypothesis 2, added P was detrimental to invertebrate biomass and density. P enrichment is a well-documented major stressor in freshwater

ecosystems and an important contributor to eutrophication (Justus, Petersen, Femmer, Davis, & Wallace, 2010; Struijs et al., 2011). Some of the effects of eutrophication include the proliferation of toxic algae, particularly toxin-producing cyanobacteria and diatoms (Camargo & Alonso, 2006; Carpenter et al., 1998), which can be observed in our sample. Grazing on these toxic algae, can be the reason why the biomass and density of pollution-tolerant taxa (Chironomidae, Cladocera, Copepoda and Planorbidae), as well as total invertebrate density, decreased with augmented P. The decline in cladocerans and copepods would have in turn weakened predation pressure on ciliates. This, coupled with the increased biomass of algae, an important food source for ciliates, may have resulted in the observed increase in ciliate density with added P (Marchessault & Mazumder, 1997). Despite its negative effect on invertebrate taxa, nutrient enrichment was correlated with an increase in invertebrate taxon richness, in addition to community diversity and evenness. This can be due to dominant invertebrate taxa (Chironomidae and Cladocera) becoming rarer with P fertilization as their densities decreased, while Temnocephalida, one of the least common invertebrates, increased in density.

As expected, P addition also promoted leaf litter degradation, by increasing invertebrate consumption of leaves. The rate of leaf consumption by shredders largely depends on the nutritional quality and palatability of leaf litter (Smock, 1999). Since nutrient enrichment enhances the nutritional quality and palatability of decaying leaves in streams (Pearson & Connolly, 2000), shredders can therefore consume leaf litter at a higher rate with added P.

4.4 Stressors compared: sediment versus phosphorus

Foregoing work has found sediment augmentation to be a largely pervasive factor affecting stream biota (Elbrecht et al., 2016; Wagenhoff et al., 2011). In this experiment however, the majority of algal and invertebrate taxa and their corresponding community parameters were unaffected by sediment addition, leading us to reject hypothesis 1. Based on our findings, added clay directly influenced 2 out of the total 67 biological variables, which is 3% of these, while phosphorus fertilization influenced 25 variables, thus around 37% of all biological variables. NMDS plots also showed that added P was the major factor separating effects of different treatments, on both algal and invertebrate communities. Thus, P addition exerted a more pervasive effect than fine sediment addition on the flume biota.

The fauna and flora in the Solberg River are likely adapted to clay-rich conditions, which can explain why they were so little affected by fine sediment addition. Still, the river is P-rich,

thus also eutrophic (G. Larsen, 2001). Therefore, its biota is likely adapted to eutrophic conditions as well. Despite this fact, an additional supply of P largely impacted the stream biota, while an additional supply of clay did not.

4.5 Interactions between sediment and phosphorus addition

Our prediction (hypothesis 3) that fine sediment addition and nutrient enrichment would have a combined antagonistic effect on the biota, including the ecosystem process of leaf litter breakdown, was not well supported. Two-way interactions between P and clay were in fact very rare, as they affected only 4 response variables, that is 6% of total biological variables, in contrast with existing multiple-stressor research (Lange et al., 2014; Matthaei et al., 2010). Nevertheless, P and clay interactions, where they occurred, were antagonistic as expected. These were positive antagonistic (less positive than predicted additively) in two cases and negative antagonistic (less negative than predicted additively) in two other cases. Furthermore, three of the response variables responded to combined clay and P in an additive manner, without any interactions among stressors. As such, there were no synergistic interactions between sediment and nutrient. According to Vinebrooke et al. (2004), a synergistic interaction between two stressors decreases the physiological tolerance of species to one stressor, as a result of exposure to the other stressor. This was unlikely to happen, since high levels of clay and phosphorus generally exert contrasting effects on species (Townsend et al., 2008; Vinebrooke et al., 2004). This theory is further supported by the additive effect of P and clay on *Cosmarium* density, where opposite effects of both stressors cancelled out each other when these were combined.

Phosphorus counteracted a positive effect of fine sediment addition on the abundance of metaphyton. High clay concentrations acted as a subsidy to metaphyton forms, by increasing habitat heterogeneity (Yarnell, Mount, & Larsen, 2006). However, when combined with P, the positive effect of clay was weakened, probably due to increased competition between algal forms, as a result of nutrient enrichment. In fact, filamentous forms are resource-unlimited and can therefore outcompete other algae at high nutrient levels (Passy, 2007). Competition with filamentous forms under high levels of P also negatively affected *Pediastrum* density, outweighing the negative effects of increased sediment levels, such as scouring and increased turbidity (Ryan, 1991), when both were combined.

Another positive antagonistic response to combined clay and P was that of microbial decomposition. Microbial decomposition exhibited the same trend as leaf strength loss in

Piggott et al. (2012), where positive effects of nutrient enrichment were outweighed by negative effects with added sediment. Added sediment can reduce interstitial dissolved oxygen in leaf bags, thus decreasing microbial biomass, specifically that of fungal decomposers because of their high sensitivity to hypoxia (Bruder, Salis, McHugh, & Matthaei, 2015; Medeiros, Pascoal, & Graca, 2009). Adversely, the positive effects of P fertilization are likely due to two reasons.

First, P fertilization could have increased the nutrient supply for microorganisms and promoted their growth and activity, leading to the observed rise in decomposition rates (Niyogi, Simon, & Townsend, 2003; Suberkropp, Gulis, Rosemond, & Benstead, 2010). Second, chironomid larvae were observed inside the fine mesh bags, all throughout the sampling period. Unfortunately, the dimensions of the fine mesh were too large to prohibit this taxon from entering the bags and affecting our measurements of microbial decomposition, which could be overestimated. Thus, the increased microbial activity may be due to the decline in chironomids under high levels of P, which would have reduced competition between detritivorous chironomid larvae and microorganisms over resources (Barlocher, 1980; Mandaville, 2002). Such a bimodal response of decomposers to nutrient enrichment in streams, where fertilization stimulates microbial activity but suppresses that of invertebrates, has already been documented by Baldy et al. (2007) and Woodward et al. (2012).

Invertebrate diversity and evenness were affected by a negative antagonistic interaction between P and clay. Contrary to some studies that did not find any correlation between sedimentation and the aforementioned bio-indices (Buendia, Gibbins, Vericat, Batalla, & Douglas, 2013; S. Larsen, Pace, & Ormerod, 2011), added clay decreased diversity and evenness mainly in flumes without phosphorus enrichment. As such, P fertilization offset deleterious impacts induced by fine sediment addition, such as embeddedness and smothering; a decrease in suitable habitat; and oxygen depletion (Harrison, Norris, & Wilkinson, 2007; Wood & Armitage, 1997). The negative additive response of Planorbidae density, to clay and P together, could itself be the result of the forecited processes, combined with grazing on toxic algae that can proliferate with eutrophication (Carpenter et al., 1998).

4.6 Management implications

Our mesocosm experiment revealed direct and combined effects of nutrient and sediment addition, on primary producers and consumers in streams, while controlling main stressors.

However, the flumes used did not form an open system with the river to allow the natural migration of invertebrates (Piggott et al., 2012). Thus, the effects of stressors on invertebrate drift were not included in this study. Furthermore, the experiment was conducted only once, with only two replicas per treatment, for a relatively short-term (only 6 weeks), and at a small-scale. Also, water from the supply holes may have diluted concentrations of clay and phosphorus, weakening the impact of both stressors. As such, extrapolation of our results to field conditions should be done with care.

Our main finding was that nutrient enrichment was the most pervasive stressor compared to fine sediment addition, which rarely impacted the stream biota. P fertilization stimulated algal proliferation, as well as changes in the distributions and abundances of algal growth forms. Eutrophication, triggered by excessive P levels, promoted the increase of toxic algae. In turn, grazing on toxic algae reduced the abundance of pollution-tolerant invertebrates, to the general benefit of the invertebrate community (increased richness, diversity and evenness). Rates of leaf litter degradation, a functional indicator of ecosystem health, furthermore increased with nutrient enrichment. Increased rates of leaf litter degradation can mark a change in ecosystem functioning, through changes in invertebrate productivity (Wallace et al., 1997), nutrient dynamics such as nutrient retention and transformation (Mulholland & Webster, 2010), and other ecosystem functions.

The Solberg River is sediment-rich, with clay and silt as part of the stream bed and the river chronically receiving fine sediment loads from agricultural runoff. Hence, the stream biota likely tolerates high levels of fine sediment, which would explain why it was barely affected by added clay. Moreover, the river is P-rich and continuously subjected to large inputs of P from agricultural runoff. As such, the biota is likely adapted to eutrophic conditions as well. Nevertheless, an additional increase in P was shown to greatly affect the ecosystem, while an additional increase in fine sediments did not. Hence, added P exerted a significant separate effect on the benthic communities of the Solberg river.

As for interactions between nutrient enrichment and fine sediment addition, these rarely occurred in our study. Nevertheless, complex interactions among multiple stressors are common in streams impacted by agriculture (Townsend et al., 2008). Moreover, where interactions occurred, their effect size was of the same magnitude as that of main effects. Thus, it is not enough to look at single effects, when assessing the impact of agriculture on river ecosystem health and integrity, as all possible interactions among stressors need to be considered as well (Bruder et al., 2015).

Most importantly, we have shown that P from agricultural soil erosion, can severely impact rivers that already have high levels of P and fine sediment. Consequently, the effective control of runoff from agriculture into neighboring rivers and streams, is critical for preventing or minimizing pollution and mitigating ecosystem degradation in these catchments. To achieve this, both phosphorus and sediment discharge, need to be reduced simultaneously, as it is hardly possible to control one without the other.

Much work remains to be done, for the consequences of agricultural land use in rivers to be fully understood. Stressors other than nutrient enrichment and fine sediment addition, can be associated with agricultural practices, such as water abstraction for irrigation (Magierowski et al., 2015) and pesticide leaching (Magbanua et al., 2013). Additional anthropogenic disturbances, such as climate change and cutting of riparian vegetation, can also severely impair water quality in rivers (Dosskey et al., 2010; Whitehead, Wilby, Battarbee, Kernan, & Wade, 2009). Thus, future research needs to investigate effects of the aforementioned stressors, together with the stressors we addressed, in order to develop proper guidelines for an integrated approach to river basin management.

5 Literature cited

- Allan, J. D., & Castillo, M. M. (2007). *Stream ecology: Structure and function of running waters* (2nd ed.). Dordrecht, the Netherlands: Springer.
- Babiyak, M. A. (2004). What you see may not be what you get: A brief, nontechnical introduction to overfitting in regression-type models. *Psychosomatic Medicine*, *66*, 411-421.
- Bakken, S. E., & Gillebo, F. (2011). *Frogn kommune: Hovedplan avløp og vannmiljø: 2012-2020* [Frogn municipality: Overall plan drainage and water environment: 2012-2020]. Retrieved from <https://www.frogn.kommune.no/contentassets/0f792775bd5041738413871915eee199/hovedplan---avlop-og-vannmiljo-2012-2020.pdf>
- Baldy, V., Gobert, V., Guérol, F., Chauvet, E., Lambrigt, D., & Charcosset, J.-Y. (2007). Leaf litter breakdown budgets in streams of various trophic status: effects of dissolved inorganic nutrients on microorganisms and invertebrates. *Freshwater Biology*, *5*(7), 1322-1335. doi:10.1111/j.1365-2427.2007.01768.x
- Barlocher, F. (1980). Leaf-eating invertebrates as competitors of aquatic hyphomycetes. *Oecologia*, *47*(3), 303-306.
- Begon, M., Townsend, C. R., & Harper, J. L. (2006). *Ecology: From individuals to ecosystems* (4th ed.). Oxford, UK: Blackwell Publishing.
- Berge, G., Nordal, I., & Hestmark, G. (1998). The effect of breeding systems and pollination vectors on the genetic variation of small plant populations within an agricultural landscape. *OIKOS*, *81*(1), 17-29.
- Bowes, M. J., Gozzard, E., Johnson, A. C., Scarlett, P. M., Roberts, C., Read, D. S., . . . Wickham, H. D. (2012). Spatial and temporal changes in chlorophyll-a concentrations in the River Thames basin, UK: Are phosphorus concentrations beginning to limit phytoplankton biomass? *Science of the Total Environment*, *426*, 45-55. doi:10.1016/j.scitotenv.2012.02.056
- Bray, J. R., & Curtis, J. T. (1957). An ordination of the upland forest communities of southern Wisconsin. *Ecological Monographs*, *27*(4), 325-349.
- Bruder, A., Salis, R. K., McHugh, N. J., & Matthaei, C. D. (2015). Multiple-stressor effects on leaf litter decomposition and fungal decomposers in agricultural streams contrast between litter species. *Functional Ecology*, *30*(7), 1257-1266. doi:10.1111/1365-2435.12598
- Buendia, C., Gibbins, C. N., Vericat, D., Batalla, R. J., & Douglas, A. (2013). Detecting the structural and functional impacts of fine sediment on stream invertebrates. *Ecological Indicators*, *25*, 184-196.
- Camargo, J. A., & Alonso, A. (2006). Ecological and toxicological effects of inorganic nitrogen pollution in aquatic ecosystems: A global assessment. *Environment International*, *32*(6), 831-849. doi:10.1016/j.envint.2006.05.002
- Carpenter, S. R., Caraco, N. F., Correll, D. L., Howarth, R. W., Sharpley, A. N., & Smith, V. H. (1998). Nonpoint pollution of surface waters with phosphorus and nitrogen. *Ecological Applications*, *8*(3), 559-568.
- Clarke, K. R., & Warwick, R. M. (2001). *Change in marine communities: An approach to statistical analysis and interpretation*, 2nd edition (2nd ed.). Plymouth, UK: PRIMER-E.
- D'Aiuto, P. E., Makarewicz, J. C., & Bosch, I. (2006). The impact of stream nutrient loading on macrophytes and metaphyton in Conesus Lake, USA. *Verh. Internat. Verein. Limnol.*, *29*(3), 1373-1376.

- Dosskey, M. G., Vidon, P., Gurwick, N. P., Allan, C. J., Duval, T. P., & Lowrance, R. (2010). The role of riparian vegetation in protecting and improving chemical water quality in streams. *Journal of the American Water Resources Association (JAWRA)*, 46(2), 261–277. doi:10.1111/j.1752-1688.2010.00419.x
- Drolc, A., & Koncan, J. Z. (2002). Estimation of sources of total phosphorus in a river basin and assessment of alternatives for river pollution reduction. *Environment International*, 28, 393-400.
- Elbrecht, V., Beermann, A. J., Goessler, G., Neumann, J., Tollrian, R., Wagner, R. D., . . . Leese, F. (2016). Multiple-stressor effects on stream invertebrates: A mesocosm experiment manipulating nutrients, fine sediment and flow velocity. *Freshwater Biology*. doi:10.1111/fwb.12713
- Eriksen, T. E., Lindholm, M., Røst, M. K., Solheim, A. L., & Friberg, N. (2015). *Vurdering av kunnskapsgrunnlag for leirpåvirkede elver* [Assessment of the knowledge base of clay-influenced rivers] (6792-2015). Retrieved from http://www.huvo.no/filer/dokumenter/rappporter/eksterne/annet/NIVA_6792-2015_Vurdering_av_kunnskapsgrunnlag_i_leirpvirkede_elver.pdf
- Fritz, C. O., Morris, P. E., & Richler, J. J. (2012). Effect size estimates: Current use, calculations, and interpretation. *Journal of Experimental Psychology: General*, 141(1), 2-18. doi:10.1037/a0024338
- Garcia, L. V. (2004). Escaping the Bonferroni iron claw in ecological studies. *OIKOS*, 105(3), 657-663.
- Gordon, N. D., McMahon, T. A., Finlayson, B. L., Gippel, C. J., & Nathan, R. J. (2004). *Stream hydrology: An introduction for ecologists* (2nd ed.). Chichester, UK: John Wiley & Sons.
- Grobbelaar, J. U., & House, W. A. (1995). Phosphorus as a limiting resource in inland waters; Interactions with nitrogen In H. Tiessen (Ed.), *Phosphorus in the global environment: Transfers, cycles and management* (Vol. 54, pp. 462): John Wiley & Sons.
- Haande, S., & Rohrlack, T. (2005). *Akersvatnet: Overvåking av vannkvalitet og toksinproduserende cyanobakterier i 2004* [Aker lake: Water quality monitoring and toxin cyanobacteria in 2004] (5016-2005). Retrieved from [http://rapp.niva.no/symfoni/RappArkiv4.nsf/URL/C125730900460902C1257015002209F1/\\$FILE/5016_200dpi.pdf](http://rapp.niva.no/symfoni/RappArkiv4.nsf/URL/C125730900460902C1257015002209F1/$FILE/5016_200dpi.pdf)
- Harrison, E. T., Norris, R. H., & Wilkinson, S. N. (2007). *The impact of fine sediment accumulation on benthic macroinvertebrates: Implications for river management*. Paper presented at the Proceedings of the 5th Australian Stream Management Conference. *Australian rivers: making a difference*, Charles Sturt University, Thurgoona, New South Wales, Australia.
- Hill, T., & Lewicki, P. (2006). *Statistics: Methods and applications: A comprehensive reference for science, industry, and data mining* (1st ed.). Tulsa, OK: StatSoft.
- Jarvie, H. P., Neal, C., & Withers, P. J. A. (2006). Sewage-effluent phosphorus: A greater risk to river eutrophication than agricultural phosphorus? *Science of the Total Environment*, 360, 246-253. doi:10.1016/j.scitotenv.2005.08.038
- Jones, J. I., Murphy, J. F., Collins, A. L., Sear, D. A., Naden, P. S., & Armitage, P. D. (2012). The impact of fine sediment on macro-invertebrates. *River Res. Applic.*, 28, 1055-1071. doi:10.1002/rra.1516
- Justus, B. G., Petersen, J. C., Femmer, S. R., Davis, J. V., & Wallace, J. E. (2010). A comparison of algal, macroinvertebrate, and fish assemblage indices for assessing low-level nutrient enrichment in wadeable Ozark streams. *Ecological Indicators*, 10(3), 627-638. doi:10.1016/j.ecolind.2009.10.007

- Lange, K., Townsend, C. R., & Matthaei, C. D. (2014). Can biological traits of stream invertebrates help disentangle the effects of multiple stressors in an agricultural catchment? *Freshwater Biology*, *59*, 2431-2446. doi:10.1111/fwb.12437
- Larsen, G. (2001). *Ås Kommune: Hovedplan for avløp og vannmiljø: 2001-2012* [Ås municipality: Master plan for drainage and water environment: 2001-2012]. Retrieved from <http://www.as.kommune.no/getfile.php/1113282.746.vqqdepsduc/Hovedplan+for+avl%C3%B8p+og+vannmilj%C3%B8.doc.as.pdf>.
- Larsen, S., Pace, G., & Ormerod, S. J. (2011). Experimental effects of sediment deposition on the structure and function of macroinvertebrate assemblages in temperate streams. *River Res. Applic.*, *27*, 257-267. doi:10.1002/rra.1361
- Legendre, P., & Legendre, L. (2012). *Numerical ecology* (3rd ed.). Amsterdam, Netherlands: Elsevier.
- Lenat, D. R., Penrose, D. L., & Eagleson, K. W. (1981). Variable effects of sediment addition on stream benthos. *Hydrobiologia*, *79*, 187-194.
- Lorenz, A. W., Korte, T., Sundermann, A., Januschke, K., & Haase, P. (2012). Macrophytes respond to reach-scale river restorations. *Journal of Applied Ecology*, *49*, 202-212. doi:10.1111/j.1365-2664.2011.02082.x
- Magbanua, F. S., Townsend, C. R., Hageman, K. J., Lange, K., Lear, G., Lewis, G. D., & Matthaei, C. D. (2013). Understanding the combined influence of fine sediment and glyphosate herbicide on stream periphyton communities. *Water Research*, *47*, 5110-5120.
- Magierowski, R. H., Read, S. M., Carter, S. J. B., Warfe, D. M., Cook, L. S., Lefroy, E. C., & Davies, P. E. (2015). Inferring landscape-scale land-use impacts on rivers using data from mesocosm experiments and artificial neural networks. *Plos One*, *10*(3). doi:10.1371/journal.pone.0120901
- Mainstone, C. P., & Parr, W. (2002). Phosphorus in rivers - ecology and management. *The Science of the Total Environment*, *282-283*, 25-47.
- Makarewicz, J. C., D'Aiuto, P. E., & Bosch, I. (2007). Elevated nutrient levels from agriculturally dominated watersheds stimulate metaphyton growth. *J. Great Lakes Res.*, *33*(2), 437-448. doi:[http://dx.doi.org/10.3394/0380-1330\(2007\)33\[437:ENLFAD\]2.0.CO;2](http://dx.doi.org/10.3394/0380-1330(2007)33[437:ENLFAD]2.0.CO;2)
- Mandaville, S. M. (2002). *Benthic macroinvertebrates in freshwaters-Taxa tolerance values, metrics, and protocols*. Retrieved from <http://citeseerx.ist.psu.edu/viewdoc/download?doi=10.1.1.516.2776&rep=rep1&type=pdf>
- Marchessault, P., & Mazumder, A. (1997). Grazer and nutrient impacts on epilimnetic ciliate communities. *Limnol. Oceanogr.*, *42*(5), 893-900.
- Matthaei, C. D., Piggott, J. J., & Townsend, C. R. (2010). Multiple stressors in agricultural streams: Interactions among sediment addition, nutrient enrichment and water abstraction. *Journal of Applied Ecology*, *47*, 639-649. doi:10.1111/j.1365-2664.2010.01809.x
- Matthaei, C. D., Weller, F., Kelly, D. W., & Townsend, C. R. (2006). Impacts of fine sediment addition to tussock, pasture, dairy and deer farming streams in New Zealand. *Freshwater Biology*, *51*, 2154-2172. doi:10.1111/j.1365-2427.2006.01643.x
- Medeiros, A. O., Pascoal, C., & Graca, M. A. S. (2009). Diversity and activity of aquatic fungi under low oxygen conditions. *Freshwater Biology*, *54*, 142-149. doi:10.1111/j.1365-2427.2008.02101.x

- Merriman, R. J., Highley, D. E., & Cameron, D. G. (2003). *Definition and characteristics of very-fine grained sedimentary rocks: clay, mudstone, shale and slate* (CR/03/281N). Retrieved from <https://www.bgs.ac.uk/downloads/start.cfm?id=1415>
- Metcalf, J. L. (1989). Biological water quality assessment of running waters based on macroinvertebrate communities: History and present status in Europe. *Environmental Pollution*, 60(1-2), 101-139. doi:10.1016/0269-7491(89)90223-6
- Mulholland, P. J., & Webster, J. R. (2010). Nutrient dynamics in streams and the role of J-NABS. *J. N. Am. Benthol. Soc.*, 29(1), 100-117. doi:10.1899/08-035.1
- Niyogi, D. K., Simon, K. S., & Townsend, C. R. (2003). Breakdown of tussock grass in streams along a gradient of agricultural development in New Zealand. *Freshwater Biology*, 48, 1698-1708.
- Passy, S. I. (2007). Diatom ecological guilds display distinct and predictable behavior along nutrient and disturbance gradients in running waters. *Aquatic Botany*, 86, 171-178. doi:10.1016/j.aquabot.2006.09.018
- Pearson, R. G., & Connolly, N. M. (2000). Nutrient enhancement, food quality and community dynamics in a tropical rainforest stream. *Freshwater Biology*, 43, 31-42.
- Peet, R. K. (1974). The measurement of species diversity. *Annual Review of Ecology and Systematics*, 5, 285-307.
- Perceval, O., Caquet, T., Lagadic, L., Bassères, A., Azam, D., Lacroix, G. r., & Poulsen, V. r. (2009). *Mesocosms: Their value as tools for managing the quality of aquatic environments*. Le Croisic, France.
- Perneger, T. V. (1998). What's wrong with Bonferroni adjustments. *British Medical Journal*, 316, 1236-1238.
- Piggott, J. J., Lange, K., Townsend, C. R., & Matthaei, C. D. (2012). Multiple stressors in agricultural streams: A mesocosm study of interactions among raised water temperature, sediment addition and nutrient enrichment. *Plos One*, 7(11). doi:10.1371/journal.pone.0049873
- Piggott, J. J., Salis, R. K., Lear, G., Townsend, C. R., & Matthaei, C. D. (2015). Climate warming and agricultural stressors interact to determine stream periphyton community composition. *Global Change Biology*, 21, 206-222. doi:10.1111/gcb.12661
- Prosser, I. P., Rutherford, I. D., Olley, J. M., Young, W. J., Wallbrink, P. J., & Moran, C. J. (2001). Large-scale patterns of erosion and sediment transport in river networks, with examples from Australia. *Marine and Freshwater Research*, 52, 81-99.
- PURA. (2011). *Årsrapport 2008-2010: PURA: Vannområdet Bunnefjorden med Årunge- og Gjersjøvassdraget* [Annual report 2008-2010: PURA: Water area Bunnefjorden with Årunge- and Gjersjøen watercourse]. Retrieved from <http://pura.no/publikasjoner/arsrapporter-for-overvakingen/>
- Quinn, G. P., & Keough, M. J. (2002). *Experimental design and data analysis for biologists*. Cambridge, UK: Cambridge University Press.
- Ryan, P. A. (1991). Environmental effects of sediment on New Zealand streams: A review. *New Zealand Journal of Marine and Freshwater Research*, 25(2), 207-221. doi:10.1080/00288330.1991.9516472
- Schneck, F., Schwarzbald, A., & Melo, A. S. (2011). Substrate roughness affects stream benthic algal diversity, assemblage composition, and nestedness. *J. N. Am. Benthol. Soc.*, 30(4), 1049-1056. doi:10.1899/11-044.1
- Schneider, S. C., & Lindstrøm, E.-A. (2011). The periphyton index of trophic status PIT: A new eutrophication metric based on non-diatomaceous benthic algae in Nordic rivers. *Hydrobiologia*, 665, 143-155. doi:10.1007/s10750-011-0614-7
- Serra, A., Guasch, H., Admiraal, W., Geest, H. G. V. d., & Beusekom, S. A. M. V. (2010). Influence of phosphorus on copper sensitivity of fluvial periphyton: The role of

- chemical, physiological and community-related factors. *Ecotoxicology*, *19*, 770-780. doi:10.1007/s10646-009-0454-7
- Shaw, G. R., Moore, D. P., & Garnett, C. (2003). Eutrophication and algal blooms. In A. Sabljic (Ed.), *Environmental and Ecological Chemistry* (Vol. 2, pp. 1-21). Oxford, UK: EOLSS Publishers.
- Slavik, K., Peterson, B. J., Deegan, L. A., Bowden, W. B., Hershey, A. E., & Hobbie, J. E. (2004). Long-term responses of the Kuparuk river ecosystem to phosphorus fertilization. *Ecology*, *85*(4), 939-954.
- Smock, L. A. (1999). Riverine floodplain forests of the Southeastern United States: Invertebrates in an aquatic-terrestrial ecotone. In D. P. Batzer, R. B. Rader, & S. A. Wissinger (Eds.), *Invertebrates in freshwater wetlands of North America: Ecology and management*. New York: John Wiley & Sons.
- Snekkerbakken, A. M., Ragnhildstveit, J., & Nordahl-Olsen, T. (2002). *Grunnvann i Frogn kommune* [Groundwater in Frogn municipality] (92.085). Retrieved from http://www.ngu.no/FileArchive/224/92_085.pdf
- Struijs, J., Zwart, D. D., Posthuma, L., Leuven, R. S. E. W., & Huijbregts, M. A. J. (2011). Field sensitivity distribution of macroinvertebrates for phosphorus in inland waters. *Integr. Environ. Assess. Manag.*, *7*, 280-286. doi:10.1002/ieam.141
- Suberkropp, K., Gulis, V., Rosemond, A. D., & Benstead, J. P. (2010). Ecosystem and physiological scales of microbial responses to nutrients in a detritus-based stream: Results of a 5-year continuous enrichment. *Limnol. Oceanogr.*, *55*(1), 149-160.
- Townsend, C. R., Uhlmann, S. S., & Matthaei, C. D. (2008). Individual and combined responses of stream ecosystems to multiple stressors. *Journal of Applied Ecology*, *45*, 1810-1819. doi:10.1111/j.1365-2664.2008.01548.x
- Tucker, M. R. (1999). *Clay minerals: Their importance and function in soils*. Retrieved from <http://www.ncagr.gov/agronomi/pdf/files/sfn13.pdf>.
- Vaselli, S., Bertocci, I., Maggi, E., & Benedetti-Cecchi, L. (2008). Effects of mean intensity and temporal variance of sediment scouring events on assemblages of rocky shores. *Mar Ecol Prog Ser*, *364*, 57-66. doi:10.3354/meps07469
- Vinebrooke, R. D., Cottingham, K. L., Norberg, J., Scheffer, M., Dodson, S. I., Maberly, S. C., & Sommer, U. (2004). Impacts of multiple stressors on biodiversity and ecosystem functioning: The role of species co-tolerance. *OIKOS*, *104*, 451-457.
- Wagenhoff, A., Lange, K., Townsend, C. R., & Matthaei, C. D. (2013). Patterns of benthic algae and cyanobacteria along twin-stressor gradients of nutrients and fine sediment: a stream mesocosm experiment. *Freshwater Biology*, *58*, 1849-1863. doi:10.1111/fwb.12174
- Wagenhoff, A., Townsend, C. R., & Matthaei, C. D. (2012). Macroinvertebrate responses along broad stressor gradients of deposited fine sediment and dissolved nutrients: A stream mesocosm experiment. *Journal of Applied Ecology*, *49*, 892-902. doi:10.1111/j.1365-2664.2012.02162.x
- Wagenhoff, A., Townsend, C. R., Philips, N., & Matthaei, C. D. (2011). Subsidy-stress and multiple-stressor effects along gradients of deposited fine sediment and dissolved nutrients in a regional set of streams and rivers. *Freshwater Biology*, *56*, 1916-1936. doi:10.1111/j.1365-2427.2011.02619.x
- Wallace, J. B., Eggert, S. L., Meyer, J. L., & Webster, J. R. (1997). Multiple trophic levels of a forest stream linked to terrestrial litter inputs. *Science*, *277*, 102-104.
- Webster, J. R., & Benfield, E. F. (1986). Vascular plant breakdown in freshwater ecosystems. *Annual Review of Ecology and Systematics*, *17*, 567-594.
- Welham, S. J., Gezan, S. A., Clark, S. J., & Mead, A. (2014). *Statistical methods in biology: Design and analysis of experiments and regression*. Boca Raton: CRC Press.

- Whitehead, P. G., Wilby, R. L., Battarbee, R. W., Kernan, M., & Wade, A. J. (2009). A review of the potential impacts of climate change on surface water quality. *Hydrological Sciences Journal*, 54(1), 101-123. doi:10.1623/hysj.54.1.101
- Wood, P. J., & Armitage, P. D. (1997). Biological effects of fine sediment in the lotic environment. *Environmental Management*, 21, 203-217.
- Woodward, G., Gessner, M. O., Giller, P. S., Gulis, V., Hladyz, S., Lecerf, A., . . . Chauvet, E. (2012). Continental-scale effects of nutrient pollution on stream ecosystem functioning. *Science Magazine*, 336, 1438-1440. doi:10.1126/science.1219534
- Yamada, H., & Nakamura, F. (2002). Effect of fine sediment deposition and channel works on periphyton biomass in the Makomanai River, Northern Japan. *River Res. Applic.*, 18, 481-493. doi:10.1002/rra.688
- Yarnell, S. M., Mount, J. F., & Larsen, E. W. (2006). The influence of relative sediment supply on riverine habitat heterogeneity. *Geomorphology*, 80, 310-324. doi:10.1016/j.geomorph.2006.03.005
- Yazdian, H., Jaafarzadeh, N., & Zahraie, B. (2014). Relationship between benthic macroinvertebrate bio-indices and physicochemical parameters of water: A tool for water resources managers. *Journal of Environmental Health Sciences & Engineering*, 12(30). doi:10.1186/2052-336X-12-30
- Young, R. G., Matthaei, C. D., & Townsend, C. R. (2008). Organic matter breakdown and ecosystem metabolism: Functional indicators for assessing river ecosystem health. *J. N. Am. Benthol. Soc.*, 27(3), 605-625. doi:<http://dx.doi.org/10.1899/07-121.1>
- Yuan, L. L., & Norton, S. B. (2004). Assessing the relative severity of stressors at a watershed scale. *Environmental Monitoring and Assessment*, 98, 323-349. doi:10.1023/B:EMAS.0000038194.30236.ad

Appendix 1

Appendix 1.1 The tank at the station was continuously filled with water from a point source in the Solberg River. This tank supplied the flumes with stream water through a single PVC pipe.



Appendix 1.2 One drum was set up at the outlet of each flume. The PVC pipe connected to the source tank ran through all the drums.



Appendix 1.3 At the level of each drum, a single hole was pierced through the pipe. This supply hole compensated for small leakages across flumes. An automatic pump was also fixed inside each drum. The pump's blue external float switch can be seen here.



Appendix 1.4 The flumes were designed to have a high gradient at the inlet level and a lower gradient at the outlet level (steel support posts at the inlet were 5 cm higher than those at the outlet). Thus, gravity powered the flow down from inlet to outlet where water ended up in the drum. Water was then pumped back to the inlet. The PVC pipe connecting the pump to the flume inlet is shown here.



Appendix 2

Schematic description of the design and dimensions of weirs inserted at the flume inlet and outlet.

Closed flume inlet

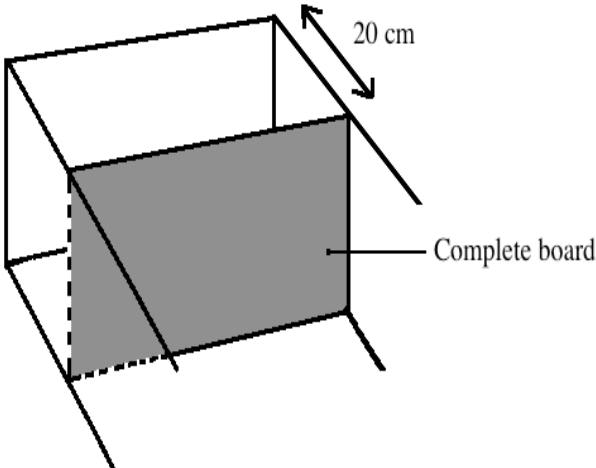

Open flume outlet

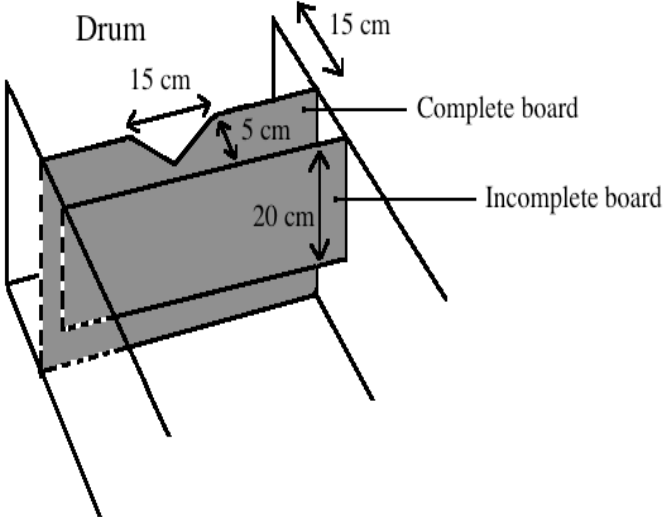

Appendix 3

The invertebrate sampling station was upstream the Solberg River, at a distance of 0.6 km from Ramme gård, Vestby. The location of the sampling station is indicated by a black cross in the map below. The surrounding forest was rich in deciduous and coniferous trees. The stream substrate was dominated by silt, clay and rocks. The surber sampler used can be clearly observed in the third picture.



Appendix 3 (continued)



Appendix 4

Norwegian blue clay was homogenized by mixing well with an Eibenstock mixing drill.



Appendix 5

Results of calculations made prior to applying combined clay and phosphorus treatments to flumes.

| Flume/drum set | Average water depth in flume (m) | Flume capacity (L) | Drum capacity (L) | Total capacity (L) | Mass of clay added (g) | Mass of P needed (g) | Mass of $\text{HNa}_2\text{O}_4\text{P} \cdot 12\text{H}_2\text{O}$ added (g) |
|----------------|----------------------------------|--------------------|-------------------|--------------------|------------------------|----------------------|---|
| 1 | 0.18 | 900.03 | 146.67 | 1046.7 | 52.35 | 0 | 0 |
| 2 | 0.17 | 850 | 149 | 999 | 5 | 0.15 | 1.73 |
| 3 | 0.18 | 900 | 149 | 1049 | 52.45 | 0 | 0 |
| 4 | 0.18 | 900 | 142 | 1042 | 5.21 | 0.16 | 1.85 |
| 5 | 0.21 | 1050 | 142 | 1192 | 59.6 | 0.18 | 2.08 |
| 6 | 0.2 | 1000 | 153.76 | 1153.76 | 5.77 | 0 | 0 |
| 7 | 0.2 | 1000 | 151.4 | 1151.4 | 5.76 | 0 | 0 |
| 8 | 0.2 | 1000 | 150.2 | 1150.2 | 57.51 | 0.17 | 1.96 |

Appendix 6

Appendix 6.1 Unglazed tiles used as substrate for algae.



Appendix 6.2 Fine and coarse mesh bags filled with alder leaves. Pierced holes in the coarse mesh bags are visible.



Appendix 7

Unidentified filamentous pseudo-branched cyanobacterium (F. P. Cyanobacterium) at the center of the microscope image (40× magnification).



Appendix 8

Stress plot for non-metric multidimensional scaling (NMDS) ordination of (a) the algal community; (b) algal growth forms; and (c) the invertebrate community.

(a)

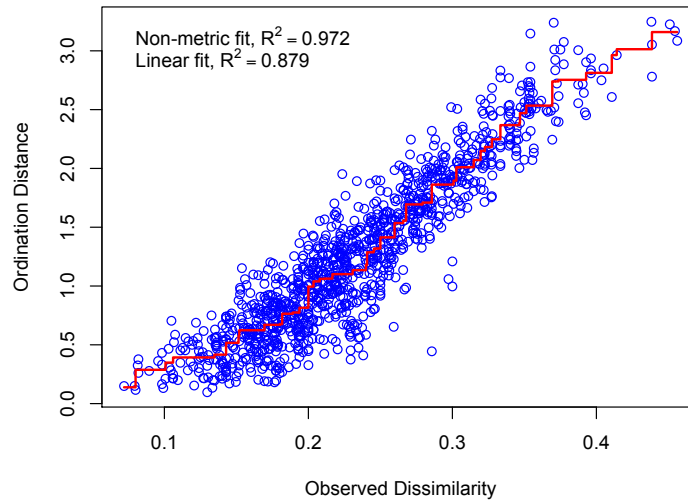

(b)

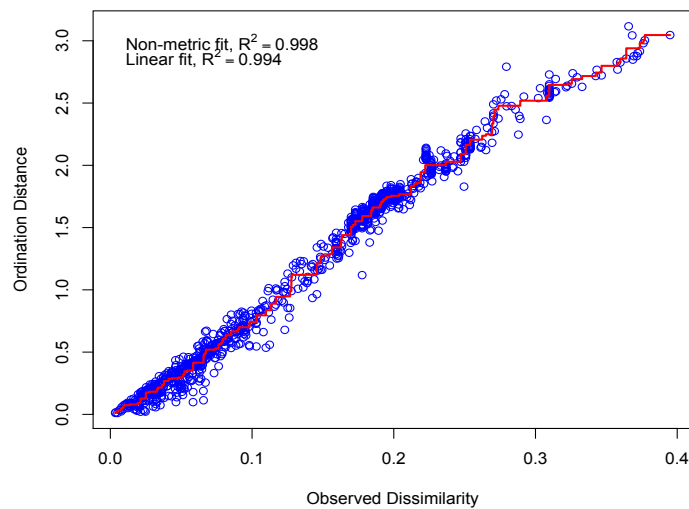

(c)

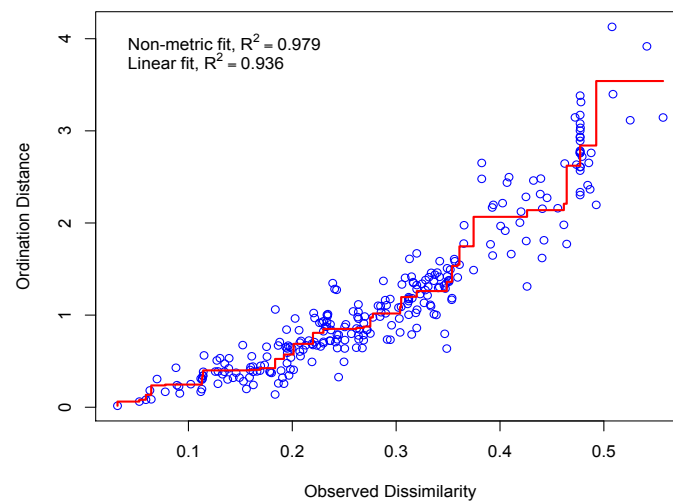

Appendix 9

Appendix 9.1 Average variations of algal response variables, as well as Ciliata density, in response to combined clay and phosphorus treatments (mean \pm SE).

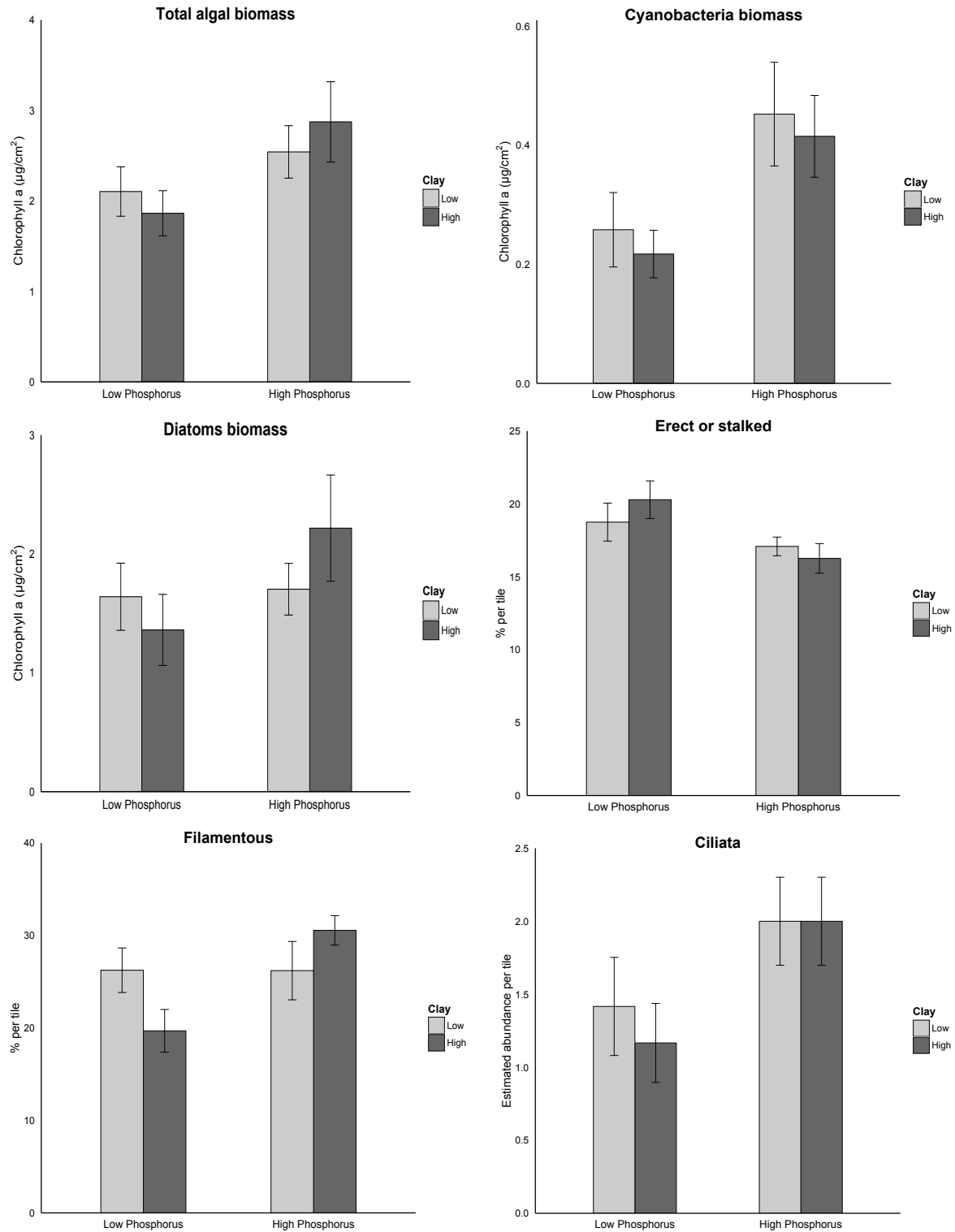

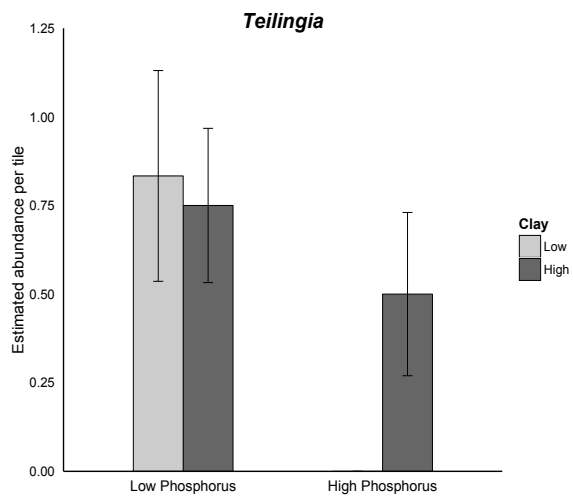
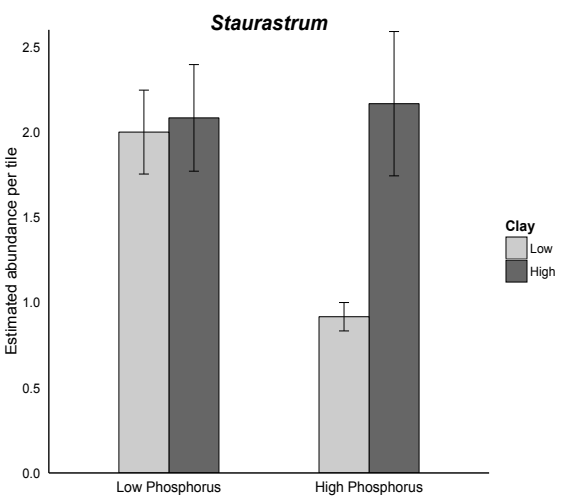
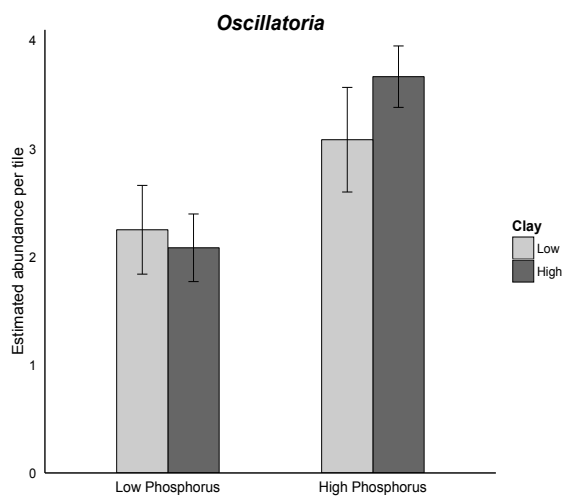
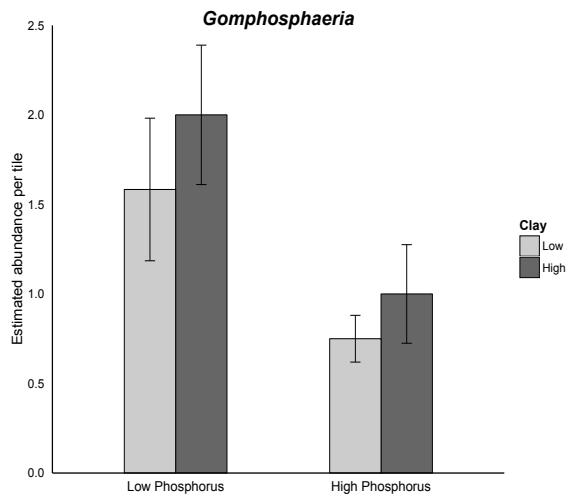
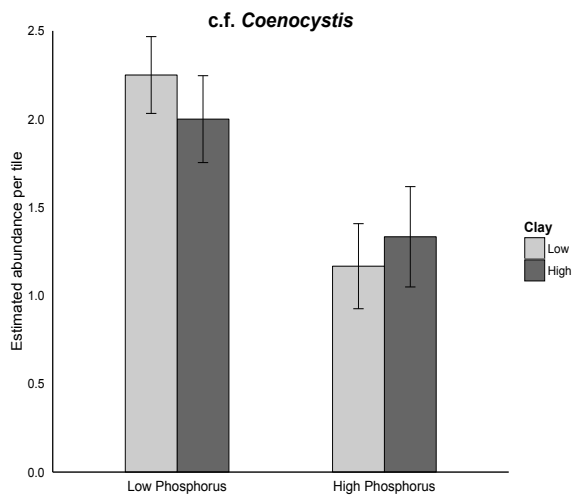

Appendix 9.2 Average variations of invertebrate response variables in response to combined clay and phosphorus treatments (mean \pm SE).

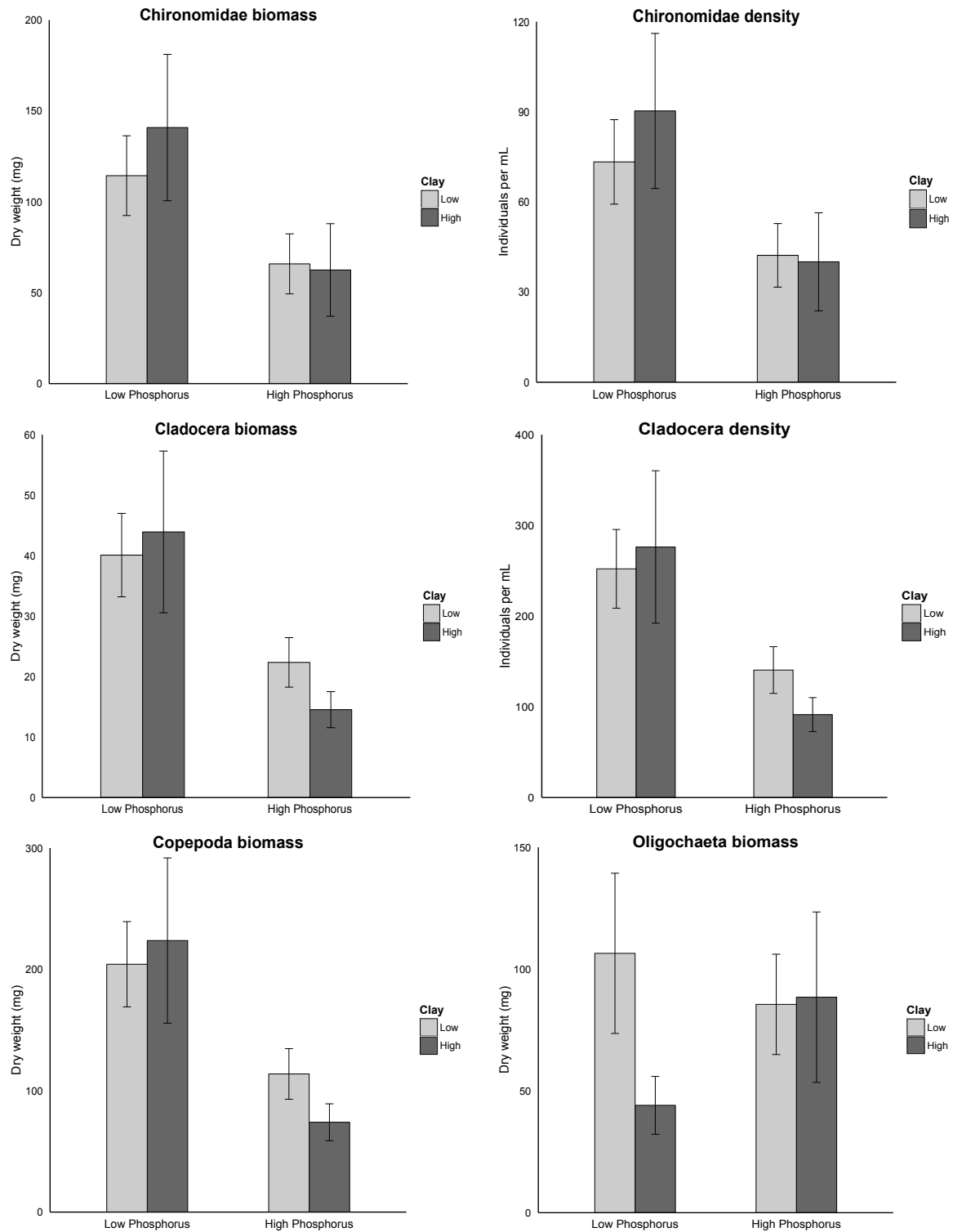

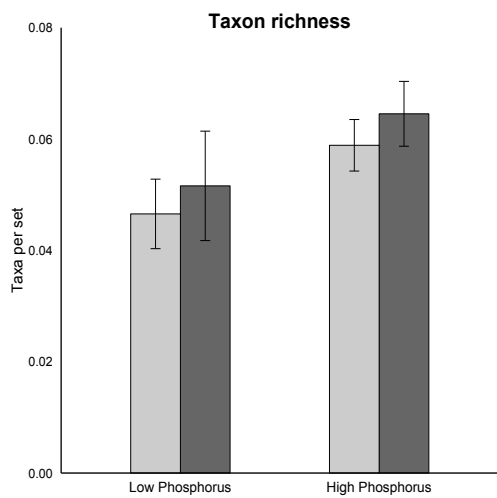
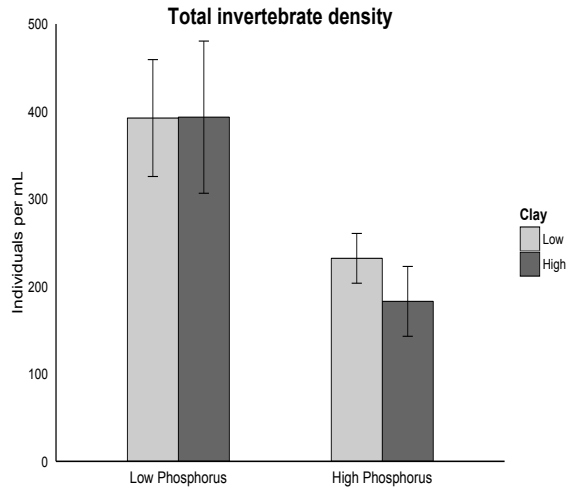
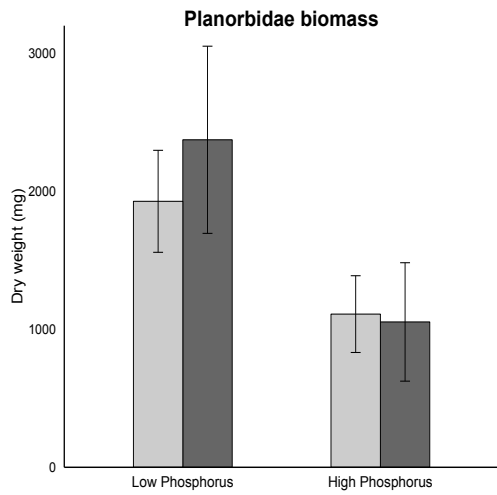

Appendix 9.3 Average variations of invertebrate consumption of leaf litter in response to combined clay and phosphorus treatments (mean \pm SE).

