



Norges miljø- og  
biovitenskapelige  
universitet

**Masteroppgave 2022 30 stp.**  
REALTEK

# **Electrochemical oxidation of per- and polyfluoroalkyl substances (PFAS) for wastewater treatment and UV-VIS quantification**

**Philip Lein**

Water and Environmental Technology



## ACKNOWLEDGEMENTS

Firstly, I would like to thank my supervisors Zakhar Maletskyi, Harsha Ratnaweera and Agnieszka Katarzyna Cuprys for inspiration and feedback for my thesis. The thesis is a part of the AECO-project which is in collaboration with the University of Calgary and Columbia University and I would like to thank everyone involved in the project and the study trip to UoC, where I was very well welcomed, and learned about the practicalities of electrochemical oxidation from both Dr. Edward Roberts and Dr. Nael Yasri of the UoC.

I would like to thank Lena Okسدøl Foseid, Fanjing Meng and Agnieszka Katarzyna Cuprys for help in the lab at NMBU, from simple things to more complex lab exercises.

Finally, I would like to thank my girlfriend, friends and family for help and support throughout the semester. To my good friend whom which I started at NMBU with, I would like to say "Hva skjer greit?".

Philip Lein

Ås, June 2022





## ABSTRACT

Proper wastewater treatment is vital to remove organic matter as well as persistent pollutants. That affects the biospheres that effluent is discharged to if not treated sufficiently, which has negative effects on the environment but also if the effluent is discharged to water bodies used as drinking water sources.

Electrochemical oxidation is a promising way to treat persistent pollutants effectively, degrading them to their most basic compounds. Experiments were done to find removal rates for per- and polyfluoroalkyl substances (PFAS), optimizing operational parameters and UV-VIS spectral measurements were done in conjunction with LC-MS measurements to see if there are any correlation between concentration of PFAS and UV-VIS absorbance.

Electrochemical oxidation was done with a BDD/stainless steel cell, with Flowrates ranging [159, 1841] mL/min, current densities ranging [32,39, 242,61] mA/cm<sup>2</sup>, and initial concentrations ranging [0,1009, 2,6002] ppm.

For parameters [Q; 0,5 L/min, CD: 200 mA/cm<sup>2</sup>, C: 0,629 ppm] achieved removal efficiencies of 67 % at 10 minutes, 84% at 15 minutes and a final removal rate of 99,88% at 90 minutes.



## ABSTRAKT

Tilstrekkelig avløpsrensing er viktig for å fjerne organisk materie og iherdige forurensninger. Slike forurensninger har en negativ effekt på biosfæren den slippes ut til hvis ikke renses tilstrekkelig. Det kan også ha negative konsekvenser for mennesker hvis det slippes ut til vannforekomster som brukes som drikkevannskilder.

Elektrokjemisk oksidering er en lovende prosess for både drikkevann- og avløpsvannrensing, og bryter forurensninger ned til deres grunnleggende forbindelser. Forsøk ble gjort for å finne rensesgrad for per- og polyfluoralkyl forbindelser (PFAS), optimalisere forsøksparametere og se om det er noen forbindelse mellom UV-VIS spektral målinger og LC-MS målinger.

Elektrokjemisk oksidering ble gjort med en BDD/rustfritt stål celle, med volumstrømmer mellom [159, 1841] mL/min, strømtettheter mellom [32,39, 242,61] mA/cm<sup>2</sup>, og initiale konsentrasjoner mellom [0,1009, 2,6002] ppm.

For parameterne [Q; 0,5 L/min, CD: 200 mA/cm<sup>2</sup>, C: 0,629 ppm] oppnådde rensesgrad på 67% ved 10 minutter, 84% ved 15 minutter og en endelig rensesgrad på 99,88% ved 90 minutter.



## TABLE OF CONTENTS

Acknowledgements.....	2
Abstract.....	4
Abstrakt.....	6
Figure list.....	11
Table list.....	13
List of abbreviations.....	15
1. Introduction.....	17
1.1. Background.....	17
1.2. Purpose.....	19
2. Organics in domestic wastewater: A review.....	20
2.1. Types of domestic wastewater.....	20
2.2. Organic matter in domestic wastewater.....	22
2.2.1. Typical organic constituents.....	22
2.2.2. Organic micropollutants, persistent organic contaminants and contaminants of emerging concern	23
2.2.3. PFAS.....	26
2.2.4. Quantification and characterisation methods.....	29
2.3. Treatment of organics in domestic wastewater.....	30
2.3.1. Methods: overview.....	30
2.3.2. Oxidation methods.....	31
2.3.3. Electrochemical methods.....	33
2.3.4. Electrochemical oxidation.....	34
2.4. Knowledge gap and research objectives.....	38
3. Material and methods.....	39
3.1. Systematic review.....	39
3.2. SFR case study.....	39
3.2.1. SEKRENS.....	39
3.2.2. Søndre Follo treatment plant.....	40
3.3. Bench scale testing.....	42
3.4. Design of experiments.....	44
3.4.1. Equipment.....	44
3.4.2. Materials.....	45
3.4.3. PFAS solution.....	45

3.4.4.	Response factors .....	46
3.4.5.	Electrooxidation .....	47
3.5.	Analytical techniques.....	50
4.	Results and discussion.....	52
4.1.	Concentrations and removal rates .....	52
4.2.	Preferred setup of parameters .....	53
4.3.	Removal rate per PFAS based on carbon chain length .....	55
4.4.	UV-VIS spectral measurements .....	57
4.5.	Foaming .....	61
4.6.	pH .....	61
4.7.	Sources of error .....	64
5.	Conclusion .....	66
	Literature .....	67
	Appendix 1. – Concentrations run 1-20(ng/L).....	70
	Appendix 2. – Experimental factors and logs .....	75
	Appendix 3. – Statistical analysis of UV-VIS and Residual concentrations.....	77
	Appendix 4. – Acquisition Method Report for LC-MS .....	102
	Appendix 5. – Peristaltic pump calibration .....	104
	Appendix 6. – Design Expert build report .....	105



## FIGURE LIST

Figure 1 – Structural formula PFOS (left) and PFOA (Folkehelseinstituttet, 2018) .....	26
Figure 2 – PFAS environmental pathways after leaving WWTPs (Hamid & Li, 2016). .....	28
Figure 3 – Direct and indirect electrochemical oxidation of organic compounds (Sillanpää & Shestakova, 2017) .....	35
Figure 4 – Scanning electron microscopy (SEM) of a BDD electrode after 2 hours of operation (Wu et al., 2011). .....	36
Figure 5 – Flowsheet of Søndre Follo treatment plant (Søndre Follo Renseanlegg IKS, 2017) .....	41
Figure 6 - Inside view of the ECO experimental unit, nearest nozzle is the inlet. ....	43
Figure 7 - Sideways view of the electrode stack, with a 2mm electrode gap. ....	43
Figure 8 – The setup in a fume hood.....	48
Figure 9 – Close up of the reservoir. ....	49
Figure 10 – Flowsheet of the setup.....	49
Figure 11 – a line graph showing the concentrations of the sum of PFAS for each run (1-20) over time. ....	52
Figure 12 – a line graph showing the removal efficiency of the sum of PFAS for each run (1-20) over time. ....	53
Figure 13 - A point diagram showing Residual PFAS concentration plotted against current density and showing correlation.....	54
Figure 14 - Two axis diagram, with a line graph for the sum of PFAS, and a stacked area diagram with a percentage distribution of the different PFAS compounds in the solution over time. ....	56
Figure 15 - grouped bar chart showing concentrations in ng/L of the different PFAS compounds and their change over time.....	56
Figure 16 – Normalised spectra with the baseline corrected for all the runs.....	58
Figure 17 – Correlation loadings for Sum of PFAS and wavelengths at 250 and 270 nm. ....	59
Figure 18 - UV254 plotted against Residual PFAS concentration.....	60
Figure 19 - UV254 plotted against current density. ....	60
Figure 20 – Foaming in the reservoir from heavy to light (left to right) .....	61
Figure 21 -pH measurements for runs with 75 mA/cm <sup>2</sup> . ....	62
Figure 22 - pH measurements for runs with 137,5 MA/CM <sup>2</sup> . ....	63
Figure 23 - pH measurements for runs with 200 MA/CM <sup>2</sup> . ....	63
Figure 24 - pH measurements over time for runs with CD outliers .....	64
Figure 25 - Theoretical- plotted against measured initial concentration.....	65





## TABLE LIST

Table 1 – Types of wastewaters .....	20
Table 2 – Typical organic constituents .....	22
Table 3 – Excerpt from <i>LIST OF PRIORITY SUBSTANCES IN THE FIELD OF WATER POLICY</i> (PRIORITY SUBSTANCES UNDER THE WATER FRAMEWORK DIRECTIVE, 2013) .....	24
Table 4 – Organic micropollutants, Persistent organic contaminants and contaminants of emerging concern ..	24
Table 5 – Quantification and characterisation methods.....	29
Table 6 – Conventional wastewater treatment processes.....	30
Table 7 – Removal rate of COD for different types of wastewater treatment plants, with mechanical/ pre-treatment (Ødegaard & Skråvseth, 1997).....	31
Table 8 - Oxidation methods .....	32
Table 9 – Electrochemical methods .....	33
Table 10 – Technical data for the electrochemical reactor from the manufacturer. ....	44
Table 11 – Constituents of the PFAS solution and their concentrations.....	45
Table 12 – Statistically randomised matrix using central composite design for response surface.....	46
Table 13 - Parameters for the statistically randomised matrix.....	47
Table 14 – A table showing the 4 runs with the best removal efficiencies at 15 minutes, displaying CD, theoretical- / measured initial concentration and their removal efficiencies.....	54
Table 15 - Removal rate from initial concentrations for each PFAS for different sampling times.....	57
Table 16 – Calibration of the peristaltic pump.....	104



## LIST OF ABBREVIATIONS

- AOP(s) Advanced oxidation process(es)
- BDD Boron-doped diamond (electrode)
- BFRs Brominated flame retardants
- BOD Biological oxygen demand
- CD Current density
- CECs Contaminants of emerging concern
- COD Chemical oxygen demand
- DC Direct current
- EC Electrocoagulation
- ECHA European Chemicals Agency
- ECO / EO Electrochemical oxidation
- EF Electroflotation
- EU European Union
- FOGs Fats, oils and greases
- HDPE High density polyethylene
- LC-MS Liquid chromatography mass spectrometry
- NEA Norwegian Environment Agency / Miljødirektoratet
- PAHs Polycyclic aromatic hydrocarbons
- PCPs Personal care products
- PE Person equivalents
- PFAS Per- and polyfluoroalkyl substances
- PP Polypropylene
- RPM Revolutions per minute
- SDG(s) Sustainable development goal(s)
- SEM Scanning electron microscopy
- SFR Søndre Follo WWTP
- t Time
- TOC Total organic carbon
- TS Total solids (sludge)
- UN United Nations
- UV-VIS Ultraviolet-visible spectrophotometry
- WFD Water Framework Directive
- WWTP(s) Wastewater treatment plant(s)



# 1. INTRODUCTION

## 1.1. BACKGROUND

The United Nations has gone through a long process of creating the *2030 Agenda for Sustainable Development*. The agenda is a course of action for a better world, with different metrics for achieving this. At its foundation, there are 17 sustainable development goals [SDGs], including Zero hunger (2) or Climate action (13). These were adopted in 2015 by all the UN member states. This gives the member states a blueprint to take on climate change and natural preservation while also improving human conditions like poverty and equality, and clean water alongside economic growth (United Nations, 2022b).

The 6<sup>th</sup> SDG states “*Ensure Availability and Sustainable Management of Water and Sanitation for all*” (United Nations, 2022a). It states that 3,6 billion people in 2020 still lack safely managed sanitation and 129 countries are not on their proper way to sustainably managed water resources by 2030 (United Nations, 2021). Although the SDGs weren’t adopted before 2015, the UN has had drinking water on its agenda with the *Community Water Supply* action plan since 1977 and sanitation from 1981 with the *International Drinking Water Supply and Sanitation Decade* (United Nations, 2022c). As it stands, the world is not on its way to reaching the goal in 2030 in sanitation. The sewage/-effluent is usually discharged to the nearest body of water, which has a negative influence on rivers, freshwater bodies, and wetlands. Further, it has an impact on their ecosystems as well as their ability to act as drinking water sources (Ødegaard, 2014). This ties in with SDG 14 *Conserve and sustainably use the oceans, seas and marine resources for sustainable development* where emissions cause the same problems in saltwater bodies. E.g. high nitrogen emission from wastewater can cause eutrophication, high organic matter emissions which can cause saprophytic conditions, where sewage discharge is one of the primary drivers, or priority pollutants that have ecotoxic effects (United Nations, 2021).

The EU Water Framework Directive [WFD] (*Directive 2000/60/EC of the European Parliament and of the Council establishing a framework for the Community action in the field of water policy*) was adopted on the 23. October 2000, then published and implemented the 22. December 2000 (European Commission, 2022a). The WFD is a broad view directive covering all water related issues within the European Union: drinking water, wastewater, inland and

marine water and proper water management regarding river basins, flood risk and water scarcity. The main goals scope is setting parameters, chemical and biological, for good water quality for both surface and ground water, reaching a “good” status within these parameters by 28. December 2015 (Water Framework Directive, 2000), proper water management based on river basins crossing European borders, limiting emission and fix legislation and pricing (European Commission, 2022b). Through the European Economic Area, Norway is bound to follow the WFD and implement it in Norwegian law (Endringslov til naturmangfoldloven, 2018).

In 2019 the Norwegian Environment Agency [NEA] sent a letter to the county governors instructing that practice must be improved regarding release of wastewater to sensitive and normal areas. The letter states that secondary treatment is put as a demand to be covered by the Pollution Control Regulations (*Forurensningsforskriften*) section 14 with a recommended deadline of 7 years to completion (Miljødirektoratet, 2019). The EU commission, followed by the NEA, defines the secondary treatment demand as a discharge limit of 25 mg/L or 70% removal of BOD and 125 mg/L or 75% removal of COD (Klima- og miljødepartementet, 2004, § 14).

It was argued that it was not socio-economical for the treatment plants to expand with a biological step before a major upgrade was due. As it is the inhabitants that pay for both maintenance and upgrades of the WWTPs through fees. This problem has been persisting for far too long, thus many treatment plants still do not meet the requirements for secondary treatment. (Miljødirektoratet, 2019). For this reason, several mechanical-chemical treatment plants have received a demand to put in place secondary treatment by 2025 (SEKRENS). The NEA alerts that the goal is to be widened, so all discharges to sensitive and normal areas are following the secondary treatment demand. The priority is set to areas in catchments to sensitive areas and vulnerable freshwater recipients in normal areas. In practice, this means many Norwegian wastewater treatment plants will get a demand to uphold to the secondary treatment in short time (SEKRENS).

## 1.2. PURPOSE

As sewage and sewage effluent continues to be a problem worldwide to water bodies and their ecospheres, both the UN and EU have wastewater discharges and its effects on the environment on their agenda and implemented in their legislation (United Nations, 2022b; Water Framework Directive, 2000). Through the EEA, it is also implemented in Norwegian law. Despite implementation, the process has taken longer than expected and the NEA has taken action to force the WWTPs to meet requirements of secondary treatment (Miljødirektoratet, 2019).

The discharge of wastewater effluent does not only bring organic matter that consume oxygen or nutrients for algal blooms in the recipient. Since the sewers is the recipient of many sources of waste and wastewater, the outlet of a WWTP acts as a point source for micropollutants and contaminants of emerging concern that conventional wastewater treatment processes fail to remove effectively (Ødegaard, 2014). PFAS (Per- and polyfluoroalkyl substances) is one group of such contaminants, being persistent and bioaccumulating alongside its adverse health effects, a group among many manmade chemicals that is in need of sufficient removal (Garg et al., 2021). While some PFAS are regulated in use (ECHA, 2022), many are not and therefore, we need to explore ways to meet the requirements of secondary treatment and remove persistent contaminants like PFAS, and ways to do it without the need for a biological treatment step. There is also a need to be able to quantify PFAS quickly and affordably so that it is easier to monitor PFAS for WWTPs.



## 2. ORGANICS IN DOMESTIC WASTEWATER: A REVIEW

### 2.1. TYPES OF DOMESTIC WASTEWATER

Municipal wastewater is composed of many different types of wastewaters as can be seen in Table 1. The WWTPs receive wastewater from households, commercial and public buildings, and industrial wastewater for example, paper mills, food production. In cases where the wastewater grid is a combined sewerage system, runoff and stormwater also enter the pipelines (Ødegaard, 2014). No two cities are alike, in differences in local geology, where geography influences lengths of pipes and the rate infiltration water leaks into the pipes, they also differ in the number of people living in them and type of industry that discharges wastewater to the sewage system. This means one wastewater treatment plants strategy to treat wastewater may be vastly different to its neighbouring town/city due to their diverse wastewater composition (Ødegaard, 2014).

Wastewater is therefore commonly characterized by its physical properties as well as its chemical and biological properties. The properties of any given wastewater is also dependant on the source and its characteristics and what kind of treatment it has received before distribution (METCALF & EDDY & AECOM, 2014).

The journey of the wastewater from the producer to the WWTP also plays a part in the influent composition. Along the sewage system there are several physico-chemical phenomena that can take place. As the sewers are rarely pressurized, there is oxygen available for oxidation process to occur. If the velocity of the wastewater is insufficient or the wastewater flow meets a bump, it also causes a decrease in velocity solids in the wastewater may settle. To some degree, it is possible for the excreted bacteria or bacteria from grey water to begin the biological processes of breaking down organic matter (Thomas & Burgess, 2017).

TABLE 1 – TYPES OF WASTEWATERS

<b>Wastewater type</b>	<b>Description</b>
<b>Domestic wastewater</b>	<ul style="list-style-type: none"><li>• Wastewater, composed of soluble, colloidal and suspended constituents, produced by various human activity, such as households, office, public- and commercial buildings.</li></ul>

- Composed of black- and grey water, coming from toilets and other sources such as shower, dishwasher, kitchen, and other utilitarian appliances, respectively.
- Black water is the most nutritious fraction of wastewater. It constitutes around 69% of chemical oxygen demand [COD], 83% of nitrogen and 87% of phosphorus in wastewater. The range of COD is 250-300 mg O<sub>2</sub>/L from households (Toldt et al., 2015).
- Grey water is less nutritious and more diluted. It contains detergents, surfactants, kitchen waste.
- It is estimated that the average water usage per capita per day in Norway is 160 L, and 150 L is discharged as wastewater (Bomo & Schade, 2015).  
(Ødegaard, 2014)

**Industrial wastewater**

- Constituents and concentrations depend on the type of industry, size of operation, normal operation/clean-up procedures.
- A facility may be subject to treat their wastewater effluents before its release to the municipal sewage system by the municipality.
- (METCALF & EDDY & AECOM, 2014)

**Runoff / stormwater**

- Water from precipitation and snowmelts on the surface soil.
- In a combined sewage system, stormwater enters the sewage system through gutters and drains from streets, roofs, etc. May enter sewers as infiltration water through cracks and other openings.
- Composition depends on where is and what is around it, how long ago since the previous rainfall, the duration and intensity of rain and when it is measured. The first flush usually carries with it the highest number of contaminants from the ground/surface.  
(Ødegaard, 2014)

**Infiltration water**

- May either be rain/stormwater or groundwater.
- Infiltration water from stormwater is dependent on precipitation.
- Infiltration water from groundwater is mostly constant, but stormwater can also raise the groundwater table.

- The older the network, the more likely it is to have a higher infiltration rate, as pipes and joints are more likely to become pervious. (METCALF & EDDY & AECOM, 2014)

## 2.2. ORGANIC MATTER IN DOMESTIC WASTEWATER

### 2.2.1. TYPICAL ORGANIC CONSTITUENTS

“The organic composition of wastewater is approximately 50% proteins, 40% carbohydrates, 10% fats and oils, and trace amounts (e.g., µg/L or less) of priority pollutants, surfactants, and emerging contaminants” (Shon et al., 2006). Raw wastewater contains an average total organic carbon [TOC] of  $267 \pm 93$  mg C/L and COD of  $1164 \pm 157$  mg O<sub>2</sub>/L (Płuciennik-Koropczuk & Myszograj, 2019). Typical organic constituents are presented in Table 2.

One way to measure organic constituents is by testing for chemical oxygen demand or COD, which is a measurement of the consumption of an oxidizing agent and the conversion in an equivalent amount of oxygen in an acid solution. COD is given in g O<sub>2</sub>/m<sup>3</sup> or mg O<sub>2</sub>/L, which will be equivalent. The oxidizing agent is usually dichromate. COD can be fractionated into, soluble-, colloidal- and particulate COD. These can further be fractionated into readily-, slowly- and non-biodegradable (METCALF & EDDY & AECOM, 2014).

TABLE 2 – TYPICAL ORGANIC CONSTITUENTS

Organic constituent	Description
<b>Proteins</b>	<ul style="list-style-type: none"> <li>• Proteins contain carbon, hydrogen, and oxygen, and may be very complex.</li> <li>• After urea, proteins are the secondary sources for nitrogen in wastewater.</li> <li>• (Shon et al., 2006; Ødegaard, 2014)</li> </ul>
<b>Carbohydrates</b>	<ul style="list-style-type: none"> <li>• The carbohydrates found in wastewater include sugars, cellulose, starches, and wood fibre, where some are water-soluble and others not.</li> <li>• Cellulose from toilet paper is the main source of insoluble COD in wastewater (Chen et al., 2017), and may constitute up to 35% of</li> </ul>

suspended solids in influent to a WWTP. The addition of toilet paper (5 g/L) to wastewater may increase the COD content up to 12 times (Torfs et al., 2017).

<b>Fats, oils and greases (FOGs)</b>	<ul style="list-style-type: none"><li>• Primarily a by-product of cooking and food processing.</li><li>• Requires more time, energy, and resources to remove than more common organic constituents due to its molecular structure and hydrophobic properties.</li><li>• FOGs are less biologically degradable, solidify and cause issues to pumps, screens, filters etc.</li></ul> <p>(Enva, 2022)</p>
--------------------------------------	--

#### 2.2.2. ORGANIC MICROPOLLUTANTS, PERSISTENT ORGANIC CONTAMINANTS AND CONTAMINANTS OF EMERGING CONCERN

In addition to the typical organic constituents presented in Table 2, there is a large number of organic pollutants that enter WWTPs and are rarely removed by conventional treatment methods. Usually, these compounds are only present in trace amounts, e.g.,  $\mu\text{g/L}$  or less. Risks connected to these types of pollutants include but are not limited to bioaccumulation, toxicity, carcinogenicity, reproductive toxicity, endocrine disruption, etc. Examples of pollutants like this are surfactants, priority pollutants, and agricultural pesticides (Shon et al., 2006). The number of these increase as new organic molecules continues to be synthesized (Shon et al., 2006).

Under the *Water Framework Directive*, the European commission has a list of priority substances, that are to be monitored, and ultimately be phased out of discharges and emissions within 20 years. The list first adopted in 2001, has since been amended twice, last in 2013 and currently hosts 45 priority substances and 21 of them are considered priority hazardous substances (Priority substances under the Water Framework Directive, 2013), Table 3 shows an excerpt of 5 substances from the EUs list of priority substances.

TABLE 3 – EXCERPT FROM LIST OF PRIORITY SUBSTANCES IN THE FIELD OF WATER POLICY (PRIORITY SUBSTANCES UNDER THE WATER FRAMEWORK DIRECTIVE, 2013)

Number	CAS number	EU number	Name of priority substance	Identified as hazardous substance
(31)	12002-48-1	234-413-4	Trichlorobenzenes	
(32)	67-66-3	200-663-8	Trichloromethane (chloroform)	
(33)	1582-09-8	216-428-8	Trifluralin	X
(34)	115-32-2	204-082-0	Dicofol	X
(35)	1763-23-1	217-179-8	Perfluorooctane sulfonic acid and its derivatives (PFOS)	X

Some select groups of organic micropollutants and persistent organic contaminants is presented in Table 4.

TABLE 4 – ORGANIC MICROPOLLUTANTS, PERSISTANT ORGANIC CONTAMINANTS AND CONTAMINANTS OF EMERGING CONCERN

Pollutant/ contaminant group	Description
<b>Pesticides</b>	<ul style="list-style-type: none"> <li>• A substance containing one or more active substances intended to protect crops from unwanted plants, animals/insects, or fungi. An active substance is a chemical, plant extract, pheromone or micro-organism that deter unwanted plants and wildlife from where its applied.</li> <li>• May enter the sewage through runoff water or from industrial wastewater, especially food processing industry.</li> <li>• Maximum residue levels – is the highest amount of remnants of pesticide that is allowed on food or feed. This may be an issue if sludge containing pesticides is used for agricultural purposes.</li> <li>• May disrupt the ecosphere of the water body the WWTP discharges into.</li> <li>• (European Commision, 2022c; Ødegaard, 2014)</li> </ul>

**Pharmaceuticals  
/ Personal care  
products (PCPs)**

- Pharmaceuticals such as paracetamol, ibuprofen, trimethoprim, ciprofloxacin are regularly found in WWTPs.
- May enter through flushing of pharmaceuticals or PCPs, through excreta, washing away applied products or from hospitals.
- Pharmaceuticals can have effects as antibiotic resistance, endocrine disruption, toxicity, ecotoxicity, etc.  
(WHO, 2012; Ødegaard, 2014)

**Surfactants**

- Compounds usually found in detergents but may also be found in paint and varnish. Such as linear alkyl sulphonates, nonylphenols.
- Used for their hydrophilic and hydrophobic properties.
- These compounds may have endocrine disrupting properties, ecotoxic, bioaccumulation, carcinogenic
- (Ødegaard, 2014)

**Polycyclic  
aromatic  
hydrocarbons  
(PAHs)**

- A group of organic compounds is formed from incomplete combustion processes and exist in oil products.
- Examples of PAHs include naphthalene, benzo(a)pyrene, fluorene, anthracene etc.
- PAHs can be carcinogenic, ecotoxic, toxic and is especially toxic to waterborne life.  
(Blytt & Stang, 2018; Ødegaard, 2014)

**Brominated  
flame  
retardants  
(BFRs)**

- A group of compounds that contain bromine, and is used to decrease the flammability of products. Uses include plastics and textiles, thermal insulation, circuitry, and consumer appliances.
- BFRs are bio-accumulative, endocrine disrupting and toxic.
- WWTPs that receive wastewater from industries like laundries or textile industry receive higher than average concentrations of BFRs.  
(Blytt & Stang, 2018; Ødegaard, 2014)

**PFAS**

- Carbon-fluorine compounds with a wide range of uses.

- PFAS has surfactant properties, alongside their strong carbon-fluorine bonds make them toxic to their environments.  
(Blytt & Stang, 2018; Haug et al., 2018)

### 2.2.3. PFAS

Per- and polyfluoroalkyl substances (PFAS) are a group of carbon-fluorine containing synthetic compounds that are widely used due to their properties. Uses range from food packaging, fire-fighting foam, aviation, ski wax, and more. There are over 7000 PFAS, with little known health and environmental effects for many of them (Folkehelseinstituttet, 2018). The carbon-fluorine bond is one of the strongest bonds in organic chemistry. This gives PFAS good properties for all types of products and uses but is also the reason for bioaccumulation and accumulation in the environment (ECHA, 2022).

PFAS are divided into short- and long-chained compounds. “PFAS are defined as substances that contain at least one fully fluorinated methyl (CF<sub>3</sub>-) or methylene (-CF<sub>2</sub>-) carbon atom (without any H/Cl/Br/I atom attached to it)” (ECHA, 2021). Short-chain PFAS has < 6 carbon atoms and long-chain PFAS ≥ 6 carbon atoms. Each carbon atom is attached to two other carbon atoms and two fluorine atoms. The ends of the chains are either connected to another fluorine atom or a functional group, carboxylic acid, alcohol etc., the fluorinated carbon chain is hydrophobic while the functional group is hydrophilic (AWWA, 2019). Two long-chained PFAS with a carbon chain length of 8 are shown in Figure 1, PFOS and PFOA.

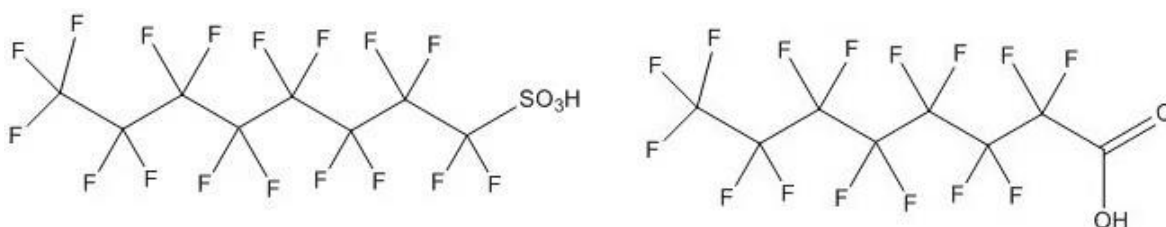

FIGURE 1 – STRUCTURAL FORMULA PFOS (LEFT) AND PFOA (FOLKEHELSEINSTITUTTET, 2018)

Five member states (Germany, Denmark, Netherlands, Norway, and Sweden) have stated an intent to propose a ban on PFAS to European Chemicals Agency [ECHA], due to environmental,

accumulative, and human health risks. They include reduced reproductivity ability, interference with foetus development, carcinogenicity, endocrine disruption (ECHA, 2021).

As seen in Table 3 PFOS and its derivatives is in EUs list of priority substances. The Norwegian list of priority substances includes six more in addition to PFOS and their derivatives, (PFOA, PFHxS, PFCA, PFBS, PFHxA, HFPO-DA) (Miljødirektoratet, 2022). The EU has recently added limit values in drinking water for PFAS, i.e., PFAS total and sum of PFAS. It is expected that the same limit values will be implemented in Norwegian legislation. The total amount of PFAS shall not exceed 500 ng/L, which will be applied when proper guidelines for monitoring are developed. The sum of PFAS is the sum of 20 PFAS that are of concern for human consumption, these shall not exceed 100 ng/L (Drinking Water Directive, 2020). This may limit the amount of PFAS coming from domestic wastewater to WWTPs.

A report on PFAS in drinking water in Norway, concludes that PFOS was measured in samples for all DWTPs tested for, 20 drinking water sources in total. 31 PFAS were tested for including the 20 PFAS that are of concern to human consumption in the Drinking Water Directive. Considering the limit values for PFAS in the Drinking Water Directive, the values are low at between 0-2 ng/L for raw water and about halved for the treated water. There was one outlier where the source is in proximity to a facility that has used fire-fighting foam containing PFAS extensively, where the raw and treated water had average concentrations of PFAS at ~6,5 ng/L and ~4,5 ng/L respectively (Grung et al., 2022). In Denmark, a limit value of 2 ng/L has been put on the sum of the 4 PFAS, in drinking water, that is included in the European Food Safety Authority risk assessment (PFOS, PFOA, PFNA and PFHxS) (Grung et al., 2022).

Another report on organic environmental pollutants in Norwegian wastewater sludge, concludes that PFAS was found in all 12 WWTPs that were tested. The average value of PFAS was 40 µg/kg TS of sludge (Total Solids). The two WWTPs with the highest concentrations of PFAS are in proximity of airports where fire-fighting foam containing PFAS has previously been in use, i.e. Gardermoen (118 µg/kg TS) and Fuglevik (101 µg/kg TS) (Blytt & Stang, 2018). Using mean values on daily treated water and daily production of sludge from 2016 for Gardermoen WWTP, which also receives sludge from another WWTP (and its mean daily treated water) (Rusten & Lidholm, 2017), and 118 µg PFAS/kg TS from 2018, results in an estimated mean



PFAS concentration of 54,48 ng/L in the influent wastewater. Figure 2 shows different pathways PFAS take leaving WWTPs.

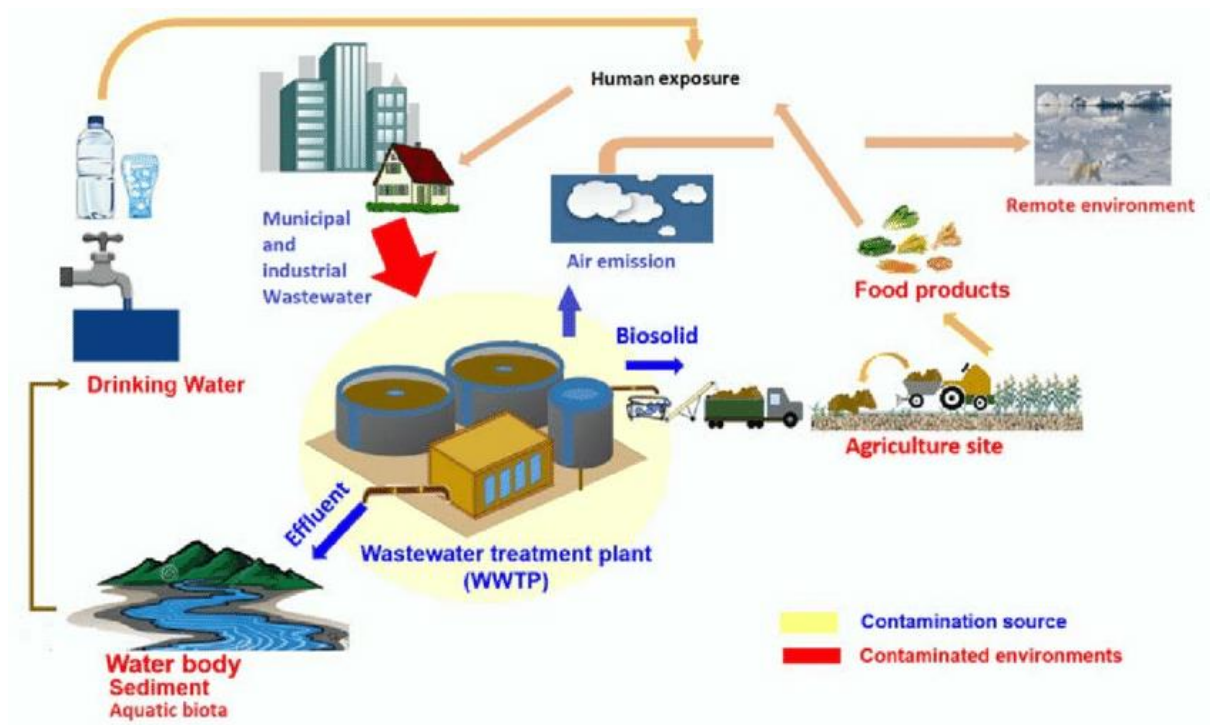
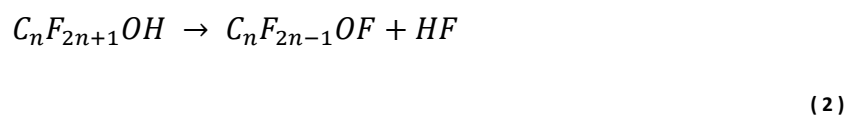
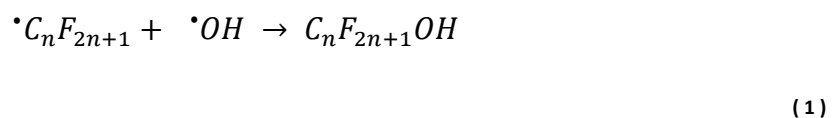
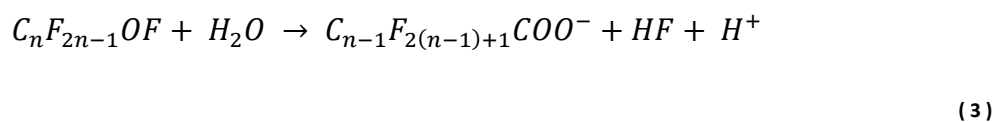

FIGURE 2 – PFAS ENVIRONMENTAL PATHWAYS AFTER LEAVING WWTPS (HAMID & LI, 2016).

Oxidation of PFAS, by-products of PFAS are usually more PFAS, i.e., the by-products of PFOA, which has an acid group connected to its fluorocarbon tail for a total carbon chain length of 8 and shown in Figure 1, are PFHpA, PFHxA, and PFPA. These PFAS are equivalent to PFOA in their functional group, acid group, and a total carbon chain length of 7, 6, and 5 respectively. Further it is more difficult to degrade short chain PFAS than long chain PFAS, and therefore it requires a longer treatment time (Phong Vo et al., 2020).

For complete mineralization of PFAS the degradation is thought to follow a pattern described in (Duinslaeger & Radjenovic, 2022), where it firstly undergoes division with the functional group and the fluorinated carbon chain, where the fluorinated carbon chain is oxidized (shown in eq. ( 1 ) to ( 5 ) form HF, CO<sub>2</sub> and defluorinated by-products:





Where the cycle repeats itself from equation (5) to (1).

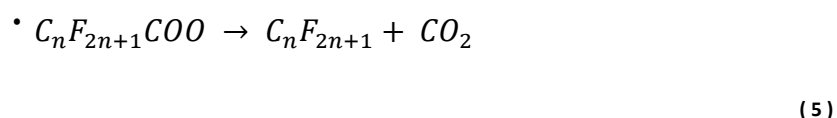
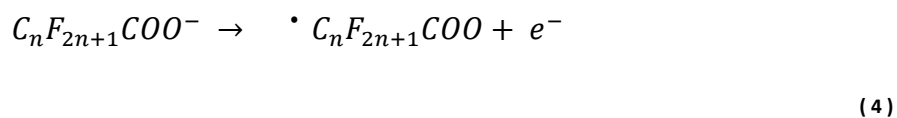

#### 2.2.4. QUANTIFICATION AND CHARACTERISATION METHODS

Quantification and characterisation of wastewater is essential to understand what it constitutes of and subsequently how to treat it. Therefore, it is important to have precise methods that are preferably both cheap and quick. Table 5 presents quantification and characterisation methods.

TABLE 5 – QUANTIFICATION AND CHARACTERISATION METHODS

Method	Description	Pros/cons	Source
<b>Ultraviolet-visible spectrophotometry (UV-VIS)</b>	The use of UV and visible spectrophotometry to measure concentrations of compounds through their absorbance of ultraviolet and visible light. This is done through measuring the intensity of light before and after a sample and taking the logarithm of the intensity before divided by the intensity after giving an absorbance unit. This is done for a range of wavelengths. UV-VIS one of	<b>Pros:</b> <ul style="list-style-type: none"> <li>A quick and cheap methods of analysis to find concentration of compounds.</li> <li>Many organic compounds absorb UV-visible light well, making it well suited for domestic wastewater.</li> </ul> <b>Cons:</b> <ul style="list-style-type: none"> <li>Can only be used for compounds that absorb UV-visible light.</li> <li>Interference, overlapping of absorbance peaks for two compounds, may occur.</li> </ul>	(Thomas & Burgess, 2017)

	many quantification methods to measure COD.		
<b>Liquid chromatography-mass spectrometry</b>	Is the separation of a sample in a solvent to its specific parts through a column of micron-sized particles, where physical and chemical characteristics determines their speed through the column. The separated particles are then measured in a mass spectrometer where electric/magnetic fields determine the specific parts mass-to-charge ratio.	Pros:  Cons:	(Dass, 2007)
		<ul style="list-style-type: none"> <li>• Highly sensitive and selective.</li> <li>• A relatively quick method of analysis to find concentrations of un-/known compounds for its sensitivity and selectivity.</li> </ul> <ul style="list-style-type: none"> <li>• Samples must be prepared in specific ways, where some samples may be incompatible for analysis.</li> <li>• Expensive equipment that has a high cost of analysis paired with high maintenance costs.</li> <li>• Specialized equipment that requires trained personnel to operate.</li> </ul>	

## 2.3. TREATMENT OF ORGANICS IN DOMESTIC WASTEWATER

### 2.3.1. METHODS: OVERVIEW

Conventional wastewater treatment processes are the processes most typically in use, based on cost, removal rate, and traditional knowledge and expertise, Table 6 shows the most normal treatment processes. This makes it easy to choose the same methods when constructing new or expanding existing WWTPs instead of new and possibly better solutions (Ødegaard, 2014). Table 7 shows the removal rate of COD for chemical, biological and chemical-biological WWTPs in Norway.

TABLE 6 – CONVENTIONAL WASTEWATER TREATMENT PROCESSES

Treatment process	Description
<b>Mechanical/physical/pre-treatment</b>	Separation of objects and particles, the goal is to remove objects and particles that inhibit following processes. Conventional processes are screening, sieving, grit removal, filtration, and sedimentation.  (METCALF & EDDY & AECOM, 2014)

**Chemical /coagulation & flocculation** Separation of colloids and particles through the addition of a coagulant, which causes particles to flocculate together and form flocs. This allows for separation from the wastewater stream. Through the addition of polymers, the process can be accelerated. Conventional coagulants are aluminium sulphate, iron chloride sulphate, aluminium chloride, iron(II) sulphate, iron(III) sulphate.  
(Ødegaard, 2014)

**Biological** The use of microorganisms to break down organic matter. There are also biological processes that can remove phosphorus and/or nitrogen, but these require specific conditions to thrive. Biological processes are also more suited to remove organic micropollutants. Conventional processes are suspended growth, fixed film, moving bed biofilm reactor.  
(METCALF & EDDY & AECOM, 2014)

**Separation** The process of removing particles through barriers. This can be achieved with the help of gravity, aeration, the blocking of particles through filters or membranes. Conventional processes are filtration, sedimentation, floatation.  
(Ødegaard, 2014)

TABLE 7 – REMOVAL RATE OF COD FOR DIFFERENT TYPES OF WASTEWATER TREATMENT PLANTS, WITH MECHANICAL/ PRE-TREATMENT (ØDEGAARD & SKRØVSETH, 1997)

Treatment processes	COD removal rate (%)
Chemical	74,8 ± 10,0
Biological	78,9 ± 8,1
Biological/chemical	84,5 ± 7,3
All*	81,2 ± 9,6

\*The average of all plants.

### 2.3.2. OXIDATION METHODS

Oxidative methods utilize oxidizing agents, e.g., Ozone, hydrogen peroxide, chlorine dioxide, to change the electron composition of compounds in the wastewater to break them apart and making them more prone to separation, shown in Table 8. The total reaction using oxidizing agents, goes from organic molecule to intermediate oxygenated molecules to simple end products like CO<sub>2</sub> and H<sub>2</sub>O. Though some oxidation processes may lead to toxic by-products by incomplete oxidation. Therefore separation is normally utilized after an oxidative method (METCALF & EDDY & AECOM, 2014).

TABLE 8 - OXIDATION METHODS

Method	Description
<b>Ozonation</b>	Application of ozone (O <sub>3</sub> ) to the wastewater, through a diffusor, to oxidize in-/organic compounds, and disinfection. Ozone is a strong oxidizing agent with an oxidation potential of 2,1 V* and needs to be created in an ozone generator. Challenges include overdosing which may lead to the formation of bromate and other unwanted by-products due to toxicity or non-biodegradability, complete mineralization of micropollutants is not usually achieved by ozonation. (Lim et al., 2022; Ødegaard, 2014)
<b>Hydrogen peroxide</b>	Application of hydrogen peroxide (H <sub>2</sub> O <sub>2</sub> ) for oxidation of in-/organic compounds, odour control and de-chlorination, in addition it improves biodegradability of wastewater. It's a strong oxidizing agent with an oxidation potential of 1,8 V*, it may also be used with Fe <sup>2+</sup> / <sup>3+</sup> as a catalyst. It doesn't need a generator which means it needs to be stored on-site. Hydrogen peroxide removes organic matter well but is less efficient with compounds like sulphites and sulphides. (Ksibi, 2006)
<b>Chlorine dioxide</b>	Is an oxidizing agent with an oxidation potential of 1,5 V*, uses include removal of organic matter, odour removal and disinfection. The oxidation potential is lower than the previously mentioned agents but is also easier to produce in situ and lasts longer. In addition, it doesn't produce DBPs such as bromate or trihalomethane. Though it does require chemicals onsite for generation.

(Vaezi et al., 2004)

**Advanced oxidation processes (AOPs)** AOPs typically utilize hydroxyl radicals as oxidizing agents with an oxidation potential of 2,8 V\*, that under optimal conditions may achieve full mineralization of many organic compounds. May remove trace compounds and toxic by-products that are not oxidized by conventional oxidative methods. AOPs encompass many treatment methods e.g., hydrogen peroxide with UV or ozone as a catalyst, ozone UV, plasma, etc., including some electrochemical methods (e.g., electrooxidation, electro-Fenton).

(METCALF & EDDY & AECOM, 2014)

\*Measured in volts, (Lenntech, 2022)

### 2.3.3. ELECTROCHEMICAL METHODS

Electrochemical wastewater treatment processes use electricity to accomplish desired effects, e.g., removal of organics, depending on chosen method. When conventional methods of removing organics is inefficient, when removing nonbiodegradable organic molecules. The use of electrochemical methods, presented in Table 9, may be used to greater effect where the process may be controlled through the current density and/or voltage applied (Yasri & Gunasekaran, 2017).

TABLE 9 – ELECTROCHEMICAL METHODS

Method	Description
<b>Electrocoagulation (EC)</b>	The use of sacrificial anodes, typically Al or Fe, in the production of coagulating ions that work much in the same way as described in Table 1. The current used for the EC also reduce the electrostatic repulsion between colloids and particles and aid in flocculation. The process may be enhanced through the addition of electrostatic reducing ions. EC is inexpensive in capital cost, energy consumption and maintenance. Though it not very selective and does require a separation step to remove the produced sludge.  (Yasri & Gunasekaran, 2017)

**Electroflotation (EF)** The use of insoluble electrodes for the generation of oxygen (anode) and hydrogen (cathode) bubbles through electrolysis. This method depends on the presence of particles to separate from the wastewater stream through adhesion. Bubble size is in the range of 20-80  $\mu\text{m}$ . Since there is no addition of chemicals there are no by-products and the formation and dispersion of oxygen gas throughout the liquid may oxidize readily oxidizable compounds and organic matter.

(Sillanpää & Shestakova, 2017)

**Electro-Fenton** The use of electricity for generation of hydrogen peroxide. The process also uses an iron catalyst to produce hydroxyl radicals from the hydrogen peroxide. Which makes it two oxidizing agents acting simultaneously. The generation of hydrogen peroxide allows the iron to regenerate to create more hydroxyl radicals, it also avoids onsite storage of  $\text{H}_2\text{O}_2$ . The reaction is effective against organics and doesn't create toxic by-products. The process shouldn't be placed before a biological step as residual  $\text{H}_2\text{O}_2$  may inhibit its effectiveness.

(Zhou et al., 2017)

**Electrochemical oxidation** Described in the following chapter.

#### 2.3.4. ELECTROCHEMICAL OXIDATION

“Electrochemical oxidation (EO) is a chemical reaction, involving the loss of one or more electrons by an atom or molecule at the anode surface made of catalyst material during the passage of direct electric current through the electrochemical systems (anode, cathode, and an electrolyte solution)” (Sillanpää & Shestakova, 2017). Electrons enter the electrolyte at the cathode-electrolyte interface causing a reduction. At the anode-electrolyte interface electrons leave the electrolyte causing oxidation.

In treatment of organics in water using electrochemical oxidation, there are two main mechanisms, direct and indirect (shown in Figure 3). Direct oxidation happens at the anode surface, where the pollutants are oxidized. Producing oxidized pollutants,  $\text{CO}_2$ ,  $\text{NH}_3$  and  $\text{H}^+$ . This can only occur when the anode is made of a catalytic material. Indirect oxidation uses the

creation of highly reactive ions/molecules (hydroxyl radicals, hydrogen peroxide, ozone, persulphate and sulphate radicals, etc.), at the anode surface from the water or mediators from the electrolyte (Karim et al., 2021). Such mediators can be chlorine, sulphate, or oxygen. The highly reactive ions/molecules circulate into the bulk solution and react with organic compounds. Resulting in the same products except  $H^+$  is substituted with  $H_2O$  (Sillanpää & Shestakova, 2017).

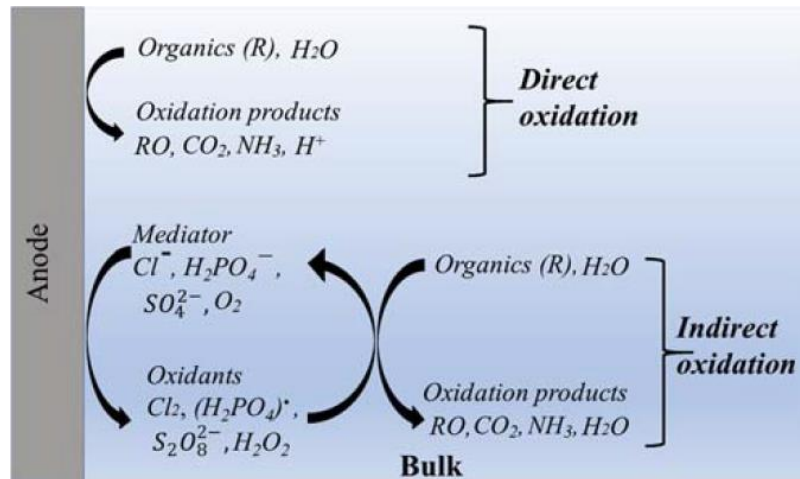

FIGURE 3 – DIRECT AND INDIRECT ELECTROCHEMICAL OXIDATION OF ORGANIC COMPOUNDS (SILLANPÄÄ & SHESTAKOVA, 2017)

Current density is an important factor in electrochemical oxidation, it is directly related to the number of electrochemical reactions taking place at the surface of the electrode per time, the electrochemical reaction rate, from Faraday's law. Which means it determines the production of hydroxyl radicals and inorganic oxidants from the electrolyte. Current density is defined as (Sillanpää & Shestakova, 2017):

$$j = \frac{I}{A} \times \frac{1}{1000}$$

(6)

Where:

- $j$  – Current density (mA/cm<sup>2</sup>)
- $I$  – Current (A)
- $A$  – effective electrode area (cm<sup>2</sup>)



While the cathode usually is made up of steel, titanium or graphite, the choice of anode material is more extensive. It should be stable, have a high oxygen potential and not be spent, non-sacrificial. Noble metals like palladium and platinum and metal oxide coated anodes have been used traditionally. More recently metal nanoparticles, nonmetal nanoparticles and boron-doped diamond (BDD) coating over graphite anodes have been used (Yasri & Gunasekaran, 2017).

BDD electrodes are electrochemically stable, resistant to corrosion, have a high oxygen overpotential and a high current efficiency. The BDD coating, as seen in Figure 4, has a rough surface of diamond crystals which increases the effective electrode surface which can increase the removal of organics. Though BDD has many good qualities, it is associated with a high cost of production. Non-doped diamond is considered as an electrical insulator, but the process of boron doping makes the BDD viable as an electrode (De Luna & Bensalah, 2022). The diamond coating is applied to the base through energy assisted chemical vapor deposition (plasma or hot filament), it is during this process the boron-doping occurs (Yasri & Gunasekaran, 2017).

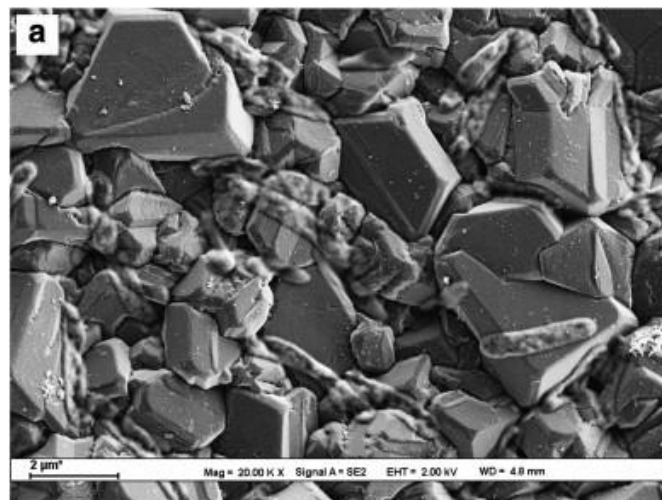

FIGURE 4 – SCANNING ELECTRON MICROSCOPY (SEM) OF A BDD ELECTRODE AFTER 2 HOURS OF OPERATION (WU ET AL., 2011).

The main mechanisms for electrooxidation of pollutants with BDD anodes are the creation of hydroxyl radicals at the surface of the electrode (BDD in this case) and consequent oxidation of pollutant (Clematis & Panizza, 2021):



(7)



(8)

When a mediator such as sulphate or chlorine is present inorganic oxidants may be generated as well (Clematis & Panizza, 2021):

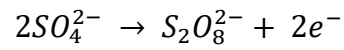

(9)

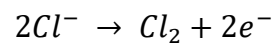

(10)



(11)

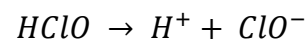

(12)

#### 2.4. KNOWLEDGE GAP AND RESEARCH OBJECTIVES

Electrochemical oxidation is becoming more widespread as a treatment option, especially in industrial wastewater as the process is effective against many pollutants (Clematis & Panizza, 2021; Ma et al., 2021). The removal efficiency of BDD electrodes is also notable and is proven efficient in the removal of PFAS (Karim et al., 2021). The use of electrochemical oxidation is less used for the removal of organics in domestic wastewater treatment due to high energy consumptions. With the need to remove contaminants of emerging concern from domestic wastewater, there is a need for better understanding of the removal of multiple PFAS from domestic wastewater matrices by electrochemical oxidation (McBeath et al., 2021; Phong Vo et al., 2020).

As a part of the SEKRENS project my master thesis will involve experiments with an electrooxidation bench unit mainly to investigate removal rates of nine per- and polyfluoroalkyl substances (PFAS), of which all of them are on the EUs list of PFAS of concern for human consumption that shall not exceed 100 ng/L in drinking water, the production of by-products and the measurability of these using UV-VIS.

The main research questions/objectives are:

- Efficiency of numerous per- and polyfluoroalkyl substances (PFAS) oxidation – in model water.
- Potential by-products from oxidation of PFAS.
- Are UV-VIS spectral measurements made on PFAS in model water correlated to its state under EO treatment?

### 3. MATERIAL AND METHODS

#### 3.1. SYSTEMATIC REVIEW

Systematic review of studies for the design of experiments for this thesis were based on their applicability and relevance to the research objectives presented in chapter 2.4. Databases used for literature review were Science Direct, Research Gate and Google Scholar and some sources were found in the reference list of articles found through the databases. The literature search and review were done based on the PRISMA statement and flow of information diagram (Moher et al., 2009).

In recent years there have been done many studies for electrooxidation with various types of electrodes. In the beginning searches were broad with just “electrooxidation”, but these were quickly narrowed. Multiple searches were done with topic-specific search words; “BDD”, “boron-doped diamond”,- “electrodes”, “domestic/municipal/real wastewater”, “removal of organics” for the application of electrooxidation on municipal wastewater. Searches were also conducted according to the removal of PFAS, with terms like “PFAS”, “per- and polyfluoroalkyl substances” in addition to the former terms.

#### 3.2. SFR CASE STUDY

A well run mechanical-chemical treatment plant may uphold the secondary treatment demand. There may be problems with this due to fluctuations in the wastewater composition and volume, where sudden shifts may cause exceedances in the discharge limits.

As described in chapter 1.1, the secondary treatment demand puts a discharge limit of 25 mg/l or 70% removal of BOD and 125 mg/l or 75% removal of COD of effluent wastewater for treatment plants with a capacity higher than 10 000 PE. To meet this guideline, the limit is to be maintained for at least 21 of 24 tests over a year.

##### 3.2.1. SEKRENS

With a planned capacity increase at Søndre Follo WWTP[SFR] it is presumed periodically exceedances of the discharge limits. As the project name implies its goal is to meet the secondary treatment demand with chemical precipitation/coagulation without implementing a full biological step. As this will be cheaper and therefore cheaper for the residents/consumers who pay for the water and wastewater treatment.

SEKRENS is looking into four main possibilities to achieve the secondary treatment demand without a full biological step.

- Optimal dosing of coagulant
- New/alternative coagulants
- The implementation of a small biological step, either a sub stream of the total treatment or in use for the reject water streams that are sent back into the treatment
- **Advanced oxidation processes (AOPs)**

There is no use of AOPs in municipal wastewater treatment in Norway (SEKRENS). In places with a need of removal of COD/BOD chose biological treatment. As Søndre Follo already processes its wastewater chemically it removes COD well and it is not necessary to remove >70% of the COD through AOPs, but only when COD is exceeding the discharge limits. Therefore, it only needs to remove from 60-70 - >70%. Even though the study is on SFR it can be applied to other mechanical-chemical WWTPs that occasionally exceed the discharge limits.

### 3.2.2. SØNDRE FOLLO TREATMENT PLANT

Søndre Follo treatment plant is a mechanical-chemical treatment plant that operates for Vestby and Ås municipalities. The WWTP serves ca. 29 000 PE and treats 3 million m<sup>3</sup> of wastewater every year (Søndre Follo Renseanlegg IKS, 2017, 2019).

The process consists of the inlet (1), step screen (2), two dosing points for coagulants, one before and one after the sand trap (3), a dosing point for the addition of polymer, a flocculation basin (with a grease trap) (4), followed by a sedimentation tank (5), the whole flowsheet for the processes is shown in Figure 5. After the sedimentation tank the water has completed its treatment and is led to the outlet. The sludge from the sedimentation tank is processed and the reject water from the sludge thickener and the sludge centrifuge is diverted to a reject water basin where it is returned to the treatment process again near the inlet (Søndre Follo Renseanlegg IKS, 2019).

SØNDRE FOLLO RENSEANLEGG IKS  
RENSEPROSESSEN STEG FOR STEG

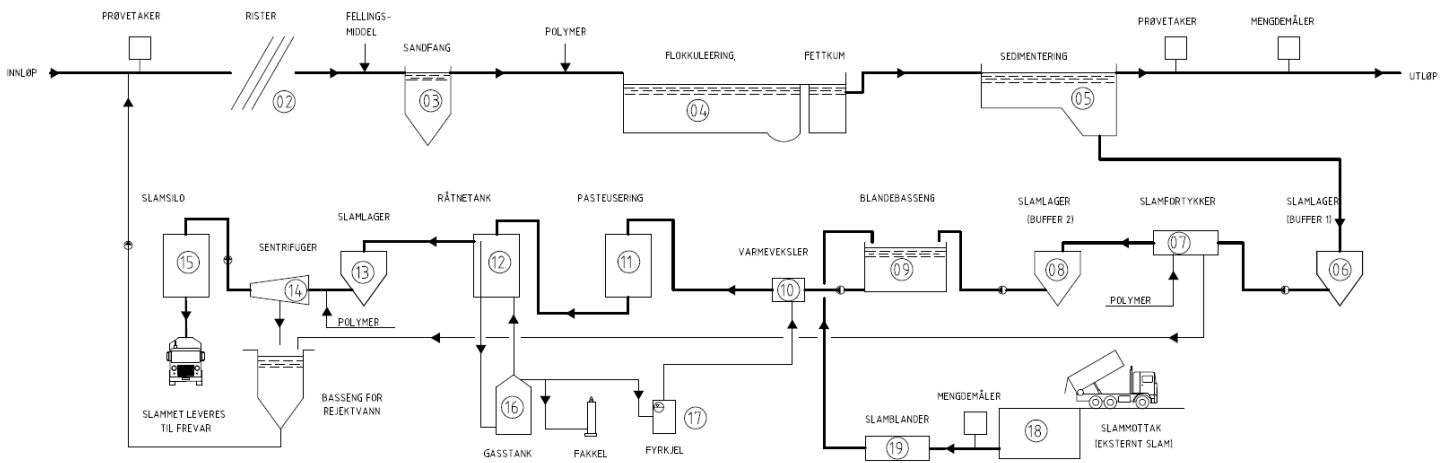
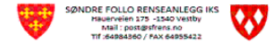

FIGURE 5 – FLOWSHEET OF SØNDRE FOLLO TREATMENT PLANT (Søndre Follo Renseanlegg IKS, 2017)

The wastewater enters the treatment plant through the inlet (1), where the inlet flow is monitored, and the quality of the wastewater is measured. The mean inlet flow is 470 m<sup>3</sup>/h. To prevent the exceedance of inlet water, there is an overflow for when the inlet flow exceeds 850 m<sup>3</sup>/h, which is led to the Oslo fjord (Søndre Follo Renseanlegg IKS, 2019).

The step screens (2) remove larger objects that enter the treatment plant. With an aperture of 3mm the two screens remove things commonly thrown in the toilet that is unwanted throughout the treatment process and in the effluent, such as rags, sanitary articles, cotton swabs, etc. The items removed are washed and sent to a landfill (Søndre Follo Renseanlegg IKS, 2019).

The plant has two aerated sand traps (3), which remove sand and other heavy easily sedimented particles that quickly fall to the bottom of the water and air mixture. This is then removed by an airlift pump. The sand is washed using a *MEVA sandvask SWA 10*. It washes the sand, reducing its organic content from 30-80% to 1-5%, and dewater the reject water. The sand is sent to a landfill and the dewatered reject water is sent back to the wastewater stream after the screens (Søndre Follo Renseanlegg IKS, 2019).

As a coagulant the treatment plant uses the chemical PAX18. It has the possibility to dose this before or after the aerated sand trap. Based on a statistical model the plant decides the

dosage and dosing point. The statistical model is based on pH, incoming waterflow, conductivity and turbidity (Søndre Follo Renseanlegg IKS, 2019).

After dosing the coagulant to the wastewater stream it enters the flocculation basin (4), which consist of three tanks/individual flocculation tanks(chambers). Each chamber has its own agitator or paddle mechanism. The rotational speed of the paddles decreases from the first chamber to the second and again to the last. The polymer is added in the first chamber. The polymer used is Superflock A-130. The final flocculation chamber acts as a flotation chamber in addition to flocculating. Here, grease and other elements that float is removed (Søndre Follo Renseanlegg IKS, 2019).

The wastewater stream continues to the sedimentation tanks. The plant has 6 sedimentation basins, with four tanks of 161 m<sup>3</sup> capacity and two of 432 m<sup>3</sup> capacity. The average residential time is approximately 4,5 hours. The flocs and other fractions that sink, sink to the bottom where they are removed by scrapers as sludge and are treated in the sludge treatment process. The reject water from both the sludge thickening process and centrifuges is then collected in a basin for reject water, from where it is added back to the beginning of the wastewater stream (Søndre Follo Renseanlegg IKS, 2019).

### 3.3. BENCH SCALE TESTING

The electrolyser is a product of *DiaCCon GmbH*. It is equipped with two stainless-steel cathodes and one boron-doped diamond (BDD) electrode housed in a polypropylene [PP] casing. The electrolyser operates as wastewater is pumped from the bottom to top, shown in Figure 6, while current is run through the electrodes via the contact bolts setup in Figure 8. This causes electrolysis in the electrolyte. The process also creates hydrogen gas that needs to be vented off. The conical shape of the outlet prevents build-up of gas in the reactor, therefore the reactor has to be vertical, shown in Figure 8 (DiaCCon GmbH, 2019). Figure 7 shows a sideways view of the electrode stack.



FIGURE 6 - INSIDE VIEW OF THE ECO EXPERIMENTAL UNIT, NEAREST NOZZLE IS THE INLET.

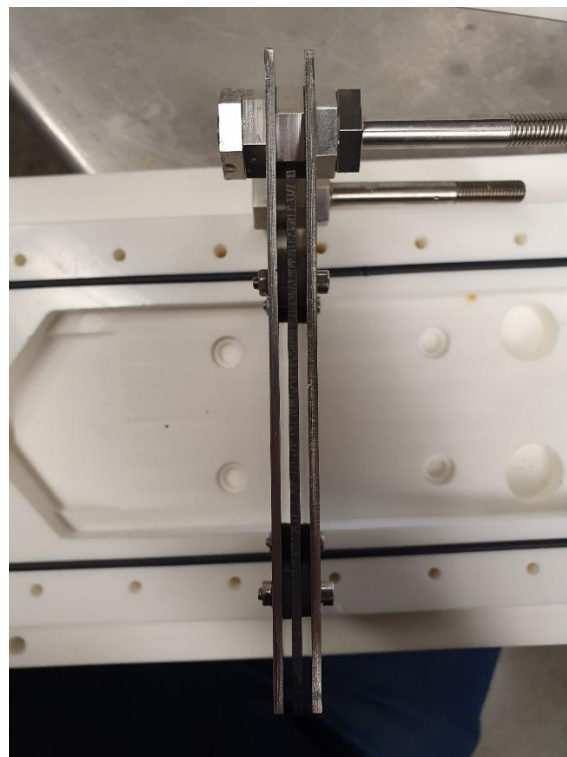

FIGURE 7 - SIDEWAYS VIEW OF THE ELECTRODE STACK, WITH A 2MM ELECTRODE GAP.

Table 10 shows the technical data for the electrochemical reactor from the manufacturer.



TABLE 10 – TECHNICAL DATA FOR THE ELECTROCHEMICAL REACTOR FROM THE MANUFACTURER.

### Technical data, materials

<b>Electrolyser:</b>	“Susi” type electrolyser 280 x 270 x 60 (External dimensions)
<b>Electrode:</b>	Boron-doped diamond on niobium basis
<b>Anodic area:</b>	0,016 m <sup>2</sup> (110 mm x 73 mm)
<b>Maximum current density:</b>	100 mA/cm <sup>2</sup>
<b>Maximum voltage:</b>	25 V DC
<b>Electrode gap:</b>	2 mm
<b>Maximum operating pressure:</b>	0,5 bar
<b>Minimum flow:</b>	2,5 L/min
<b>Maximum operating temperature (electrolyte):</b>	40 °C
<b>Casing material:</b>	PP, temperature resistant up to max. 70 °C
<b>Casing gasket:</b>	Viton
<b>Anode side contact material:</b>	Titanium
<b>Cathode side contact material:</b>	Stainless steel
<b>Power supply contacts:</b>	Titanium / copper
<b>Shim and insulation material between electrodes:</b>	Teflon
<b>Forward and backward flow:</b>	nozzle ID 9 mm
<b>Weight:</b>	2,3 kg

(DiaCCon GmbH, 2019)

## 3.4. DESIGN OF EXPERIMENTS

### 3.4.1. EQUIPMENT

- Polypropylene / High Density Poly Ethylene containers
- Weighing scale (VWR SE 203-LW) (3 decimal / 1 mg)
- Magnetic stirrer, with magnetic stir bar (IKA KMO 2 basic IKAMAG)
- Peristaltic pump (SHENCHEN V6 pump fitted with 3 YZ1515x pump heads)

- Power supply (Aim TTi CPX400DP dual 420 watt DC Power Supply)
- BDD ECO reactor, as described in chapter 3.3
- Thermometer / pH-meter (JENWAY 370 pH Meter)
- PP sampling tubes (15 ml)
- Pipettes (0,5 – 10 ul, 10 – 1000 ul, 1 – 10 ml)
- Gas meter (Dräger X-am 2500)

#### 3.4.2. MATERIALS

- De-ionized water
- Sodium sulphate anhydrous Sigma-Aldrich / decahydrate VWR
- PFAS Stock in methanol, composition shown in Table 11

TABLE 11 – CONSTITUENTS OF THE PFAS SOLUTION AND THEIR CONCENTRATIONS.

CASnr.:	Common name	Carbon chain length	Concentration (g/L)	Distribution of contents (%)
375-22-4	PFBA	C4	1,1214	11,4
2706-90-3	PFPA	C5	1,67579	17,0
307-24-4	PFHxA	C6	0,9942	10,1
375-85-9	PFHpA	C7	1,0326	10,5
335-67-1	PFOA	C8	1,0086	10,2
375-95-1	PFNA	C9	0,9992	10,1
335-76-2	PFDA	C10	1,0009	10,1
2058-94-8	PFUnDA	C11	1,0302	10,4
307-55-1	PFDODA	C12	1,0098	10,2
		Sum	9,87269	100,0

- Tap water
- Ice/icepacks

#### 3.4.3. PFAS SOLUTION

The solution was prepared as follows:

- A measuring cylinder was filled with 1000 ml of de-ionized water.
- The de-ionized water was transferred to a 1 L PP/HDPE container, which was placed in the magnetic stirrer.

- iii. A mass of 7,102 g of sodium sulphate anhydrous or 16,110g of sodium sulphate decahydrate was weighed and added to the de-ionized water, and the stirrer was set to 900 rpm.
- iv. Once the sodium sulphate was dissolved, x  $\mu$ L of 9,8727 g/L PFAS stock (Factor 3 in Table 12) was added to the water-electrolyte solution using a pipette and stirring (900 rpm) was continued for 5 minutes.

#### 3.4.4. RESPONSE FACTORS

Table 12 show the statistically randomised matrix for the parameters for use in the experiments based on composite design. The parameters for Table 12 are shown in Table 13.

**TABLE 12 – STATISTICALLY RANDOMISED MATRIX USING CENTRAL COMPOSITE DESIGN FOR RESPONSE SURFACE.**

Std	Run	Factor 1 A:Flow rate L/min	Factor 2 B:Current density mA/cm2	Factor 3 C:Initial concentration PFAS ppm	Response 1 Residual concentration PFAS ppm	Response 2 UV254 abs
4	1	1,5	200	3		
15	2	1	137,5	6,5		
19	3	1	137,5	6,5		
1	4	0,5	75	3		
9	5	0,15910358	137,5	6,5		
18	6	1	137,5	6,5		
13	7	1	137,5	0,613725093		
5	8	0,5	75	10		
8	9	1,5	200	10		
16	10	1	137,5	6,5		
12	11	1	242,6120519	6,5		
6	12	1,5	75	10		
20	13	1	137,5	6,5		
2	14	1,5	75	3		
14	15	1	137,5	12,38627491		
7	16	0,5	200	10		
3	17	0,5	200	3		
11	18	1	32,38794809	6,5		
17	19	1	137,5	6,5		
10	20	1,84089642	137,5	6,5		

TABLE 13 - PARAMETERS FOR THE STATISTICALLY RANDOMISED MATRIX.

Build Information										
File Version	13.0.9.0									
Study Type	Response Surface	Subtype	Randomized							
Design Type	Central Composite	Runs	20							
Design Model	Quadratic	Blocks	No Blocks							
Factor	Name	Units	Type	SubType	Minimum	Maximum	Coded Low	Coded High	Mean	Std. Dev.
A	Flow rate	L/min	Numeric	Continuous	0,1591	1,84	-1 ↔ 0,50	+1 ↔ 1,50	1,0000	0,4239
B	Current density	mA/cm2	Numeric	Continuous	32,39	242,61	-1 ↔ 75,00	+1 ↔ 200,00	137,50	52,99
C	Initial concentration PFAS	ppm	Numeric	Continuous	0,0614	1,24	-1 ↔ 0,30	+1 ↔ 1,00	0,6500	0,2967
Response	Name	Units	Observations	Minimum	Maximum	Mean	Std. Dev.	Ratio		
R1	Residual concentration PFAS	ppm	20 No Data	No Data	No Data	No Data	No Data	N/A		
R2	UV254	abs	20 No Data	No Data	No Data	No Data	No Data	N/A		

### 3.4.5. ELECTROOXIDATION

The container with the solution was placed in a wide beaker (which acted as a water-/ice bath to maintain the temperature). The whole setup excluding the power supply was set in a fume hood to vent of fumes and hydrogen gas, shown in Figure 8. The container was connected to the reactor via the pump, and the effluent of the reactor returned to the container for recirculation. A thermometer/pH meter was set into the container to monitor temperature and pH. The peristaltic pump was turned on with a fixed flow rate of  $y$  mL/min (Factor 1 in Table 12). The water bath was supplied with water and ice as needed, and excess water removed. A gas meter was placed on the exterior of the fume hood in case hydrogen gas escaped. Before the power supply was turned on, an initial  $\sim 4$  mL sample [ $m_0$ ] of the water undergoing treatment was collected from the container.

A power supply was used to provide a fixed current of  $z$  A to achieve the correct current density ( $\text{mA}/\text{cm}^2$ ) (Factor 2 in Table 12 show the statistically randomised matrix for the parameters for use in the experiments based on composite design. The parameters for Table 12 are shown in Table 13.

Table 12). The power supply was then turned on to initiate current to the reactor. The temperature was monitored as to ensure that it did not exceed  $40,0$  °C. Samples (10 mL) of the solution were collected using a pipette from the reservoir after 5, 10, 15, 30, 60 and 90 minutes of treatment, corresponding to a total volume of  $\sim 64$  ml (i.e.,  $\sim 6,4\%$  of the total volume). The collected samples were stored in a refrigerator at  $6$  °C until further analysis.

Figure 8 and Figure 9 shows the whole setup and a close-up of the setup in the fume hood. While Figure 10 presents a flowsheet view of the setup.

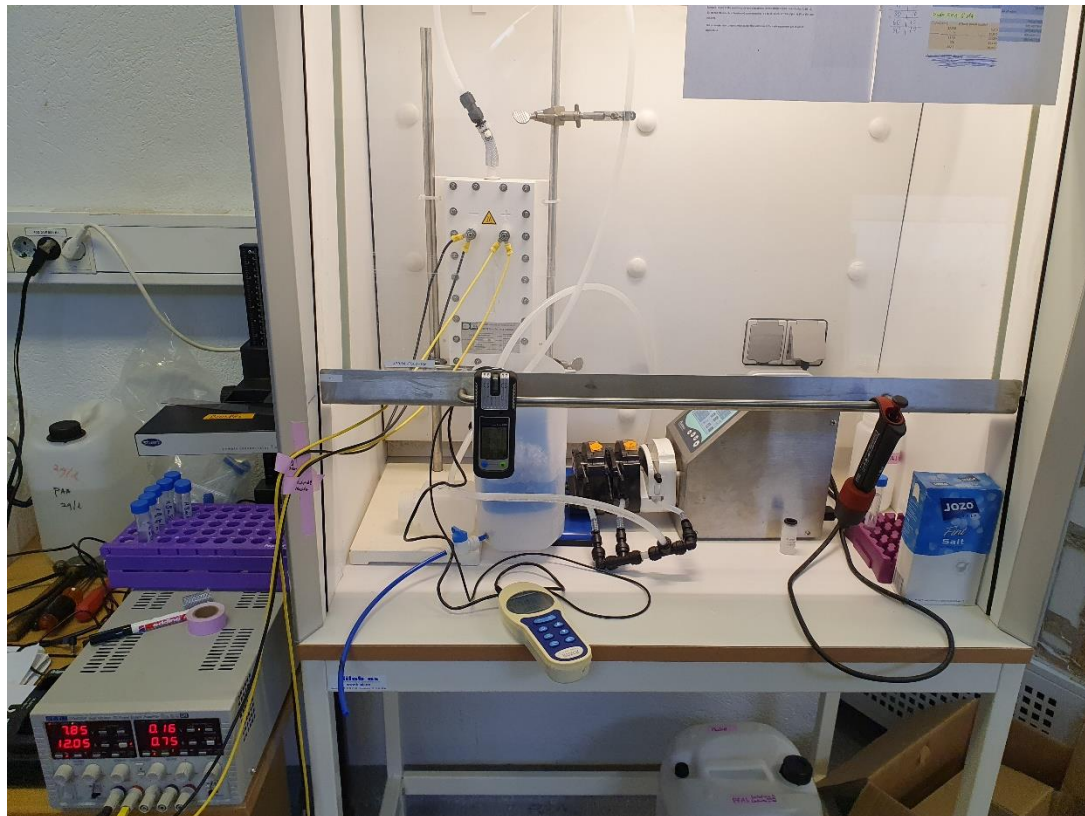

**FIGURE 8 – THE SETUP IN A FUME HOOD.**



FIGURE 9 – CLOSE UP OF THE RESERVOIR.

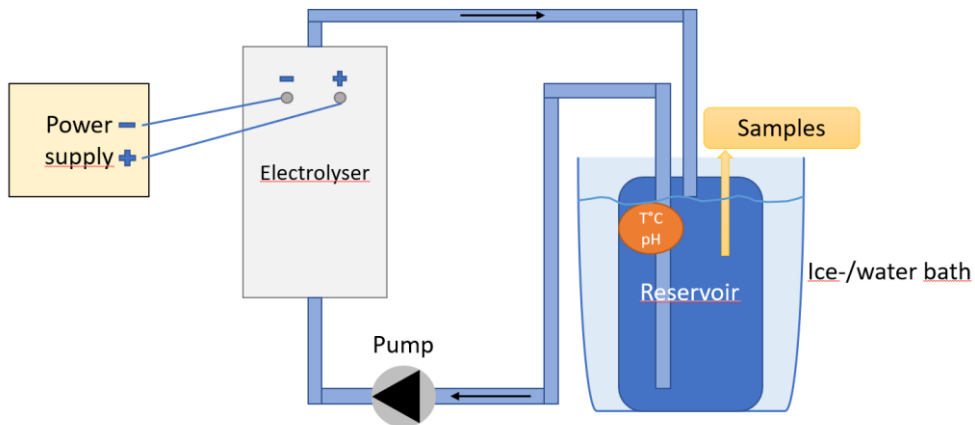

FIGURE 10 – FLOWSHEET OF THE SETUP.

The peristaltic pump was calibrated for each flowrate due to the configuration of the pump, presented in Appendix 5. –. The pH-meter was calibrated to a pH of 4,00 and 7,00 at the start of each day of the runs.

#### 3.4.5.1. REASONINGS

- The concentration of PFAS in the solution was purposefully put quite high, because there were some concerns to the detection limit at the time.

- Flowrates for the peristaltic pump were chosen based on the physical limitations of the pump.
- Current densities were chosen based literature and set to a wide-ranging interval to determine the best current density.
- Sodium sulphate was chosen for the electrolyte for the production of persulphate. Chosen over chlorate-based electrolyte due to the possible production of chlorate and perchlorate (Veciana et al., 2022).

### 3.5. ANALYTICAL TECHNIQUES

UV-VIS spectra were taken with a UV-T500PRO spectrophotometer. A baseline was set with  $\text{Na}_2\text{SO}_4$  and  $\text{Na}_2\text{O}_4\text{S}\cdot 10\text{H}_2\text{O}$  depending on which salt were used for the electrolyte of the run. The UV spectra were set to wavelengths of 750 nm to 200 nm for a broad view with intervals of 0,5 nm. Each sample was run twice for two absorbance spectra. Polypropylene cuvettes were used for UV-analysis.

LC-MS - details of the method:

For samples m10 – m90; 500  $\mu\text{l}$  water was diluted with 500  $\mu\text{l}$  methanol. For samples m0 and m5 100 $\mu\text{l}$  the samples were diluted with 400 $\mu\text{l}$  water and 500  $\mu\text{l}$  methanol.

Samples were analysed on Agilent 6495 mass spectrometer with Agilent 1290 HPLC-system with delay column: Luna Omega 3  $\mu\text{m}$  PS C18 50 x 4,6 mm placed between pump and injector and analytical column: Luna Omega 1,6  $\mu\text{m}$  PS C18 100 x 2,1 mm. Injection volume was 1 $\mu\text{l}$ . Mobile phase A was 10 % MeOH in water and B was 100 % MeOH both containing 2 mM ammonium acetate. Gradient program was 40%B increased to 100% B over 3 minutes and held at 100% B for 2 minutes. Quantification was done by external calibration with a calibration curve ranging from 0,1ng/ml to 500ng/ml.

Parameters for the mass spectrometer is in the acquisition method report in Appendix 4. – Acquisition Method Report for LC-MS.

PFPA (C5) was not included in the calculated concentrations due to not having standards for converting peak (area) to concentrations.





## 4. RESULTS AND DISCUSSION

### 4.1. CONCENTRATIONS AND REMOVAL RATES

Figure 11 shows the concentration of PFAS, in ng/L, throughout all the runs. In the first 5 minutes of run, three observations can be seen. In some cases, the concentrations stay in the same order of magnitude from sampling before the runs were initiated at minute 0 [m0] to sampling at m5 (e.g., Run 14). Secondly, a significant increase in concentration of PFAS can be seen in some cases (e.g., Runs 9, 15). In the rest of runs (e.g., Run 7, 11, 17), there is a gradual decrease in PFAS concentration. At the 60-minute mark 16 runs are below 70 000 ng/L. At m90 there are 17 runs with a concentration between 600 and 24 000 ng/L.

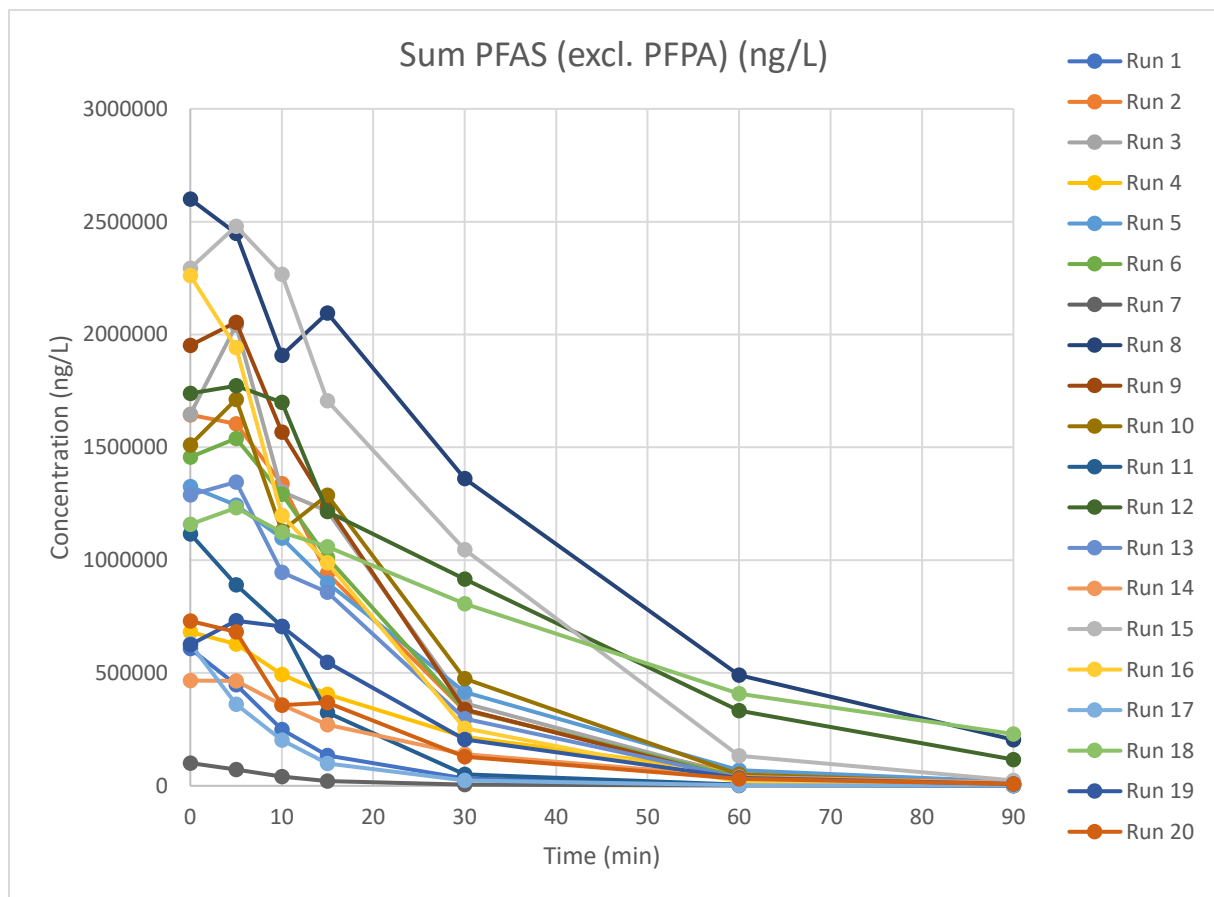

FIGURE 11 – A LINE GRAPH SHOWING THE CONCENTRATIONS OF THE SUM OF PFAS FOR EACH RUN (1-20) OVER TIME.

Figure 12 shows removal efficiency in all the runs over time. In Figure 12, at m15 there are four runs, 7, 1, 11 and 17, that show a removal efficiency above 70%: 79,51%, 77,90%, 70,88% and 84,23% respectively. At m30 there are 11 runs with an efficiency above 76%, where 7 are between 88% and 96%. At m90 only run 18 has a removal efficiency below 90%. The highest achieved removal efficiency is at 99,86%.

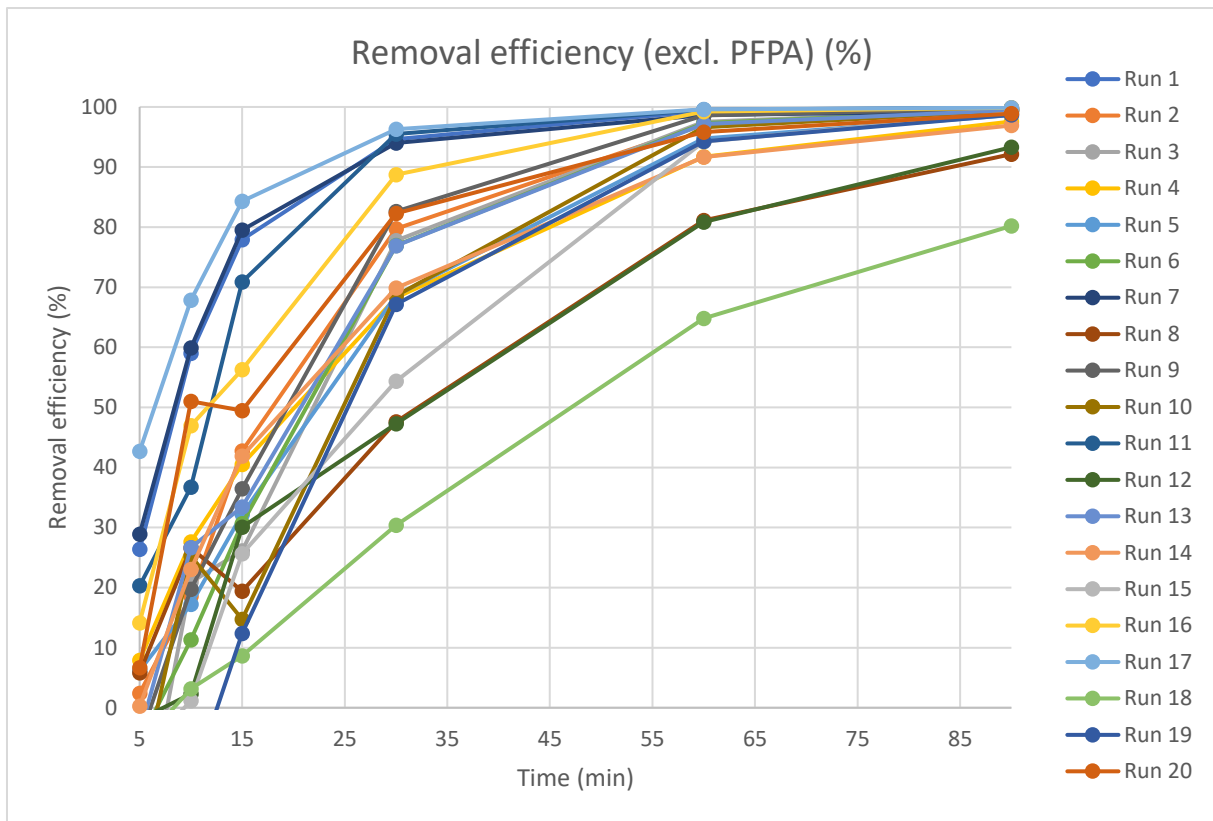

FIGURE 12 – A LINE GRAPH SHOWING THE REMOVAL EFFICIENCY OF THE SUM OF PFAS FOR EACH RUN (1-20) OVER TIME.

#### 4.2. PREFERRED SETUP OF PARAMETERS

Design Expert was used to create the DoE and the response factors as described in chapter 3.4.4 “response factors”, as well as Table 12 and Table 13. Where the factors were flow rate, current density and initial concentration of PFAS, which would responses observe in residual concentrations of PFAS and UV absorbance.

The build report from Design Expert is shown in Appendix 6. – Design Expert build report. The correlations between residual PFAS concentration and flow rate and initial PFAS concentration were not statistically significant to state anything with certainty. Residual PFAS concentrations used for this were taken from the samples taken at 60 minutes. The correlation between residual PFAS concentration and current density is at  $R^2 = -0,675$ . Figure 1 shows residual PFAS concentrations plotted against current density.

Correlation: -0.675  
 Color points by  
 Run  
 1 20

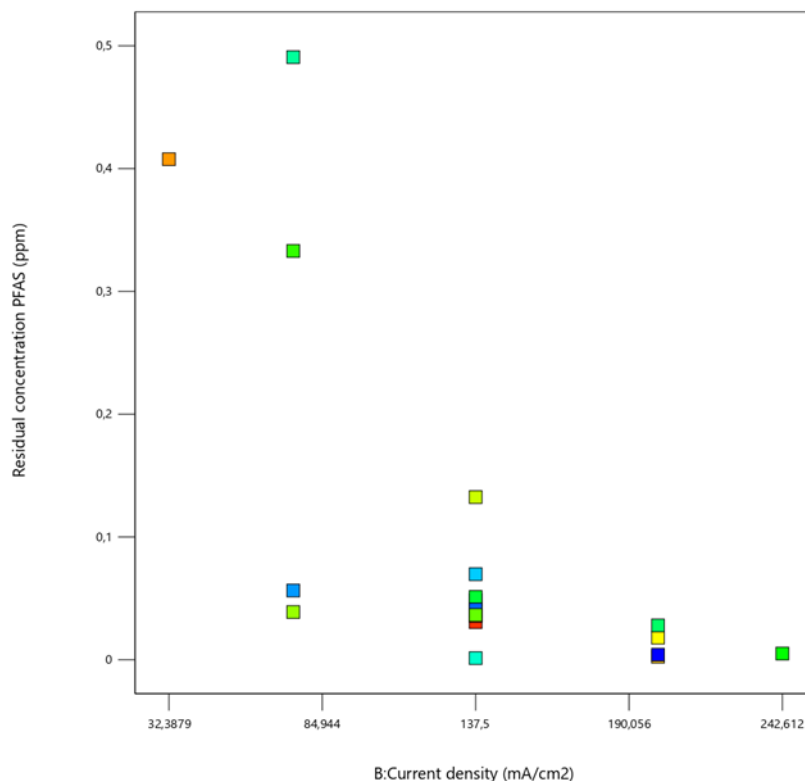

FIGURE 13 - A POINT DIAGRAM SHOWING RESIDUAL PFAS CONCENTRATION PLOTTED AGAINST CURRENT DENSITY AND SHOWING CORRELATION.

From Figure 12 see the runs with the highest removal efficiency at m15 are run 17, 11, 1 and 7 have high current densities and concentrations on the lower end of the spectrum, shown in table following. Which indicates at m15 the best parameters are a high current density (137,5-242,61 (mA/cm<sup>2</sup>) and a low concentration in terms of this set of experiments (0,1-0,6 ppm) are preferable.

TABLE 14 – A TABLE SHOWING THE 4 RUNS WITH THE BEST REMOVAL EFFICIENCIES AT 15 MINUTES, DISPLAYING CD, THEORETICAL-/MEASURED INITIAL CONCENTRATION AND THEIR REMOVAL EFFICIENCIES.

Run	Current density (mA/cm <sup>2</sup> )	Theoretical initial concentration (ppm)	Measured initial concentration (ppm)	Removal efficiency at m15 (%)
17	200	3,001	0,629	84,23
11	242,61	6,496	1,12	70,88
1	200	2,997	0,608	77,90
7	137,5	0,614	0,107	79,51

At 30 minutes there are still the 4 previous runs at the top with a removal efficiency of >94% for all of them, a run 17 with a removal efficiency of 96,3%.

#### 4.3. REMOVAL RATE PER PFAS BASED ON CARBON CHAIN LENGTH

Figure 14 shows the different PFAS compounds by percent of the total solution over time in a stacked area diagram with a percentage distribution numerated on the left vertical axis, and the sum of PFAS in the solution over time as a line graph numerated on the right vertical axis. The figure shows that over time the PFAS compounds are degraded from long carbon-chained PFAS to lower carbon-chained PFAS, as described in chapter 2.2.3 “PFAS”, on the theoretical degradation of PFAS. This pattern is repeated in all the runs with some variations. As seen in Figure 14 the distribution of PFAS is around what we would expect from Table 11. From m0 to m30 we see an increase in percentwise concentration of the lower chained PFAS especially PFBA (C4), but also PFHxA (C6). Followed by a peak/plateau, in figure 1 at 30-60 minutes. After 30-60 minutes there are distribution equals out when there are fewer PFAS altogether. This reduction is not visible in the percentage distribution until after 60 minutes due to the comparable higher removal efficiency of the longer chained PFAS. This can be seen in Figure 15, which presents the concentrations of the different PFAS compounds in a grouped bar chart. Where we see a more linear degradation pattern of PFBA (C4) with an earlier degradation of the longer chained PFAS.

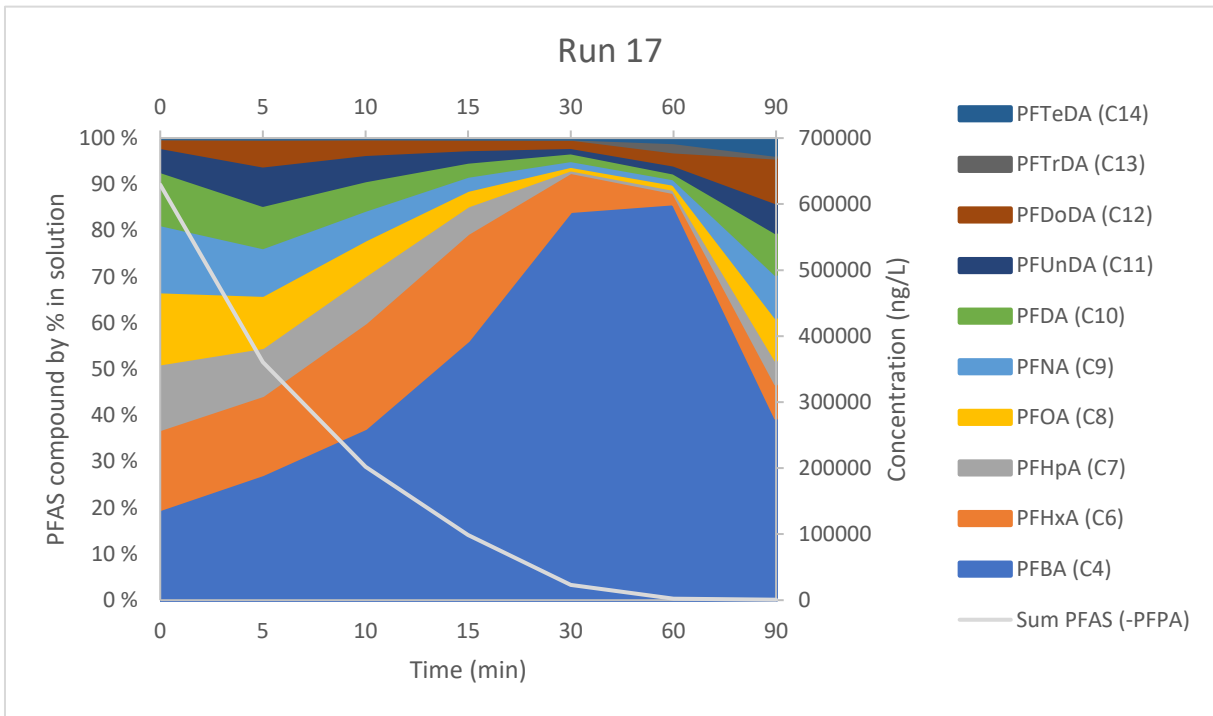

**FIGURE 14 - TWO AXIS DIAGRAM, WITH A LINE GRAPH FOR THE SUM OF PFAS, AND A STACKED AREA DIAGRAM WITH A PERCENTAGE DISTRIBUTION OF THE DIFFERENT PFAS COMPOUNDS IN THE SOLUTION OVER TIME.**

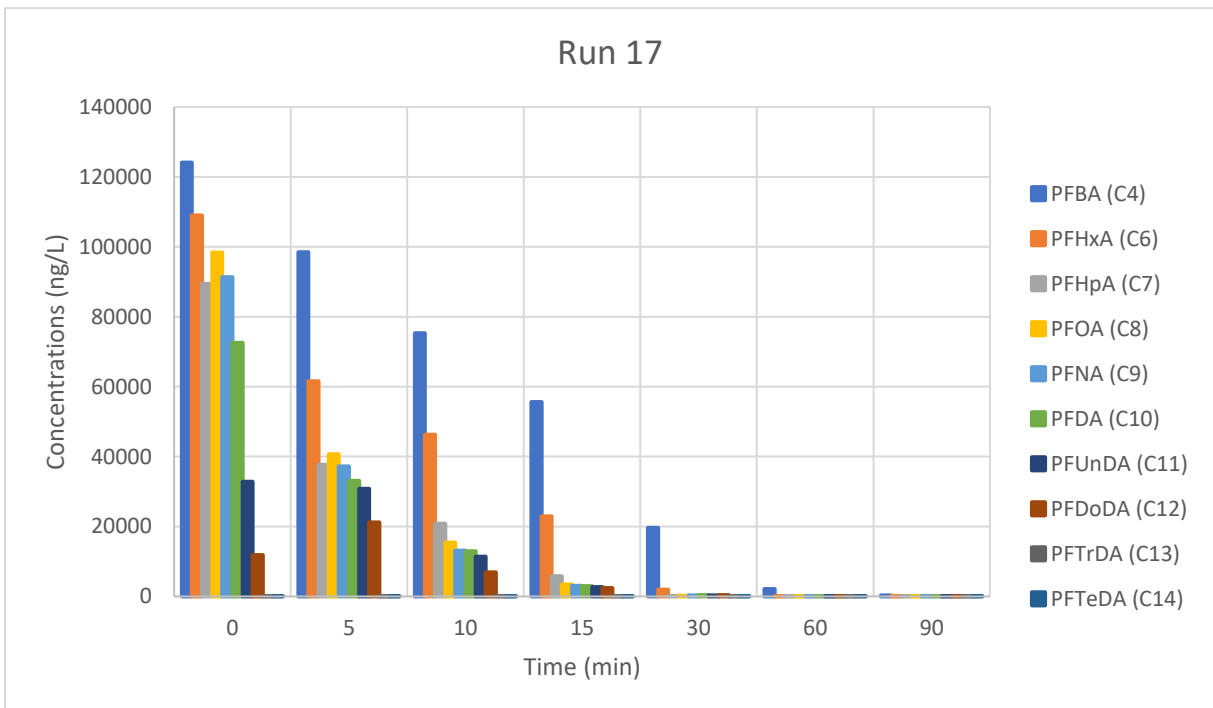

**FIGURE 15 - GROUPED BAR CHART SHOWING CONCENTRATIONS IN NG/L OF THE DIFFERENT PFAS COMPOUNDS AND THEIR CHANGE OVER TIME.**

This seems to confirm the theory as described in chapter 2.2.3 “PFAS”. It shows indeed that there is an increase in the concentrations of the shorter chained PFAS, PFBA (C4) and PFHxA (C6). Compared to the middle length chained PFAS, PFOA (C8), PFNA (C9) and PFDA (C10) where there is a good even removal rate. Contrary to the literature, the longest chained PFAS in the runs, PFUnDA (C11) and PFDODA (C12) increases in concentration until 5 minutes in run 17, as shown in Table 15, and is less efficient than the short-chained long chain PFAS (C8-C11). This is more pronounced in runs where the total removal efficiencies were lower. This may indicate that PFAS oxidation products that should be continued to be defluorinated instead come together in the solution to form longer chained PFAS.

The concentration of PFTTrDA (C13) and PFTTeDA (C14) were also measured in the even though they weren’t added to the original PFAS stock. The concentrations of these are in the range of 1-200 ng/L. They decrease in concentration gradually and the concentrations can therefore likely be due to residuals in the LC-MS instrument and should therefore not be considered.

TABLE 15 - REMOVAL RATE FROM INITIAL CONCENTRATIONS FOR EACH PFAS FOR DIFFERENT SAMPLING TIMES.

	Removal rate from initial concentration										Sum PFAS (excl. PFPA)
	PFBA (C4)	PFHxA (C6)	PFHpA (C7)	PFOA (C8)	PFNA (C9)	PFDA (C10)	PFUnDA (C11)	PFDODA (C12)	PFTTrDA (C13)	PFTTeDA (C14)	
R17m5	20,63	43,52	57,86	58,64	59,28	54,36	6,09	-78,36	-43,26	-10,96	42,68
R17m10	39,29	57,56	76,72	84,30	85,61	82,21	65,18	41,63	56,91	71,87	67,87
R17m15	55,20	78,95	93,47	96,57	96,66	95,93	91,78	80,10	84,87	75,86	84,30
R17m30	84,19	98,19	99,86	99,82	99,67	99,48	99,16	96,36	91,83	75,36	96,30
R17m60	98,27	99,94	99,98	99,97	99,97	99,96	99,86	99,41	3,85	68,65	99,60
R17m90	99,77	99,95	99,96	99,93	99,93	99,91	99,85	99,40	91,73	62,56	99,88

#### 4.4. UV-VIS SPECTRAL MEASUREMENTS

There was done a statistical analysis on UV-VIS spectral measurements, shown in Appendix 3. – Statistical analysis of UV-VIS and Residual concentrations. It was found that there wasn’t a significant correlation between UV-VIS spectra and the sum of PFAS. This means that UV-VIS in this state is not applicable to use for the measurements of PFAS. Figure 16 shows the normalised spectra with the baseline corrected. Figure 17 shows the correlation loadings, where the sum of PFAS is shown to be outside the bound of significant correlation.

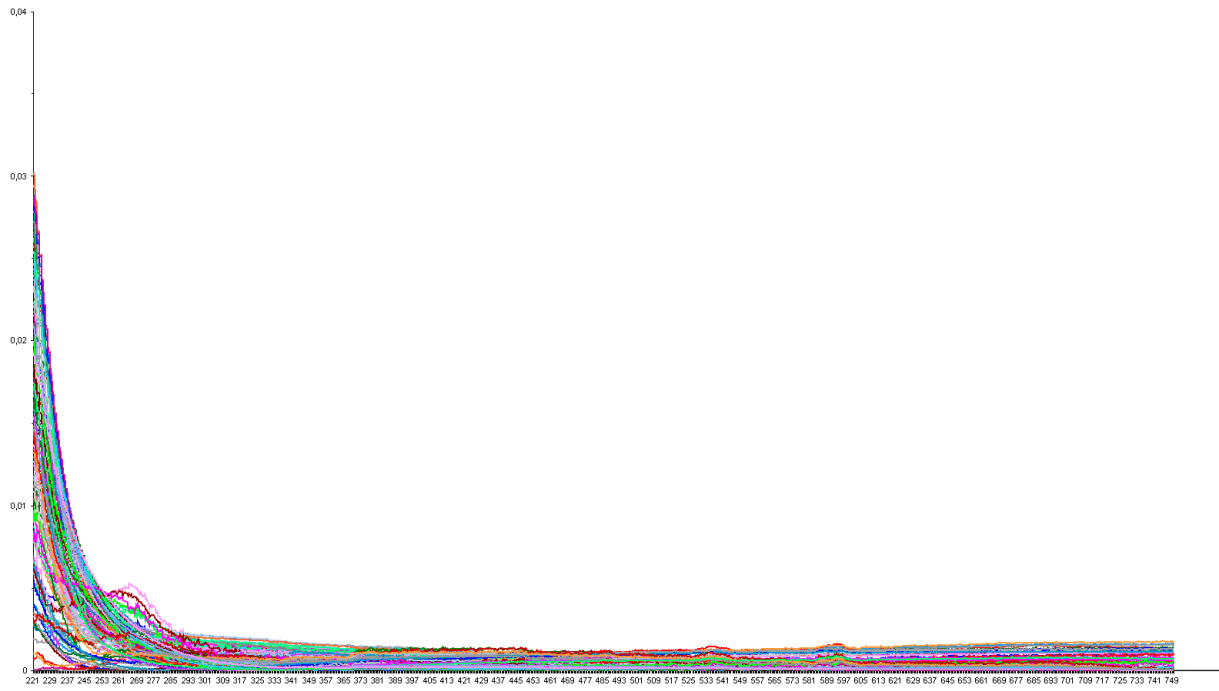

**FIGURE 16 – NORMALISED SPECTRA WITH THE BASELINE CORRECTED FOR ALL THE RUNS**

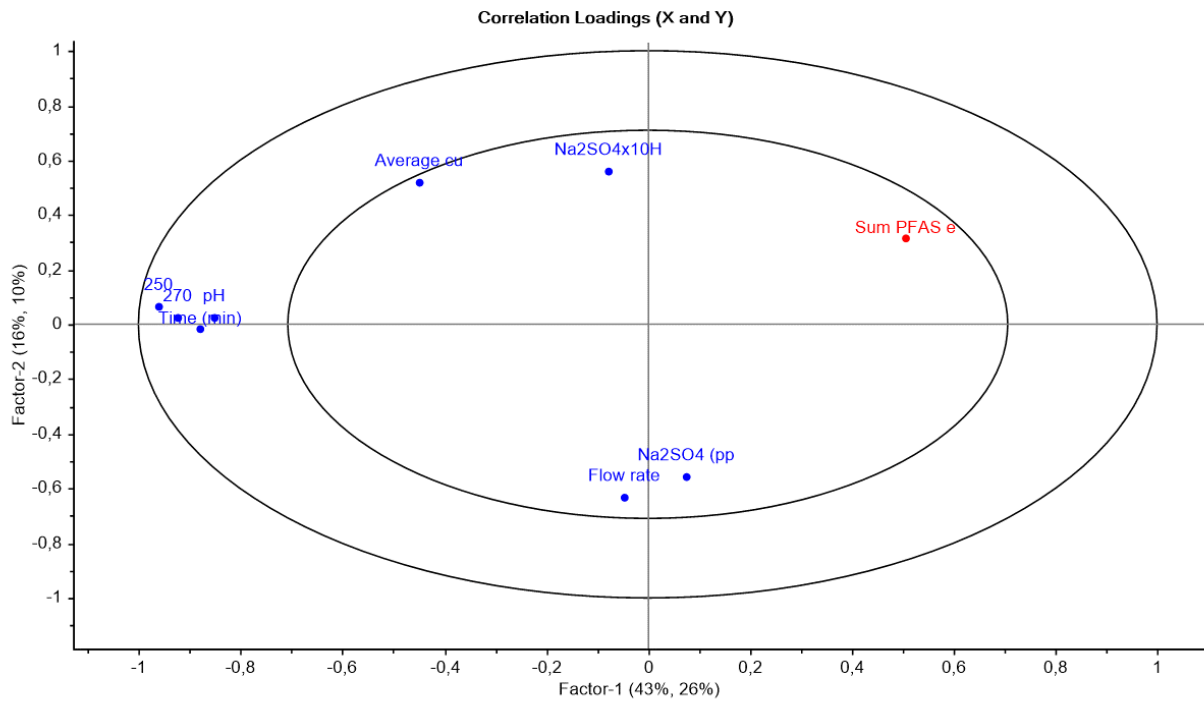

FIGURE 17 – CORRELATION LOADINGS FOR SUM OF PFAS AND WAVELENGTHS AT 250 AND 270 NM.

Figure 18 shows the spectral value of UV wavelength of 254 nm plotted against the residual PFAS concentrations. Where there are three outliers in the bottom right corner and the rest is grouped in the top left corner, with no correlation between the two axis. Figure 19 shows the UV254 plotted against the current density, which shows a considerable amount of scattering.



Correlation: -0,881  
 Color points by  
 Run  
 1 20

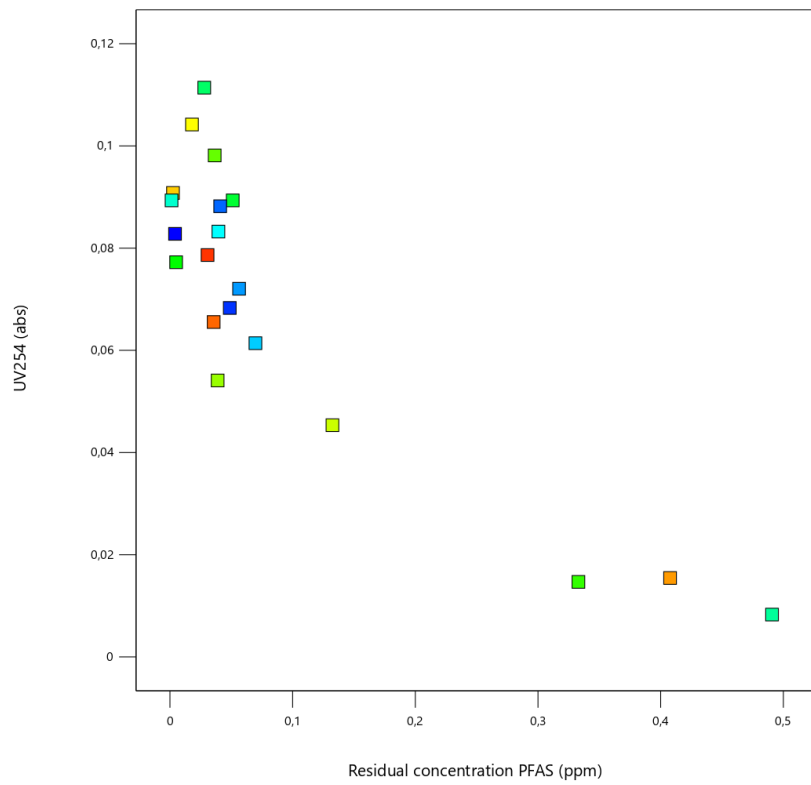

FIGURE 18 - UV254 PLOTTED AGAINST RESIDUAL PFAS CONCENTRATION.

Correlation: 0,726  
 Color points by  
 Run  
 1 20

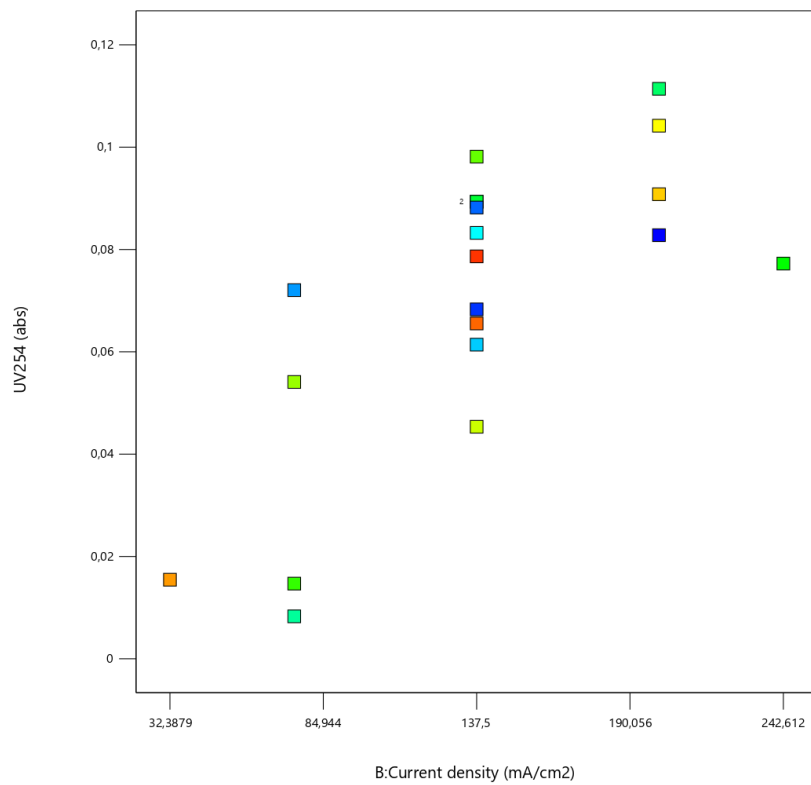

FIGURE 19 - UV254 PLOTTED AGAINST CURRENT DENSITY.

#### 4.5. FOAMING

All but two of the runs were foaming in the reservoir in varying degree (heavy, normal, and light), as seen in Figure 20. In run 17 it was forgotten to note whether there was any foaming. In run 8, the run with the minimum amount of PFAS, there was not any foaming which might be because of the low concentration. Depending on concentration and current density foaming was usually reduced to none before or around 30 minutes.

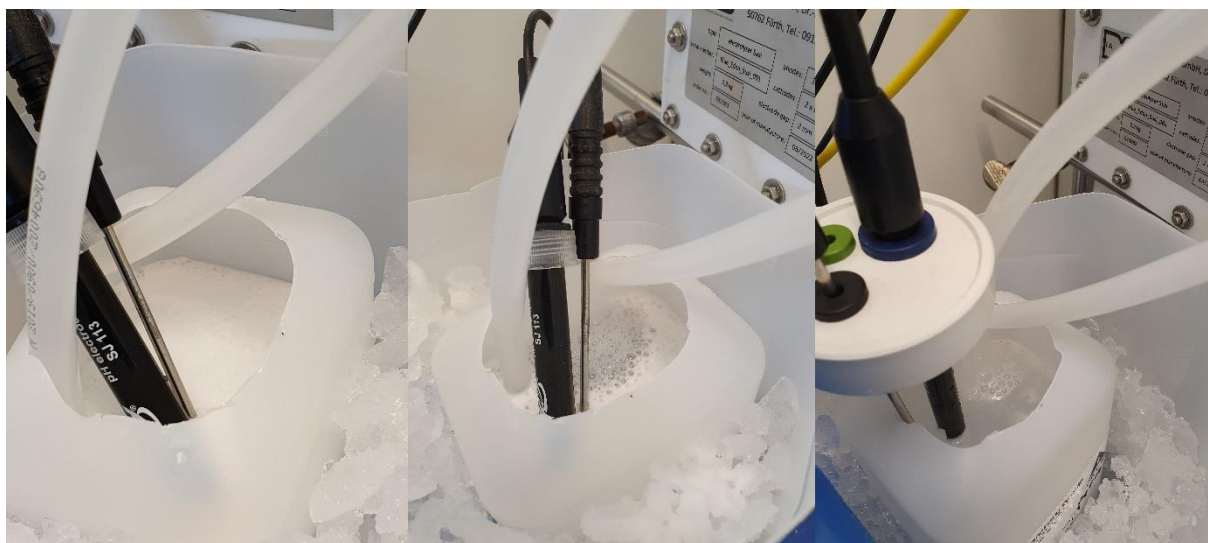

FIGURE 20 – FOAMING IN THE RESERVOIR FROM HEAVY TO LIGHT (LEFT TO RIGHT)

The foaming may be due to PFAS hydrophobic and hydrophilic nature aka surfactant, as suggested in an article (Shi et al., 2021), but is otherwise not noted much in literature except where foam fractioning is the goal of the study, where electrooxidation is not the means of foam fractioning. Shi et al. further suggests that the generation of foam promote encourage the separation of PFAS from the solution, especially the longer chained PFAS (C7-C10), which would cause the reservoir to have two phases with different concentrations. Foam was generated in solutions of  $>0,1 \mu\text{M}$  for each PFAS in a 250 mL solution with current densities  $>1 \text{ mA/cm}^2$  (Shi et al., 2021). Errors due to this are discussed in chapter 4.7 “sources of error”.

#### 4.6. pH

There is a trend in pH vs. EO-time. The pH varies depending on the variable parameters, initial PFAS concentration, flow through the reactor and current density. Still, they all follow a similar pattern; a sharp increase in pH followed by a valley, usually at the ten-minute mark with some

outliers where one of the parameters is set to one of the extremes, which is followed by a usually steady incline which reaches a highpoint at 90 minutes or a plateau from 60 minutes.

Figure 21 to Figure 24 show the pH for each run grouped in figures based on the CD.

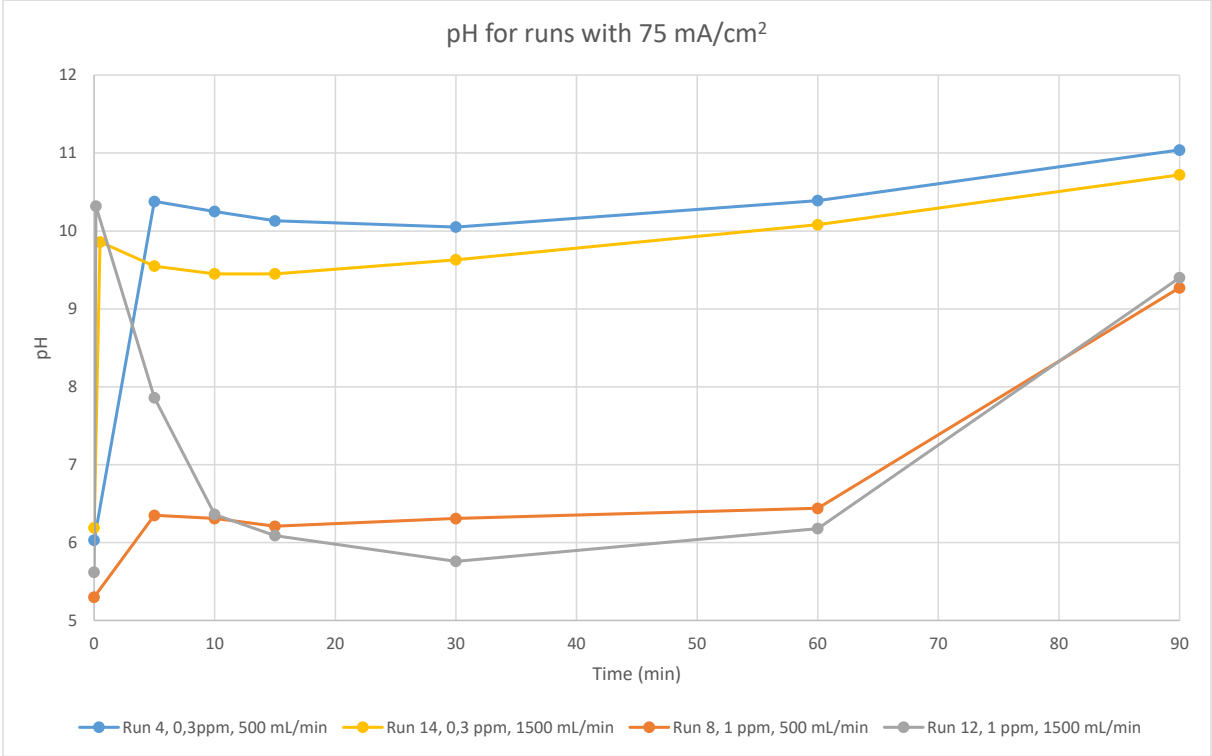

FIGURE 21 -PH MEASUREMENTS FOR RUNS WITH 75 MA/CM².

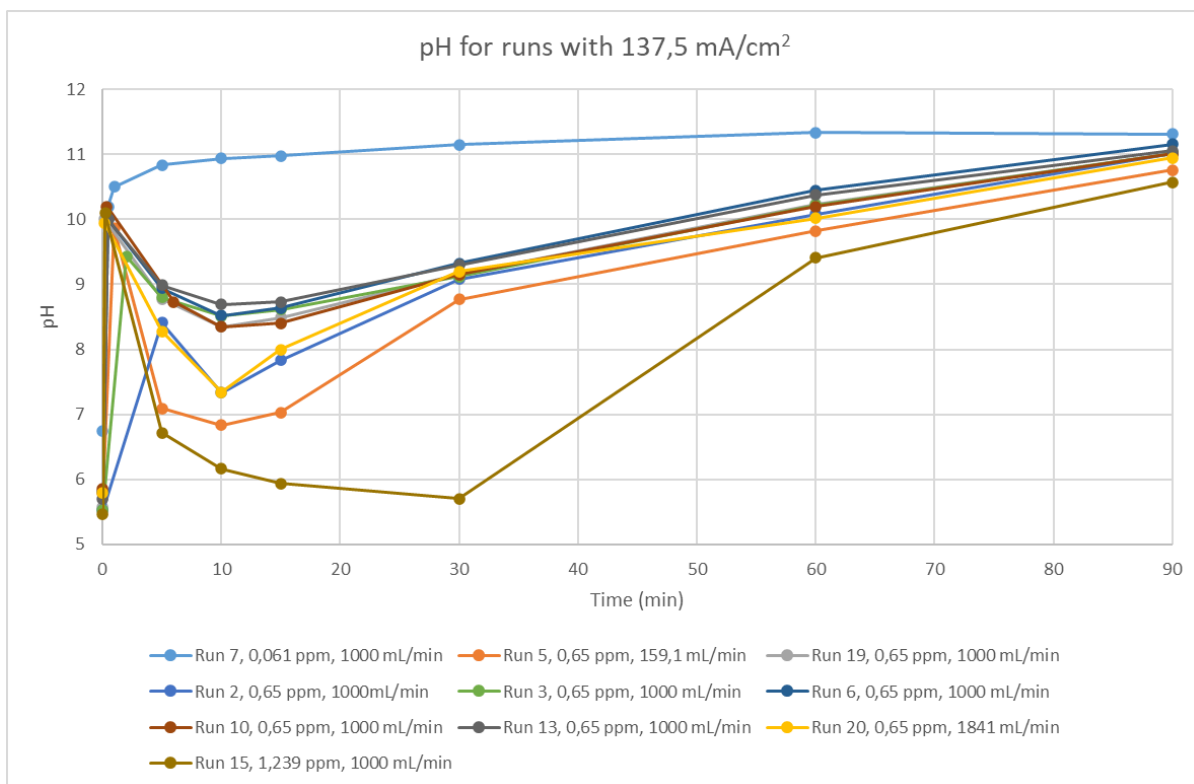

FIGURE 22 - PH MEASUREMENTS FOR RUNS WITH 137,5 MA/CM<sup>2</sup>.

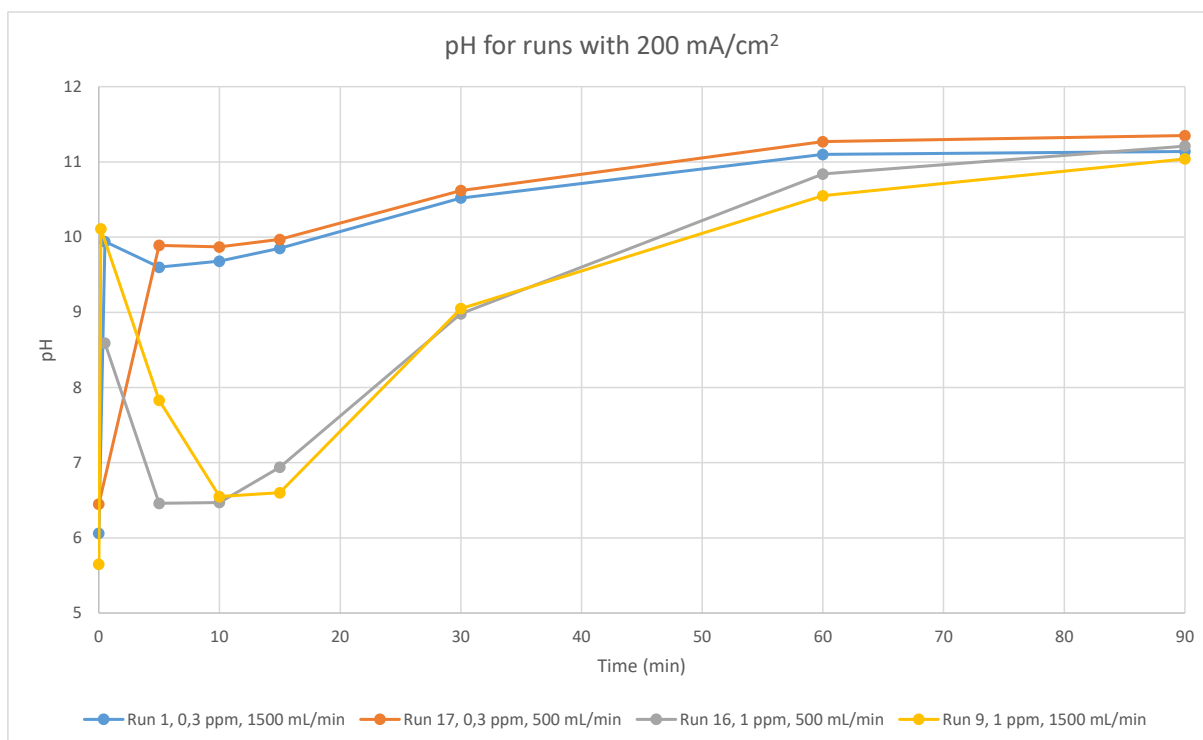

FIGURE 23 - PH MEASUREMENTS FOR RUNS WITH 200 MA/CM<sup>2</sup>.

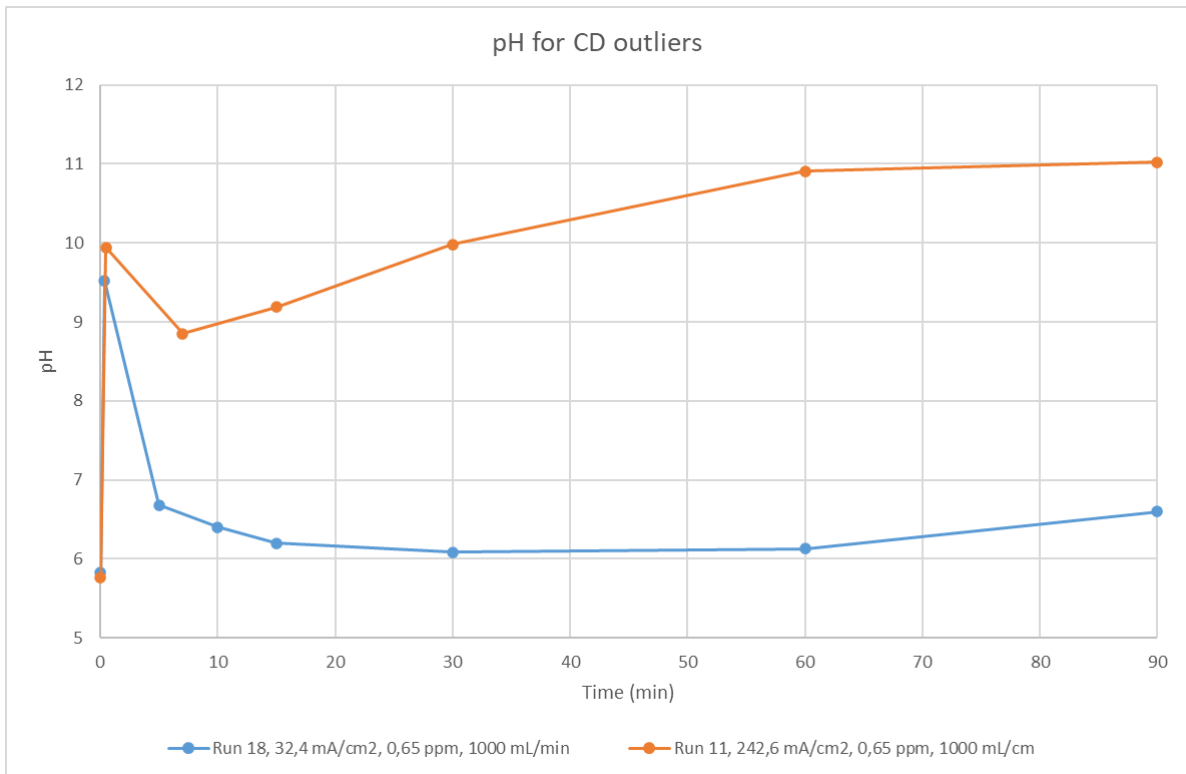

FIGURE 24 - PH MEASUREMENTS OVER TIME FOR RUNS WITH CD OUTLIERS

#### 4.7. SOURCES OF ERROR

PFPA (C5) was not in the calculated concentrations from the LC-MS, as stated in chapter 3.5. This means that the analysis doesn't show the complete picture when it comes to removal efficiency and the degradation chain of PFAS, as the step between the C6 and C4 is skipped in the analysis.

For the LC-MS, internal standards were not used. The runs were grouped together during analysis so the samples in the same run are comparable, but due to residuals in the instrument the different runs cannot be completely compared with one another.

There is a considerable difference in the theoretical and measured initial concentrations, Figure 25 shows this. This might be due to internal standards in LC-MS not being present or error in the production of PFAS stock solution.

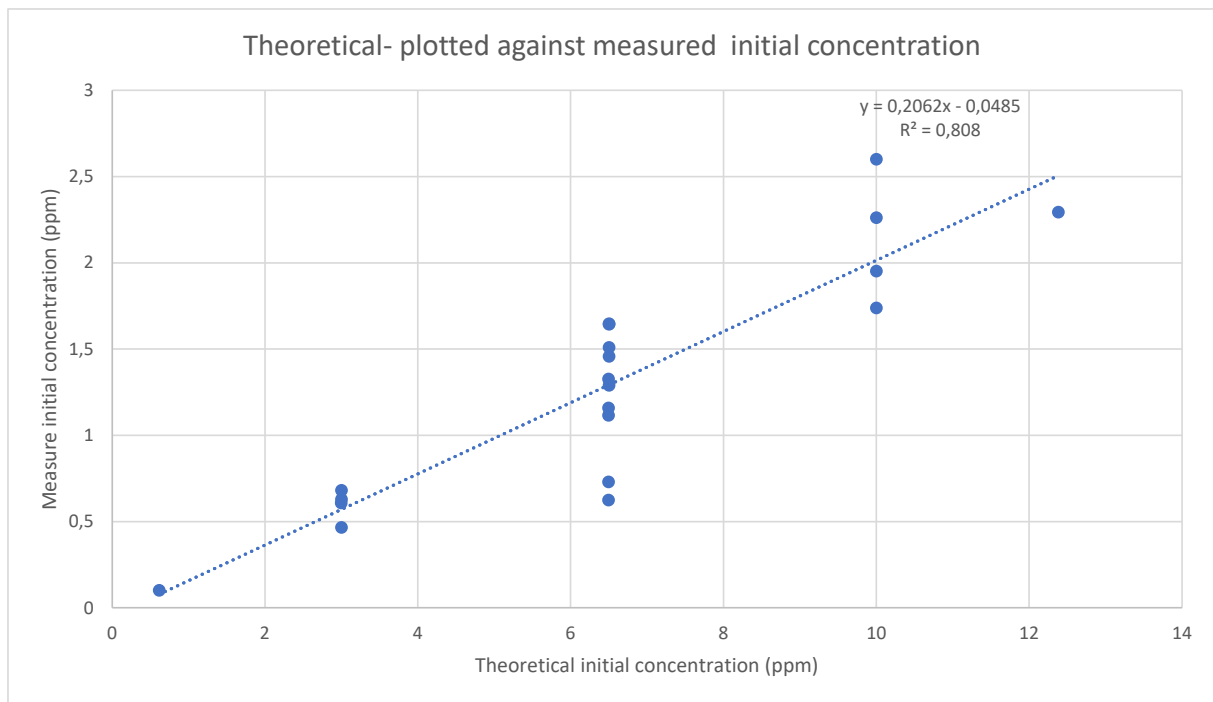

FIGURE 25 - THEORETICAL- PLOTTED AGAINST MEASURED INITIAL CONCENTRATION.

## 5. CONCLUSION

The electrochemical oxidation of PFAS is very promising. Most of the electrooxidation runs achieved more than 90% of removal efficiency. The best results were obtained with run 17 [Q; 0,5 L/min, CD: 200 mA/cm<sup>2</sup>, C: 0,629 ppm], achieving removal efficiencies of 67 %, 84% and 99,88% for samples taken 10, 15 and 90 minutes for the final removal efficiency.

For the optimal removal efficiencies, it seems to be more efficient to use higher current densities and lower PFAS concentrations. There is no correlation between the flowrate and residual PFAS concentration. It could be interesting to test higher flowrates than ones used in this set of experiments, as the reactor is able to do higher flowrates (>2,5 L/min).

There is no correlation between the UV-VIS absorbance of wavelengths UV spectra and the sum of PFAS. To be able to detect PFAS there may be a need to research other indirect measurements techniques e.g., fluorescence.

## LITERATURE

- AWWA. (2019). *Per- and Polyfluoroalkyl Substance (PFAS) - Overview and prevalence*. American Water Works Association. [https://www.awwa.org/Portals/0/AWWA/ETS/Resources/Per-andPolyfluoroalkylSubstances\(PFAS\)-OverviewandPrevalence.pdf?ver=2019-08-14-090234-873](https://www.awwa.org/Portals/0/AWWA/ETS/Resources/Per-andPolyfluoroalkylSubstances(PFAS)-OverviewandPrevalence.pdf?ver=2019-08-14-090234-873)
- Blytt, L. D., & Stang, P. (2018). *Organiske miljøgifter i norsk avløpsslam – Resultater fra undersøkelsen i 2017/18* (242/2018).
- Bomo, A.-M., & Schade, M. (2015). Vannforbruk i husholdninger: En erfaringsinnhenting. *VANN*, 50(2), 174-182. [https://vannforeningen.no/wp-content/uploads/2015/06/2015\\_929348.pdf](https://vannforeningen.no/wp-content/uploads/2015/06/2015_929348.pdf)
- Chen, R., Nie, Y., Kato, H., Wu, J., Utashiro, T., Lu, J., Yue, S., Jiang, H., Zhang, L., & Li, Y.-Y. (2017). Methanogenic degradation of toilet-paper cellulose upon sewage treatment in an anaerobic membrane bioreactor at room temperature. *Bioresource Technology*, 228, 69-76. <https://doi.org/https://doi.org/10.1016/j.biortech.2016.12.089>
- Clematis, D., & Panizza, M. (2021). Application of boron-doped diamond electrodes for electrochemical oxidation of real wastewaters. *Current Opinion in Electrochemistry*, 30, 100844. <https://doi.org/https://doi.org/10.1016/j.coelec.2021.100844>
- Dass, C. (2007). Hyphenated Separation Techniques. In *Fundamentals of Contemporary Mass Spectrometry* (pp. 151-194). <https://doi.org/https://doi.org/10.1002/9780470118498.ch5>
- De Luna, Y., & Bensalah, N. (2022). Review on the electrochemical oxidation of endocrine-disrupting chemicals using BDD anodes. *Current Opinion in Electrochemistry*, 32, 100900. <https://doi.org/https://doi.org/10.1016/j.coelec.2021.100900>
- DiaCCon GmbH. (2019). *Instruction manual: Electrolyser* [Instruction manual]. D. GmbH.
- DIRECTIVE (EU) 2020/2184 OF THE EUROPEAN PARLIAMENT AND OF THE COUNCIL of 16 December 2020 on the quality of water intended for human consumption, (2020). <https://eur-lex.europa.eu/legal-content/EN/TXT/PDF/?uri=CELEX:32020L2184&from=EN>
- Duinslaeger, N., & Radjenovic, J. (2022). Electrochemical degradation of per- and polyfluoroalkyl substances (PFAS) using low-cost graphene sponge electrodes. *Water Research*, 213, 118148. <https://doi.org/https://doi.org/10.1016/j.watres.2022.118148>
- ECHA. (2021, 23.02.2022). *Registry of restriction intentions until outcome: Per- and polyfluoroalkyl substances (PFAS)*. European Chemical Agency. <https://echa.europa.eu/da/registry-of-restriction-intentions/-/dislist/details/0b0236e18663449b>
- ECHA. (2022). *Perfluoroalkyl chemicals (PFAS)*. European Chemical Agency. Retrieved 18.04.22 from <https://echa.europa.eu/hot-topics/perfluoroalkyl-chemicals-pfas>
- Lov om endringer i naturmangfoldloven (hjemmel for gjennomføring av vanndirektivet), (2018). <https://lovdata.no/dokument/LTI/lov/2018-12-14-94>
- Enva. (2022). *Treating Fat, Oil and Grease in Wastewater* Enva. Retrieved 06.05.2022 from <https://enva.com/case-studies/fog-treatment-wastewater>
- European Commission. (2022a). *The EU Water Framework Directive - integrated river basin management for Europe*. European Commission. Retrieved 10.03.2022 from [https://ec.europa.eu/environment/water/water-framework/index\\_en.html](https://ec.europa.eu/environment/water/water-framework/index_en.html)
- European Commission. (2022b). *Introduction to the EU Water Framework Directive*. European Commission. Retrieved 10.03.2022 from [https://ec.europa.eu/environment/water/water-framework/info/intro\\_en.htm](https://ec.europa.eu/environment/water/water-framework/info/intro_en.htm)
- European Commission. (2022c). *Pesticides*. Directorate-General for Health and Food Safety. Retrieved 07.05.22 from [https://ec.europa.eu/food/plants/pesticides\\_en](https://ec.europa.eu/food/plants/pesticides_en)
- Garg, S., Wang, J., Kumar, P., Mishra, V., Arafat, H., Sharma, R. S., & Dumée, L. F. (2021). Remediation of water from per-/poly-fluoroalkyl substances (PFAS) – Challenges and perspectives. *Journal of Environmental Chemical Engineering*, 9(4), 105784. <https://doi.org/https://doi.org/10.1016/j.jece.2021.105784>
- Grung, M., Bæk, K., Rundberget, T., Halvorsen, H. J., & Tryland, I. (2022). *PFAS i råvann og drikkevann fra Norge* (268/2022).
- Hamid, H., & Li, L. (2016). Role of wastewater treatment plant in environmental cycling of poly- and perfluoroalkyl substances. *Ecocycles*, 2(2), 43-53. <https://doi.org/10.19040/ecocycles.v2i2.62>
- Haug, L. S., Knutsen, H. K., & Thomsen, C. (2018, 17.09.2020). *Fakta om PFAS*. Folkehelseinstituttet. <https://www.fhi.no/ml/miljo/miljogifter/fakta/fakta-om-pfos-og-pfoa/>



- Karim, A. V., Nidheesh, P. V., & Oturan, M. A. (2021). Boron-doped diamond electrodes for the mineralization of organic pollutants in the real wastewater. *Current Opinion in Electrochemistry*, 30, 100855. <https://doi.org/https://doi.org/10.1016/j.coelec.2021.100855>
- Forskrift om begrensning av forurensning, (2004). [https://lovdata.no/dokument/SF/forskrift/2004-06-01-931/KAPITTEL\\_4#KAPITTEL\\_4](https://lovdata.no/dokument/SF/forskrift/2004-06-01-931/KAPITTEL_4#KAPITTEL_4)
- Ksibi, M. (2006). Chemical oxidation with hydrogen peroxide for domestic wastewater treatment. *Chemical Engineering Journal*, 119(2), 161-165. <https://doi.org/https://doi.org/10.1016/j.cej.2006.03.022>
- Lenntech. (2022). *Hydrogen Peroxide*. Lenntech B.V. Retrieved 15.05.22 from <https://www.lenntech.com/library/oxidation/h2o2/hydrogen-peroxide.htm>
- Lim, S., Shi, J. L., von Gunten, U., & McCurry, D. L. (2022). Ozonation of organic compounds in water and wastewater: A critical review. *Water Research*, 213, 118053. <https://doi.org/https://doi.org/10.1016/j.watres.2022.118053>
- Ma, D., Yi, H., Lai, C., Liu, X., Huo, X., An, Z., Li, L., Fu, Y., Li, B., Zhang, M., Qin, L., Liu, S., & Yang, L. (2021). Critical review of advanced oxidation processes in organic wastewater treatment. *Chemosphere*, 275, 130104. <https://doi.org/https://doi.org/10.1016/j.chemosphere.2021.130104>
- McBeath, S. T., Serrano Mora, A., Asadi Zeidabadi, F., Mayer, B. K., McNamara, P., Mohseni, M., Hoffmann, M. R., & Graham, N. J. D. (2021). Progress and prospect of anodic oxidation for the remediation of perfluoroalkyl and polyfluoroalkyl substances in water and wastewater using diamond electrodes. *Current Opinion in Electrochemistry*, 30, 100865. <https://doi.org/https://doi.org/10.1016/j.coelec.2021.100865>
- METCALF & EDDY, & AECOM. (2014). *Wastewater Engineering: Treatment and Resource Recovery* (ISE 5 ed.). McGraw Hill Education.
- Miljødirektoratet. (2019). *Skjerpning av praksis for krav til sekundærrensing innenfor normalt og følsomt område*. Retrieved from [https://www.vannportalen.no/aktuelt/2019/miljodirektoratets-sektoransvar-for-vannmiljo---viktige-signaler-i-2019-og-2020/? t\\_id=Vo6llle6R5BJ48tzWklkVzge%3d%3d& t\\_uuid=4agutMJTQ9G%2fMIOCD7Ta9w& t\\_q=20.08.19& t\\_tags=language%3ano%2csiteid%3a3fe17408-2bcc-45f8-86af-9820a42b8e53%2candquerymatch& t\\_hit.id=Miljodirektoratet Vannportalen Features News Pages VannportalenNewsArticlePage/ 886c92d4-51cc-4887-9bb2-e89f322cb025 no& t\\_hit.pos=2](https://www.vannportalen.no/aktuelt/2019/miljodirektoratets-sektoransvar-for-vannmiljo---viktige-signaler-i-2019-og-2020/? t_id=Vo6llle6R5BJ48tzWklkVzge%3d%3d& t_uuid=4agutMJTQ9G%2fMIOCD7Ta9w& t_q=20.08.19& t_tags=language%3ano%2csiteid%3a3fe17408-2bcc-45f8-86af-9820a42b8e53%2candquerymatch& t_hit.id=Miljodirektoratet Vannportalen Features News Pages VannportalenNewsArticlePage/ 886c92d4-51cc-4887-9bb2-e89f322cb025 no& t_hit.pos=2)
- Miljødirektoratet. (2022). *Den norske prioritetslista*. Miljødirektoratet. Retrieved 08.05.22 from <https://www.miljodirektoratet.no/ansvarsomrader/kjemikalier/prioritetslista/>
- Moher, D., Liberati, A., Tetzlaff, J., Altman, D. G., & The, P. G. (2009). Preferred Reporting Items for Systematic Reviews and Meta-Analyses: The PRISMA Statement. *PLOS Medicine*, 6(7), e1000097. <https://doi.org/10.1371/journal.pmed.1000097>
- Phong Vo, H. N., Ngo, H. H., Guo, W., Hong Nguyen, T. M., Li, J., Liang, H., Deng, L., Chen, Z., & Hang Nguyen, T. A. (2020). Poly-and perfluoroalkyl substances in water and wastewater: A comprehensive review from sources to remediation. *Journal of Water Process Engineering*, 36, 101393. <https://doi.org/https://doi.org/10.1016/j.jwpe.2020.101393>
- Pluciennik-Koropczuk, E., & Myszograj, S. (2019). New Approach in COD Fractionation Methods. *Water*, 11(7). <https://doi.org/10.3390/w11071484>
- DIRECTIVE 2013/39/EU OF THE EUROPEAN PARLIAMENT AND OF THE COUNCIL of 12 August 2013 amending Directives 2000/60/EC and 2008/105/EC as regards priority substances in the field of water policy, (2013). <https://eur-lex.europa.eu/legal-content/EN/TXT/PDF/?uri=CELEX:32013L0039&from=EN>
- Rusten, B., & Lidholm, O. (2017). *Skisseprosjekt for utvidelse av Gardermoen renseanlegg - Delprosjekt 1 med reviderte prognoser for kommunal vekst* (17-017). <https://www.statsforvalteren.no/contentassets/cb3fbd2e8fa64393a31b59db1dcd73f6/revidert-skisseprosjekt-gra---delrapp-1.pdf>
- SEKRENS. *Prosjektbeskrivelse for Regionalt innovasjonsprosjekt - SEKRENS*. Regionale forskningsfond.
- Shi, H., Chiang, S.-Y., Wang, Y., Wang, Y., Liang, S., Zhou, J., Fontanez, R., Gao, S., & Huang, Q. (2021). An electrocoagulation and electrooxidation treatment train to remove and degrade per- and polyfluoroalkyl substances in aqueous solution. *Science of The Total Environment*, 788, 147723. <https://doi.org/https://doi.org/10.1016/j.scitotenv.2021.147723>
- Shon, H. K., Vigneswaran, S., & Snyder, S. A. (2006). Effluent Organic Matter (EfOM) in Wastewater: Constituents, Effects, and Treatment. *Critical Reviews in Environmental Science and Technology*, 36(4), 327-374. <https://doi.org/10.1080/10643380600580011>
- Sillanpää, M., & Shestakova, M. (2017). *Electrochemical Water Treatment Methods*. Elsevier.
- Søndre Follo Renseanlegg IKS. (2017). Renseprosess steg for steg. In: Søndre Follo Renseanlegg IKS.

- Søndre Follo Renseanlegg IKS. (2019). *Søndre Follo Renseanlegg IKS. Kort beskrivelse av Renseanlegget*. <http://sfrens.no/wp-content/uploads/2019/12/20190902-SFR-Beskrivelse-av-rensprosess.pdf>
- Thomas, O., & Burgess, C. (Eds.). (2017). *UV-Visible Spectrophotometry of Water and Wastewater* (2 ed.). Elsevier.
- Todt, D., Heistad, A., & Jenssen, P. D. (2015). Load and distribution of organic matter and nutrients in a separated household wastewater stream. *Environmental Technology*, 36(12), 1584-1593. <https://doi.org/10.1080/09593330.2014.997300>
- Torfs, E., Doucet, J., D, S., Hö, D., Gupta, M., Nakhla, G., & Vanrolleghem, P. (2017). Characterization of cellulose biodegradation kinetics in wastewater in view of increasing a WRRF's capacity by a pre-treatment sieve step. *Proceedings of the Water Environment Federation*, 2017, 4255-4262. <https://doi.org/10.2175/193864717822156055>
- United Nations - Department of Economic and Social Affairs. (2021). *The Sustainable Development Goals Report 2021* (ISBN: 978-92-1-101439-6). <https://unstats.un.org/sdgs/report/2021/The-Sustainable-Development-Goals-Report-2021.pdf>
- United Nations - Department of Economic and Social Affairs. (2022a). *6 - Ensure availability and sustainable management of water and sanitation for all*. United Nations. Retrieved 03.03.2022 from <https://sdgs.un.org/goals/goal6>
- United Nations - Department of Economic and Social Affairs. (2022b). *The 17 Goals | Sustainable Development*. United Nations. Retrieved 03.03.2022 from <https://sdgs.un.org/goals>
- United Nations - Department of Economic and Social Affairs. (2022c). *Water and Sanitation*. United Nations. Retrieved 03.03.2022 from <https://sdgs.un.org/topics/water-and-sanitation>
- Vaezi, F., Naddafi, K., & Alimohammadi, M. (2004). Application of chlorine dioxide for secondary effluent polishing. *International Journal of Environment Science and Technology (ISSN: 1735-1472) Vol 1 Num 2, 1*. <https://doi.org/10.1007/BF03325821>
- Veciana, M., Bräunig, J., Farhat, A., Pype, M.-L., Freguia, S., Carvalho, G., Keller, J., & Ledezma, P. (2022). Electrochemical oxidation processes for PFAS removal from contaminated water and wastewater: fundamentals, gaps and opportunities towards practical implementation. *Journal of Hazardous Materials*, 434, 128886. <https://doi.org/https://doi.org/10.1016/j.jhazmat.2022.128886>
- Directive 2000/60/EC of the European Parliament and of the Council establishing a framework for the Community action in the field of water policy, (2000). <https://eur-lex.europa.eu/legal-content/EN/TXT/PDF/?uri=CELEX:32020L2184&from=EN>
- WHO. (2012). *Pharmaceuticals in drinking-water*. <https://apps.who.int/iris/rest/bitstreams/96066/retrieve>
- Wu, W., Bai, L., Liu, X., Tang, Z., & Gu, Z. (2011). Nanograss array boron-doped diamond electrode for enhanced electron transfer from *Shewanella loihica* PV-4. *Electrochemistry Communications*, 13(8), 872-874. <https://doi.org/https://doi.org/10.1016/j.elecom.2011.05.025>
- Yasri, N., & Gunasekaran, S. (2017). Electrochemical Technologies for Environmental Remediation. In (pp. 5-73). [https://doi.org/10.1007/978-3-319-55423-5\\_2](https://doi.org/10.1007/978-3-319-55423-5_2)
- Zhou, M., Oturan, M., & Sires, I. (2017). *Electro-Fenton Process: New Trends and Scale-Up*.
- Ødegaard, H. (Ed.). (2014). *Vann- og avløpsteknikk* (2 ed.). Norsk Vann.
- Ødegaard, H., & Skrøvseth, A. F. (1997). An evaluation of performance and process stability of different processes for small wastewater treatment plants. *Water Science and Technology*, 35(6), 119-127. <https://doi.org/10.2166/wst.1997.0250>

## APPENDIX 1. – CONCENTRATIONS RUN 1-20(ng/L)

Run/sample	PFBA (C4) (ng/L)	PFHxA (C6) (ng/L)	PFHpA (C7) (ng/L)	PFOA (C8) (ng/L)	PFNA (C9) (ng/L)	PFDA (C10) (ng/L)	PFUnDA (C11) (ng/L)	PFDaDA (C12) (ng/L)	PFTTrDA (C13) (ng/L)	PFTeDA (C14) (ng/L)	Sum PFAS (excl. PFPA) (ng/L)
R1m0	125353,1	113333,7	88439,5	94440,4	88394,7	64336,3	24106,0	8637,5	168,9	872,6	608082,7
R1m5	106331,5	86299,8	58079,0	50301,5	44376,6	46739,4	37424,3	17125,2	170,9	888,9	447737,2
R1m10	79095,6	56326,2	28859,8	20276,1	15596,2	19922,1	18950,6	10039,6	44,0	202,9	249313,2
R1m15	61413,7	31992,2	11115,1	5689,2	3756,8	6286,7	8041,6	5729,3	48,5	206,2	134279,4
R1m30	25190,2	3616,6	413,3	397,8	406,1	584,4	902,8	863,4	40,5	195,9	32611,0
R1m60	3140,6	205,1	92,3	91,7	68,8	93,2	89,6	182,7	35,2	188,7	4188,0
R1m90	501,8	152,9	81,9	86,3	58,8	58,6	48,3	93,6	34,5	210,5	1327,2
R2m0	306773,4	290762,9	229208,9	255034,6	243608,4	188964,1	91220,3	37365,1	253,5	784,3	1643975,5
R2m5	276064,0	243206,4	194133,5	224552,1	255549,1	229993,0	131533,4	48134,2	288,6	856,6	1604311,0
R2m10	215153,1	204336,6	153206,6	172712,7	207800,0	216629,4	129876,6	38797,4	110,9	162,7	1338786,1
R2m15	190836,6	164672,9	114038,9	112996,7	117590,4	120513,1	79005,9	41635,8	124,3	198,2	941612,7
R2m30	122143,3	68673,2	30369,1	19364,7	15373,0	23046,5	30425,8	23250,1	72,5	174,2	332892,4
R2m60	38145,9	5472,6	610,4	433,1	502,9	963,3	1158,9	1295,7	36,4	157,4	48776,6
R2m90	7197,3	233,5	120,6	128,8	90,6	117,8	161,7	313,7	33,2	162,5	8559,6
R3m0	305289,3	281687,7	230536,4	253946,4	232281,7	179629,0	100784,7	62124,6	302,8	682,8	1647265,5
R3m5	276384,8	246605,7	200793,0	253902,8	338725,4	373336,4	247178,7	102905,7	425,1	673,0	2040930,7
R3m10	217310,1	207870,9	160762,0	180871,9	198172,4	194013,8	110554,3	33283,3	79,2	121,8	1303039,6
R3m15	196871,8	172762,0	124439,5	136268,6	176928,2	221007,1	146691,8	42030,3	117,1	175,7	1217292,1
R3m30	133162,0	80442,9	40290,0	26409,3	20431,3	23573,4	27860,8	13764,7	63,3	147,0	366144,6
R3m60	34260,2	3840,6	312,6	247,2	221,3	385,6	576,1	951,4	41,0	129,9	40965,9
R3m90	6358,9	272,0	116,0	110,7	68,2	105,5	128,5	233,6	38,4	125,1	7556,9
R4m0	127300,3	119376,7	97282,8	105587,7	102236,2	81871,6	36533,1	11081,6	114,8	428,9	681813,7
R4m5	119756,9	105740,3	83599,7	81203,2	71497,7	66417,5	56676,0	42296,5	172,7	422,0	627782,5
R4m10	103806,4	97556,5	72971,9	64696,2	50406,5	46622,5	37871,9	19373,7	41,5	85,6	493432,7
R4m15	96790,6	84081,8	59488,6	48923,6	36054,4	33759,4	29370,5	17004,6	40,2	100,6	405614,2
R4m30	74923,8	53203,0	29649,2	18410,2	11834,5	11515,8	10271,4	6587,0	24,0	96,0	216514,9

R4m60	36637,9	11473,1	2053,1	927,0	783,4	1034,8	1675,6	1649,5	22,1	98,6	56355,2
R4m90	13966,6	1294,2	89,0	85,9	62,4	89,2	305,3	509,8	17,7	102,3	16522,5
R5m0	283318,4	251470,3	198662,5	213412,7	173117,6	118378,4	57933,2	29422,6	123,3	380,5	1326219,4
R5m5	255572,9	206650,5	162918,7	188409,6	184776,1	133628,9	77980,9	33681,7	131,0	362,1	1244112,5
R5m10	206884,1	179130,0	133143,0	158763,2	163178,4	135722,4	87404,6	33533,2	84,8	87,3	1097931,0
R5m15	187311,9	146436,3	101229,9	118532,2	128671,1	122489,0	66195,1	28209,7	66,5	90,0	899231,6
R5m30	134046,1	73657,4	36919,1	40417,8	42407,8	45902,4	30462,5	11596,0	29,2	82,4	415520,6
R5m60	52021,7	9958,8	1626,8	1005,9	867,6	1175,0	1461,2	1518,2	13,4	67,1	69715,7
R5m90	14800,5	1090,2	289,3	270,0	257,4	416,0	486,2	413,1	12,7	69,7	18105,1
R6m0	292239,2	274596,9	213440,4	226320,2	201239,4	145395,7	66098,0	37431,0	113,9	320,9	1457195,6
R6m5	262088,1	231681,2	186842,2	225925,5	261068,7	217030,5	112776,9	41648,8	94,2	321,2	1539477,4
R6m10	207795,3	195284,2	148676,1	173793,8	202376,5	195850,8	117361,2	50858,2	114,9	92,2	1292203,2
R6m15	185545,4	158243,8	111725,9	119992,7	137898,6	156354,1	101512,6	39392,0	88,7	97,0	1010851,0
R6m30	124172,3	71405,0	33476,5	23385,6	18876,2	23641,7	27820,5	12816,5	26,2	67,2	335687,7
R6m60	32927,5	3592,4	364,8	296,9	239,4	397,3	742,4	873,4	9,8	69,5	39513,4
R6m90	6179,3	304,7	123,7	99,7	57,7	61,2	108,9	215,0	10,8	58,3	7219,3
R7m0	17839,5	18865,0	15528,1	17076,8	15931,2	10848,5	3512,7	930,4	65,7	254,4	100852,3
R7m5	15746,0	13232,1	8668,7	8431,7	8024,1	7818,0	5697,7	3756,7	57,7	266,1	71698,9
R7m10	11975,9	8644,3	4058,4	3496,0	3220,5	3823,5	3183,7	1982,8	22,4	49,3	40456,9
R7m15	9648,3	4860,7	1494,2	988,9	805,2	1144,0	984,0	676,0	11,1	53,8	20666,0
R7m30	4534,3	832,3	110,2	90,0	52,1	100,0	114,3	137,9	18,2	56,1	6045,4
R7m60	970,2	116,8	48,4	38,2	18,2	24,7	29,3	36,0	11,5	52,5	1345,9
R7m90	264,0	111,3	65,9	51,6	21,0	26,1	27,7	24,8	10,0	61,6	664,0
R8m0	464259,0	432489,0	353183,9	372119,1	359536,9	308245,4	190709,5	119036,2	331,4	294,3	2600204,6
R8m5	445472,9	392218,9	316504,8	365446,7	398407,8	289885,8	169386,9	70998,7	123,0	296,2	2448741,7
R8m10	339280,4	355391,8	283135,4	296038,4	267056,8	206523,8	126653,9	33752,6	57,6	54,2	1907944,9
R8m15	324087,8	327339,1	255797,7	279354,8	331283,9	322460,1	210564,2	44667,6	90,3	60,2	2095705,7
R8m30	271516,9	240136,9	168146,5	162984,6	169699,6	183726,3	128096,2	37931,7	54,2	59,2	1362352,2
R8m60	183634,6	119355,0	63614,5	38352,4	25675,1	27641,5	23263,9	9196,8	21,8	42,5	490798,0
R8m90	109712,5	46157,9	15255,6	6631,9	4508,8	6996,1	8868,5	6069,5	21,7	46,3	204268,8
R9m0	432791,5	352983,7	276434,2	291417,0	258437,0	193070,3	95991,5	50292,1	143,1	253,4	1951813,9

R9m5	390140,2	322053,3	261080,0	321149,3	318414,7	249144,5	142991,4	49198,0	116,9	282,3	2054570,6
R9m10	284418,8	255595,4	194164,8	230985,4	247452,9	194560,7	118887,3	40649,8	78,3	64,4	1566857,7
R9m15	246884,1	190703,0	131585,1	154508,8	193713,1	178001,7	105822,7	39041,6	75,4	79,0	1240414,6
R9m30	147145,7	65997,0	25945,5	18352,3	19786,7	29060,7	24249,8	8452,5	17,6	48,9	339056,7
R9m60	24829,3	1438,4	232,8	192,6	207,7	330,5	364,5	364,0	6,4	40,7	28006,9
R9m90	3395,8	467,7	177,8	134,6	102,9	124,9	96,3	63,4	5,8	39,1	4608,3
R10m0	305965,9	253675,9	216789,5	245504,0	220375,4	155975,0	74675,4	36935,8	128,9	235,7	1510261,7
R10m5	287232,8	242906,3	200175,6	274815,1	311129,6	227833,8	125731,2	42467,8	89,4	228,6	1712610,3
R10m10	217050,3	181515,9	133933,0	158526,0	171333,4	156252,9	82041,7	27522,4	50,1	55,8	1128281,7
R10m15	201917,7	169823,6	121917,8	144069,1	205506,8	232564,3	156571,7	55593,4	87,0	44,2	1288095,5
R10m30	139229,8	82382,7	43181,6	38185,2	45525,4	60981,4	47708,7	17203,2	30,8	49,2	474478,0
R10m60	41520,6	5401,2	561,3	364,4	380,3	705,1	1125,4	1074,2	11,6	39,6	51183,6
R10m90	7900,4	436,4	180,0	139,6	105,9	131,8	147,2	210,9	4,2	37,3	9293,7
R11m0	265935,5	130113,7	152764,2	191314,0	178278,8	126150,1	53233,9	18570,9	73,3	243,7	1116678,1
R11m5	184386,3	87006,7	77077,1	105281,6	149016,1	157328,9	93858,0	35778,0	82,5	208,3	890023,4
R11m10	160945,6	109749,2	58894,1	62050,8	92562,0	115375,9	80913,1	26191,5	40,5	46,2	706769,0
R11m15	124128,5	41598,2	22943,5	18508,3	27237,8	40260,4	36111,5	14284,3	20,1	42,7	325135,4
R11m30	41466,8	4982,3	467,1	298,1	270,4	600,5	1086,2	1138,1	11,2	39,4	50360,0
R11m60	3849,8	303,0	118,3	92,9	88,6	178,5	194,2	197,5	14,6	42,2	5079,8
R11m90	602,8	201,9	81,3	77,9	72,9	103,3	87,1	74,1	6,4	34,3	1341,9
R12m0	344181,7	258701,8	245720,2	292019,9	253254,1	179252,8	98793,6	66239,3	174,4	162,2	1738500,1
R12m5	377541,3	310680,3	260447,7	299827,6	235727,9	149437,8	88449,1	50343,5	98,2	163,7	1772717,0
R12m10	256948,4	195115,0	233451,9	298175,2	292934,2	234671,5	134738,5	52447,9	117,4	70,4	1698670,6
R12m15	243874,8	139726,6	183524,9	223033,4	202533,9	122354,5	65273,6	35011,1	79,1	67,0	1215478,9
R12m30	242275,8	103399,4	136230,9	141438,3	124180,3	94123,5	53110,7	21324,5	43,0	55,0	916181,5
R12m60	159042,3	73372,3	38996,0	20957,0	10149,0	13930,2	10402,4	6041,9	16,3	41,7	332948,9
R12m90	85366,4	18179,4	4739,6	1157,9	506,4	1457,0	2712,6	2290,3	9,9	30,9	116450,3
R13m0	237019,2	232604,0	177168,6	189789,0	171427,4	125705,6	74322,0	81500,9	192,1	117,6	1289846,4
R13m5	247092,4	206614,9	160927,0	207746,2	232951,8	170742,9	85602,4	34539,6	79,1	152,0	1346448,2
R13m10	195956,0	172723,4	125782,5	137332,2	130688,6	111220,2	52675,0	19405,5	30,2	35,8	945849,5
R13m15	175020,2	139234,2	95253,2	101366,3	115846,6	127917,8	77092,6	26899,4	48,6	34,9	858713,8

R13m30	115764,3	62110,2	26946,3	18553,0	15686,2	20577,3	25452,9	12650,7	20,1	37,1	297797,9
R13m60	30986,4	3028,9	306,8	275,4	202,7	334,2	641,5	704,0	10,9	17,3	36508,1
R13m90	5855,0	271,5	131,0	105,6	88,6	120,5	127,2	163,0	3,2	27,8	6893,3
R14m0	101518,8	53101,4	74372,2	81189,3	73442,9	50425,2	20422,6	11680,7	73,8	126,7	466353,5
R14m5	108074,7	88482,0	65581,9	63307,2	51146,0	47334,1	29413,7	11522,9	21,4	98,6	464982,5
R14m10	93887,6	76806,9	54108,9	43169,5	28738,6	28528,4	24389,4	9321,0	29,3	32,2	359011,9
R14m15	87575,2	64361,9	34763,1	24310,0	16646,7	16918,3	18437,4	7828,9	18,3	25,7	270885,5
R14m30	66329,5	34237,5	16382,1	7179,3	2739,7	3534,6	5975,1	4060,5	12,6	21,6	140472,6
R14m60	31166,4	5279,3	1058,3	372,8	175,6	200,2	340,5	282,9	8,7	22,5	38907,2
R14m90	12696,4	830,1	210,6	158,9	108,7	112,2	102,1	100,4	27,5	18,2	14365,0
R15m0	511324,6	407249,7	316123,9	335956,8	317901,6	244687,5	120134,4	40284,7	88,3	149,2	2293900,7
R15m5	472192,5	390632,4	319500,1	344463,4	357293,6	327254,1	199555,4	68678,6	175,9	131,4	2479877,3
R15m10	346261,8	335670,9	270169,6	339054,6	356731,8	339205,8	216579,5	63074,8	132,7	41,3	2266922,7
R15m15	316843,3	277285,1	224035,9	281860,4	257822,3	202633,0	115758,4	29506,8	45,7	31,5	1705822,4
R15m30	235003,8	155585,7	104285,0	123578,0	165060,9	151218,2	88075,8	23513,3	36,9	25,8	1046383,4
R15m60	92120,9	23173,3	5056,0	2229,4	1537,9	2707,8	3145,3	2484,8	23,7	19,5	132498,6
R15m90	20494,3	983,5	243,9	236,5	336,2	536,4	385,0	436,2	6,8	19,9	23678,7
R16m0	438307,0	389892,0	317616,1	349582,6	333588,6	270854,7	128397,3	32951,5	62,6	111,8	2261364,3
R16m5	386321,0	310726,9	233526,2	265008,0	256780,5	234641,5	155652,7	98226,4	204,1	158,3	1941245,7
R16m10	269916,8	227698,5	153945,7	158766,5	148919,5	133865,2	80615,9	25317,5	49,5	32,3	1199127,5
R16m15	230816,6	163194,3	99600,3	110339,3	131087,3	136716,3	92014,2	25236,6	35,2	14,7	989055,0
R16m30	124194,5	46495,4	14062,3	10158,8	12819,2	19231,2	19072,2	9302,0	9,6	19,3	255364,5
R16m60	15932,0	484,4	114,4	154,5	154,0	228,0	258,0	673,3	8,1	15,3	18022,0
R16m90	1791,8	81,6	41,8	50,1	43,7	62,6	153,0	835,4	7,2	17,3	3084,3
R17m0	124079,6	108979,2	89362,3	98384,5	91321,3	72516,0	32782,0	11878,2	52,9	71,3	629427,3
R17m5	98481,1	61555,0	37654,3	40687,1	37182,3	33098,8	30784,4	21186,0	75,7	79,1	360783,9
R17m10	75329,3	46249,3	20805,3	15445,4	13142,1	12898,8	11416,0	6933,2	22,8	20,0	202262,2
R17m15	55589,0	22938,3	5832,1	3376,6	3048,4	2954,7	2693,7	2363,8	8,0	17,2	98821,7
R17m30	19615,1	1967,6	123,3	179,1	301,4	374,5	273,8	432,1	4,3	17,6	23288,7
R17m60	2148,3	61,3	17,3	28,1	28,1	31,5	44,5	69,6	50,8	22,3	2501,8
R17m90	289,7	54,4	38,4	67,7	68,3	66,7	47,9	71,1	4,4	26,7	735,2

R18m0	261649,5	205155,3	158303,1	176081,3	160238,4	115499,9	54908,0	27313,1	64,3	85,2	1159298,2
R18m5	245199,8	205170,3	166934,5	199154,0	193573,0	135347,8	62613,5	23957,6	74,7	88,4	1232113,5
R18m10	211710,0	199235,1	160078,7	186090,7	168474,7	119046,2	58056,5	20227,8	43,4	25,5	1122988,7
R18m15	206271,1	187878,2	150208,9	172602,2	165121,0	111699,3	46041,6	19265,5	35,5	25,8	1059149,3
R18m30	184398,0	153067,0	115183,3	119100,7	105930,8	80710,7	36815,3	11650,3	19,1	28,1	806903,3
R18m60	149285,0	92118,6	60080,4	39256,2	21872,9	24055,6	14662,1	6328,9	14,6	28,1	407702,3
R18m90	110688,0	51845,8	26821,9	12228,6	5804,7	9207,0	9256,8	3650,6	9,8	22,1	229535,3
R19m0	246855,8	90544,8	47526,2	49084,6	90875,6	64302,3	25193,1	10543,3	8,3	23,2	624957,2
R19m5	194844,5	79462,4	46994,9	117145,0	125973,2	93532,6	45380,8	27891,1	78,0	32,8	731335,2
R19m10	181937,7	81256,9	66447,0	111664,3	117248,4	90997,9	42700,1	13947,6	18,6	14,0	706232,5
R19m15	165234,4	111528,9	71755,9	57463,4	54709,7	47245,8	29512,6	10131,3	15,5	13,4	547610,9
R19m30	101460,4	36921,0	15837,3	10829,4	10728,6	12862,1	11955,5	4615,8	11,5	11,4	205233,1
R19m60	31151,5	2368,9	219,1	201,6	203,8	370,4	585,1	557,3	7,7	11,2	35676,6
R19m90	6847,8	375,6	151,6	148,7	141,8	187,3	178,1	158,8	8,7	13,5	8212,0
R20m0	229117,2	128551,6	90575,3	96444,2	81699,3	54645,0	27847,6	21415,6	42,5	31,4	730369,8
R20m5	210318,0	122298,8	88214,6	96426,6	81196,1	47686,2	23851,7	11665,4	33,0	25,0	681715,3
R20m10	141428,7	46463,8	22989,6	23076,1	60160,9	39922,1	17029,7	6635,6	7,1	8,2	357721,7
R20m15	152757,3	79697,0	19850,4	19121,9	41169,6	32652,0	16801,8	7062,6	6,3	9,8	369128,8
R20m30	87573,4	16478,6	5000,0	3503,8	2246,6	2713,9	7874,3	3836,8	13,5	5,4	129246,3
R20m60	27573,9	1360,7	142,7	203,5	155,2	302,7	479,9	468,1	5,3	10,9	30702,9
R20m90	7239,2	231,2	78,5	178,7	140,0	119,4	88,9	70,9	4,8	7,5	8159,0

## APPENDIX 2. – EXPERIMENTAL FACTORS AND LOGS

Run	Date	Order of experiment	Deionized water (mL)	Na2O4S.10H2O (g)	Na2SO4 (g)	PFAS stock (ul)	Flow rate (mL/min)	Current (A)	pH (time (min) and pH							T °C (time (min) and T°C)							
1	23.05.2022	15	1000	0	7,103	303,6	1500	32,12	0	0,5	5	10	15	30	60	90 Minutes	0	5	10	15	30	60	90
2	16.05.2022	5	1000	16,11	0	658,4	1000	22,084	0		5	10	15	30	60	90 Minutes	0	5	10	15	30	60	90
3	16.05.2022	6	1000	16,109	0	658,4	1000	22,084	0	2	5	10	15	30	60	90 Minutes	0	5	10	15	30	60	90
4	12.05.2022	4	1000	16,112	0	304	500	12,045	0		5	10	15	30	60	90 Minutes	0	5	10	15	30	60	90
5	24.05.2022	20	1000	0	7,101	658	159,1	22,084	0	1	5	10	15	30	60	90 Minutes	0	5	10	15	30	60	90
6	19.05.2022	7	1000	16,112	0	658,4	1000	22,084	0		5	10	15	30	60	90 Minutes	0	5	10	15	30	60	90
7	19.05.2022	8	1000	16,11	0	62,2	1000	22,084	0		5	10	15	30	60	90 Minutes	0	5	10	15	30	60	90
8	11.05.2022	1	1000	16,111	0	1013	500	12,045	0		5	10	15	30	60	90 Minutes	0	5	10	15	30	60	90
9	23.05.2022	16	1000	0	7,103	1013	1500	32,12	0	0,167	5	10	15	30	60	90 Minutes	0	5	10	15	30	60	90
10	19.05.2022	9	1000	16,109	0	658,4	1000	22,084	0	0,333	5	10	15	30	60	90 Minutes	0	5	10	15	30	60	90
11	20.05.2022	11	1000	0	7,104	658	1000	38,964	0	0,5	5	10	15	30	60	90 Minutes	0	5	10	15	30	60	90
12	23.05.2022	17	1000	0	7,102	1013	1500	12,045	0	0,15	5	10	15	30	60	90 Minutes	0	5	10	15	30	60	90
13	20.05.2022	10	1000	16,11	0	658,4	1000	22,084	0		5	10	15	30	60	90 Minutes	0	5	10	15	30	60	90
14	24.05.2022	18	1000	0	7,102	304	1500	12,045	0	0,5	5	10	15	30	60	90 Minutes	0	5	10	15	30	60	90
15	21.05.2022	12	1000	0	7,104	1254	1000	22,084	0	0,233	5	10	15	30	60	90 Minutes	0	5	10	15	30	60	90
16	12.05.2022	2	1000	16,108	0	1013	500	32,12	0	0,5	5	10	15	30	60	90 Minutes	0	5	10	15	30	60	90
17	12.05.2022	3	1000	16,108	0	304	500	32,12	0	8,59	5	10	15	30	60	90 Minutes	0	5	10	15	30	60	90
18	21.05.2022	14	1000	0	7,103	658	1000	5,202	0	0,367	5	10	15	30	60	90 Minutes	0	5	10	15	30	60	90
19	21.05.2022	13	1000	0	7,103	658	1000	22,084	0	0,2	5	10	15	30	60	90 Minutes	0	5	10	15	30	60	90
20	24.05.2022	19	1000	0	7,103	658	1841	22,084	0	0,2	5	10	15	30	60	90 Minutes	0	5	10	15	30	60	90
									5,79	9,94	8,28	7,34	8	9,2	10,02	10,95	20,3	27,3	27,7	27	29,5	34,9	36,1



Run	Foaming	Little foaming	No foaming	( Comments
1	-	yes	<10	
2	Yes		18	30 pH quickly rose to 9 (possibly at 10-30s) 40 second disconnect from power, recorded in power logs, was added to sampling times (for 60 and 90 min) Channel 2 was disconnected at the same time but was out until 57 min, also in power logs
3	yes		10 <26	
4	-	Yes	-	Ran for 30 s without logging, restarted with logging Didnt note when the foaming ended
5	Yes		15	24 Foaming was just around the outlet from the reactor by 2 cm and then when less foaming 1 cm
6	Yes	-	<30	
7	No			
8	Yes	>8	-	pH meter stopped being in the solution at some point Dont know when foaming stopped
9	Yes(heavy)		30 <40	pH rapidly changing up and down at 5 min, stabilized at 8 min
10	Yes		30 <36	pH at 5min could have been 8,99 and T 22,0
11	Yes (heavy)	-	<20	Max T 43,5 C Forgot to record pH and T at 10 min
12	Yes		30 <44	Spiking in pH from 30 s to 15 (more stable, but not entirely) fully stable atleast before 58 min
13	Yes	-	<28	
14	-	Yes		21
15	Yes (heavy)	-	<50	
16	yes	-	~20	
17	-	-	-	Didnt note if there was any foaming
18	-	Yes	<42	pH jumping around at 5 min, also at 10 min
19	Yes	-		25
20	Yes		10 <30	Unstability of pH between 0-10 min

## APPENDIX 3. – STATISTICAL ANALYSIS OF UV-VIS AND RESIDUAL CONCENTRATIONS

### Descriptive statistics

Data needs to be normalised before PCA

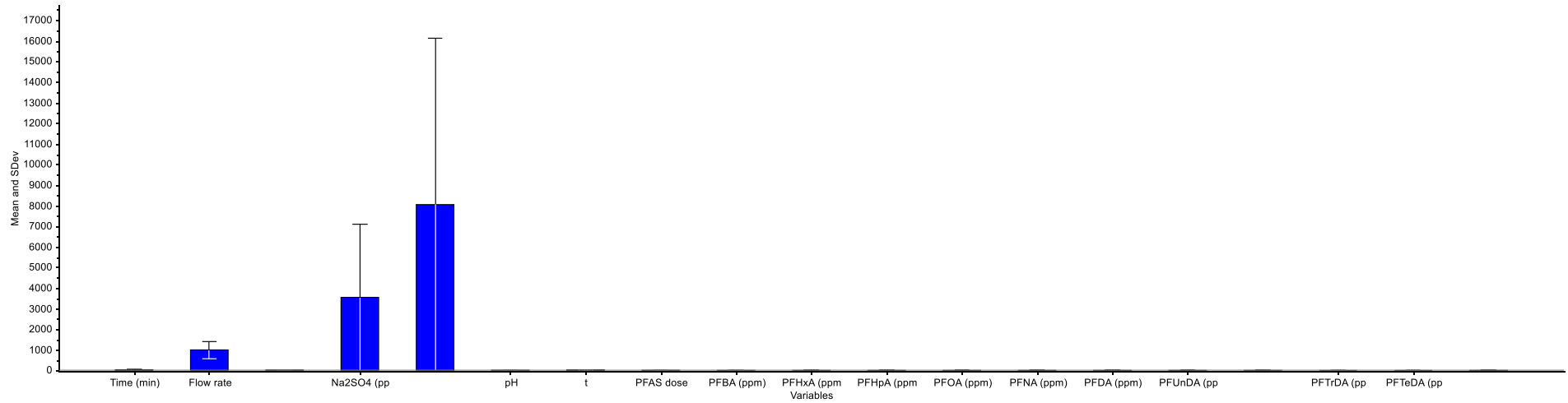

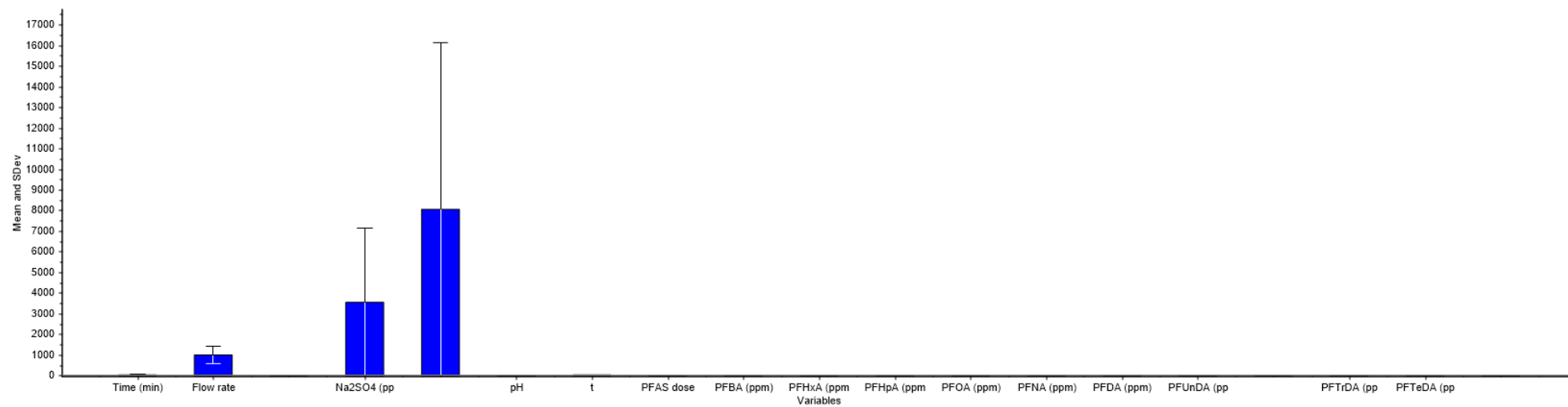
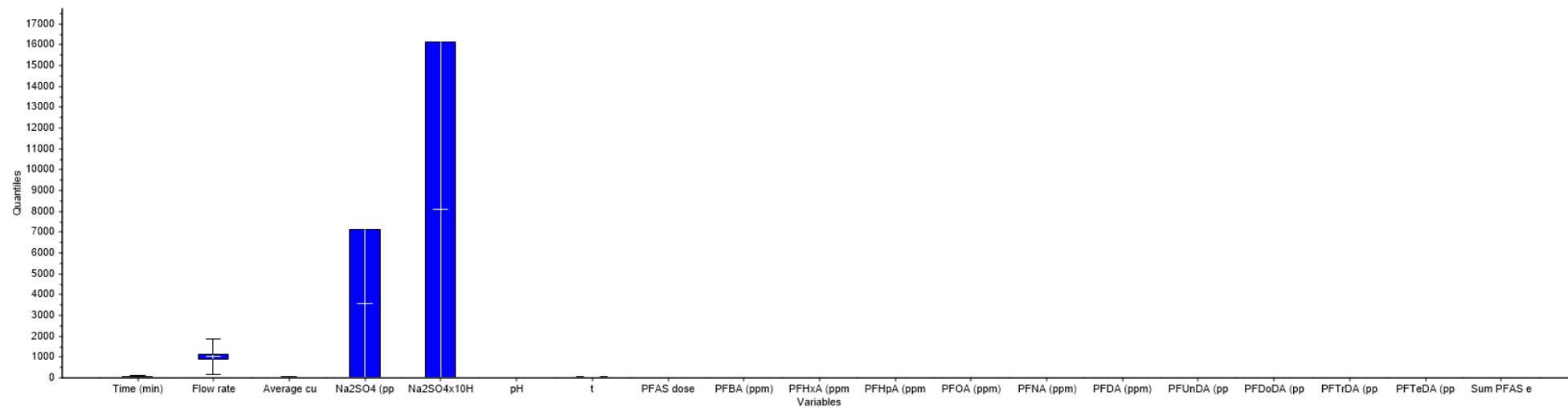

## Correlation coefficients

	Time	Flow rate	Average current	Na2SO4 (g)	Na2SO4x10H2O	pH	t	PFAS dose	PFBA	PFHxA	PFHpA	PFOA	PFNA	PFDA	PFUnDA	PFDoDA	PFTTrDA	PFTeDA	Sum PFAS
Time (min)	1	1,11E-06	0,280439734	0,000464	-0,000463657	0,631	0,54	-4,59E-07	-0,4	-0,402	-0,403	-0,41	-0,4	-0,38	-0,3599	-0,4153	-0,331	-0,036	-0,39945
Flow rate (mL/min)	####	1	-1,75E-05	0,484007	-0,483965129	4E-04	0,04	-8,23E-05	-0,1	-0,13	-0,087	-0,07	-0,06	-0,09	-0,1028	-0,0871	-0,067	0,0151	-0,08576
Average current (A)	0,28	-1,75E-05	1	0,002536	-0,002529265	0,606	0,86	-5,72E-05	0	-0,082	-0,123	-0,1	-0,05	0,005	0,04267	0,01467	0,0204	0,09485	-0,04971
Na2SO4 (ppm)	0	0,484007	0,002535856	1	-1	-0,2	0,02	0,203071	0,06	-0,064	-0,003	0,021	0,001	-0,05	-0,0831	-0,0979	-0,17	-0,1849	-0,01039
Na2SO4x10H2O (ppm)	-0	-0,48397	-0,002529265	-1	1	0,196	-0	-0,203045	-0,1	0,064	0,0033	-0,02	-0	0,054	0,08308	0,09795	0,17	0,18495	0,010405
pH	0,63	0,000437	0,606304348	-0,19641	0,196404949	1	0,63	-0,454176	-0,6	-0,547	-0,568	-0,56	-0,53	-0,48	-0,4369	-0,4653	-0,327	0,09506	-0,5443
t	0,54	0,043955	0,864830613	0,016207	-0,016218662	0,632	1	0,0279005	-0,2	-0,215	-0,264	-0,24	-0,19	-0,14	-0,1116	-0,1544	-0,12	0,04094	-0,19725
PFAS dose (ppm)	####	-8,23E-05	-5,72E-05	0,203071	-0,203045458	-0,45	0,03	1	0,51	0,417	0,4478	0,449	0,442	0,415	0,40302	0,38921	0,2113	-0,2308	0,460418
PFBA (ppm)	-0,4	-0,0577	-0,02443968	0,05794	-0,057930049	-0,56	-0,2	0,5128233	1	0,949	0,9195	0,892	0,89	0,881	0,87442	0,85922	0,6467	-0,0088	0,945292
PFHxA (ppm)	-0,4	-0,13027	-0,081867933	-0,06421	0,064215928	-0,55	-0,2	0,4167404	0,95	1	0,9707	0,944	0,94	0,932	0,91941	0,88007	0,6842	0,06364	0,98042
PFHpA (ppm)	-0,4	-0,08725	-0,123245217	-0,00327	0,003277472	-0,57	-0,3	0,4478193	0,92	0,971	1	0,991	0,973	0,939	0,9139	0,88923	0,7294	0,04936	0,985091
PFOA (ppm)	-0,4	-0,07019	-0,103913672	0,021439	-0,021428436	-0,56	-0,2	0,4493426	0,89	0,944	0,9906	1	0,986	0,945	0,91122	0,88572	0,7313	0,03775	0,979067
PFNA (ppm)	-0,4	-0,06404	-0,050275475	0,001212	-0,001198659	-0,53	-0,2	0,4424711	0,89	0,94	0,9728	0,986	1	0,981	0,95277	0,91741	0,7608	0,05096	0,985779
PFDA (ppm)	-0,4	-0,08812	0,005032149	-0,05349	0,053507403	-0,48	-0,1	0,4153884	0,88	0,932	0,9393	0,945	0,981	1	0,99015	0,94551	0,7972	0,09134	0,976326
PFUnDA (ppm)	-0,4	-0,10278	0,042665195	-0,08306	0,083079875	-0,44	-0,1	0,4030201	0,87	0,919	0,9139	0,911	0,953	0,99	1	0,95475	0,8108	0,11469	0,960397
PFDoDA (ppm)	-0,4	-0,08706	0,01466981	-0,09794	0,09795104	-0,47	-0,2	0,3892082	0,86	0,88	0,8892	0,886	0,917	0,946	0,95475	1	0,878	0,16617	0,930636
PFTTrDA (ppm)	-0,3	-0,06736	0,020448603	-0,17004	0,17003724	-0,33	-0,1	0,2113277	0,65	0,684	0,7294	0,731	0,761	0,797	0,81076	0,87799	1	0,51779	0,759443
PFTeDA (ppm)	-0	0,015101	0,09485101	-0,18494	0,184949443	0,095	0,04	-0,230819	-0	0,064	0,0494	0,038	0,051	0,091	0,11469	0,16617	0,5178	1	0,054642
Sum PFAS excl PFPA&6	-0,4	-0,08576	-0,049707566	-0,01039	0,010404713	-0,54	-0,2	0,4604181	0,95	0,98	0,9851	0,979	0,986	0,976	0,9604	0,93064	0,7594	0,05464	1

# Scores grouped by Na2SO4

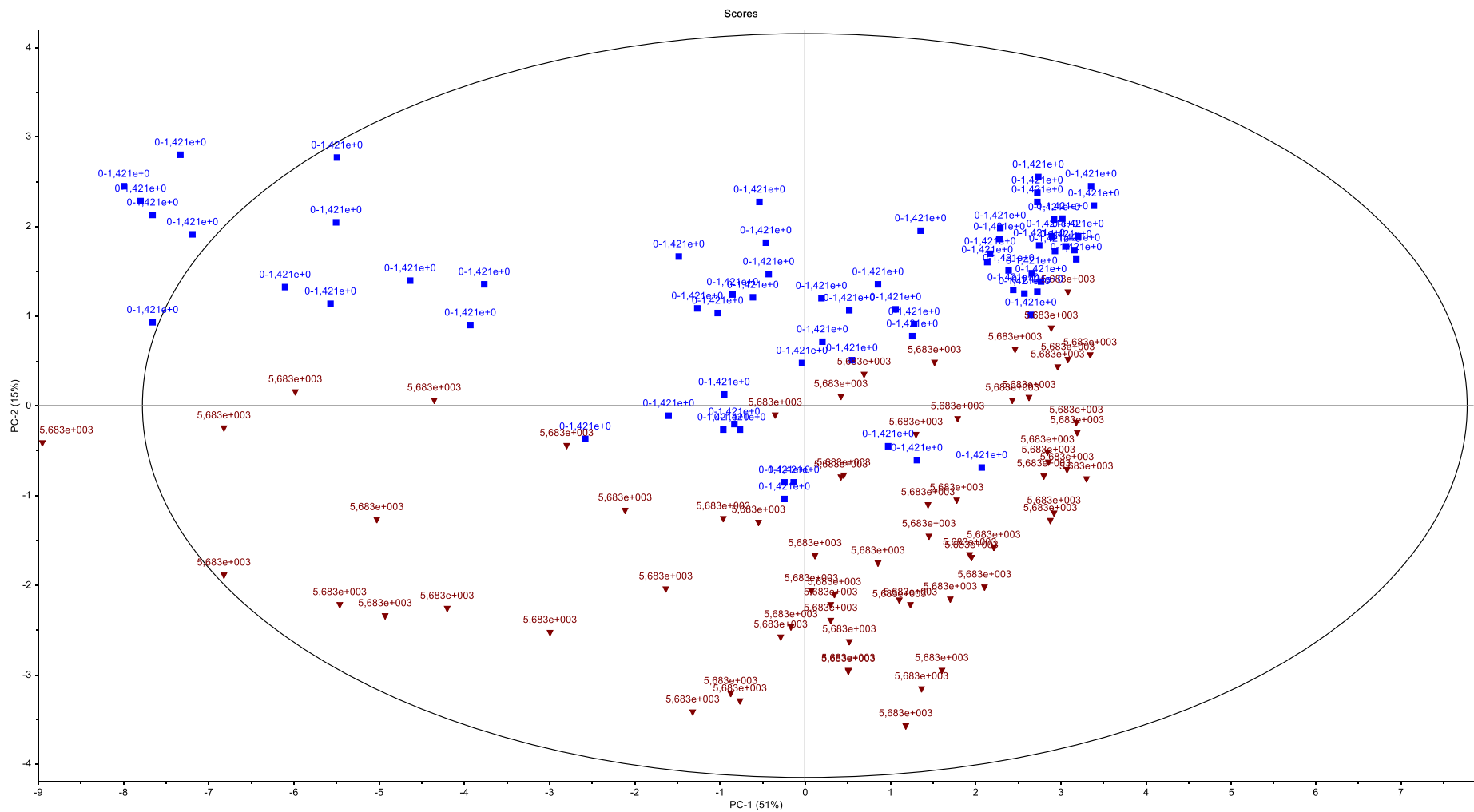

# Scores grouped by Na<sub>2</sub>SO<sub>4</sub>·10H<sub>2</sub>O

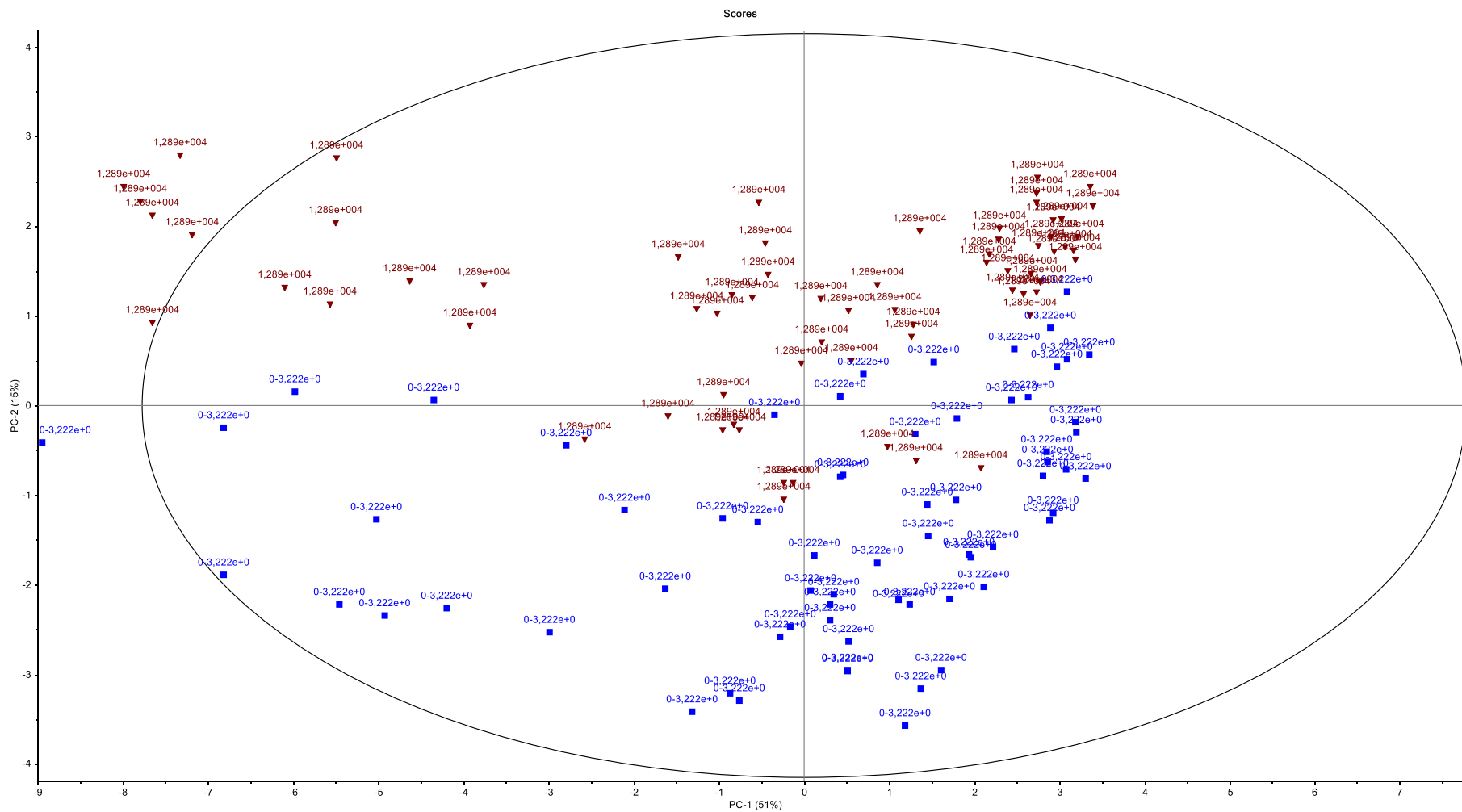

Scores grouped by SumPFAS (analysed)

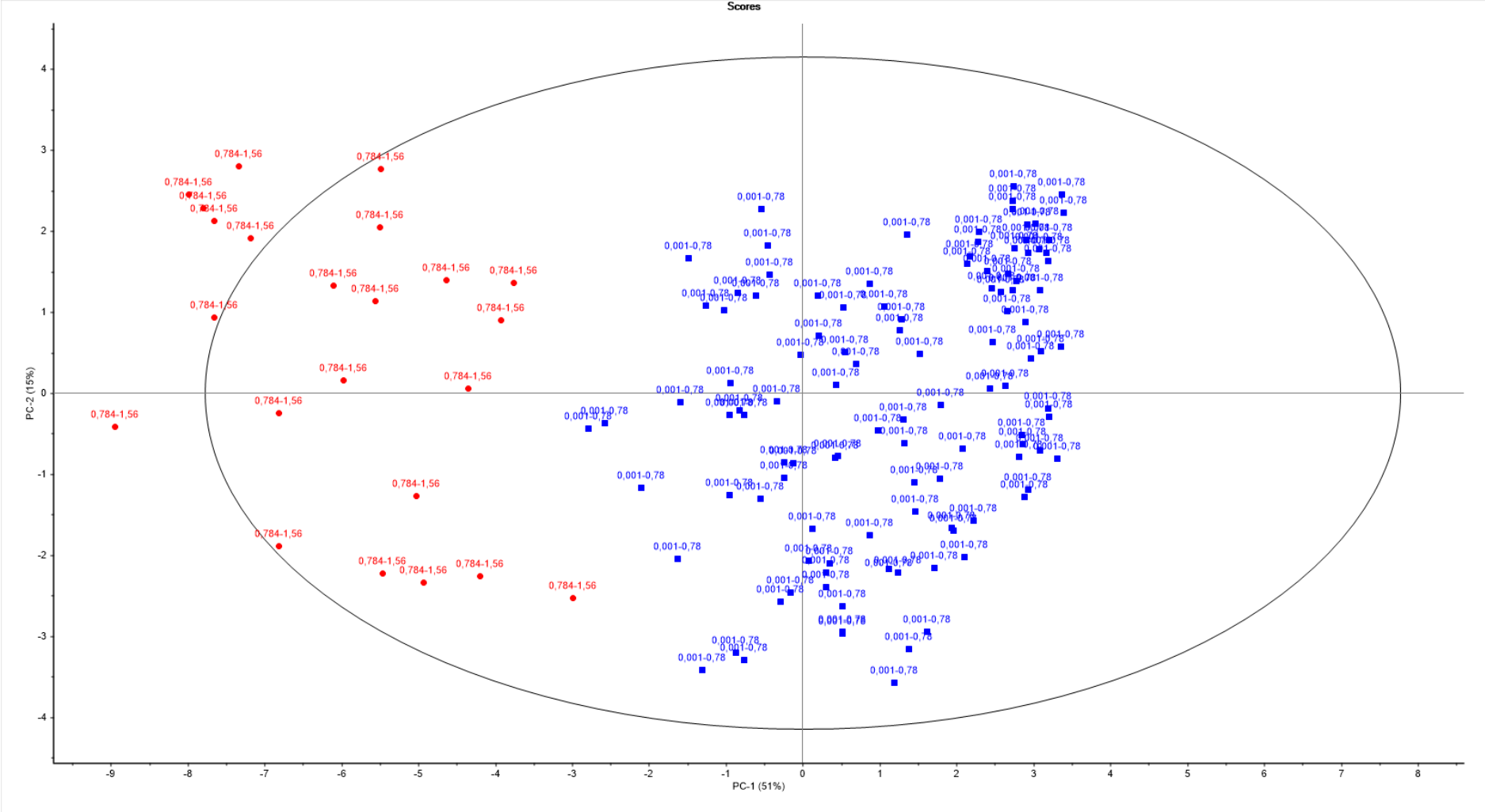

Samples grouped by average current:

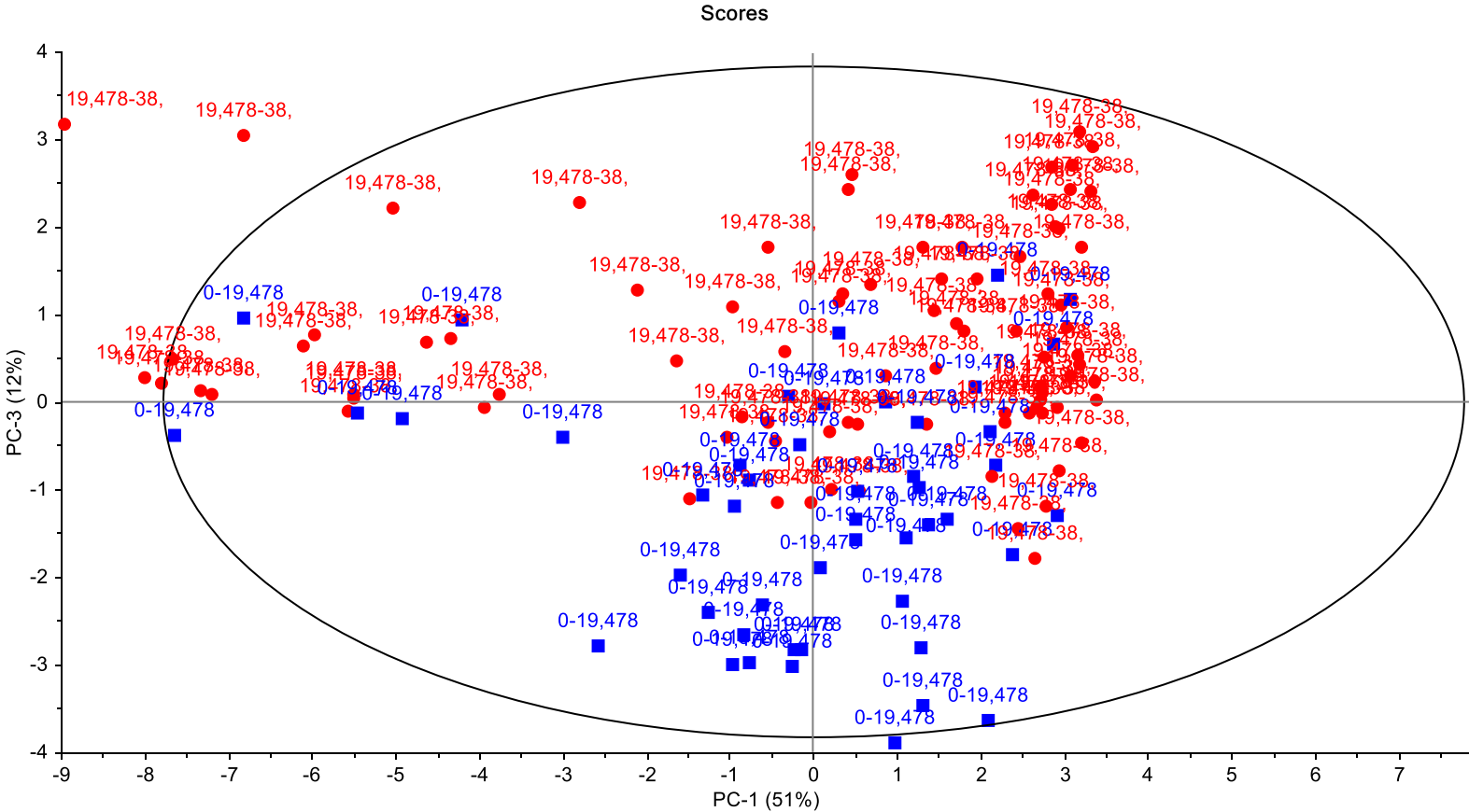



# Loadings

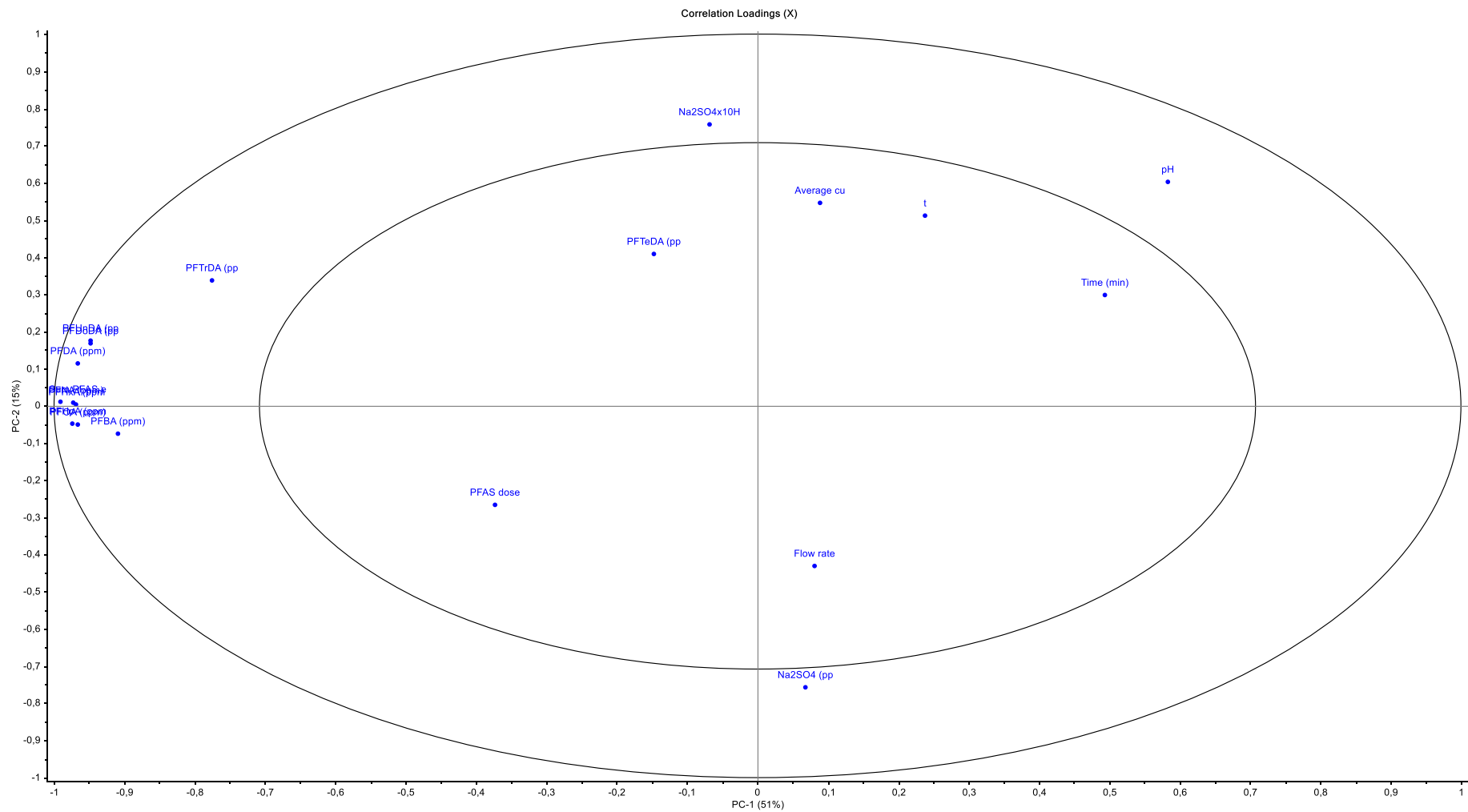

## Conclusions for PCA

1. Variables negatively correlated to PC-1 and positively correlate to each other:

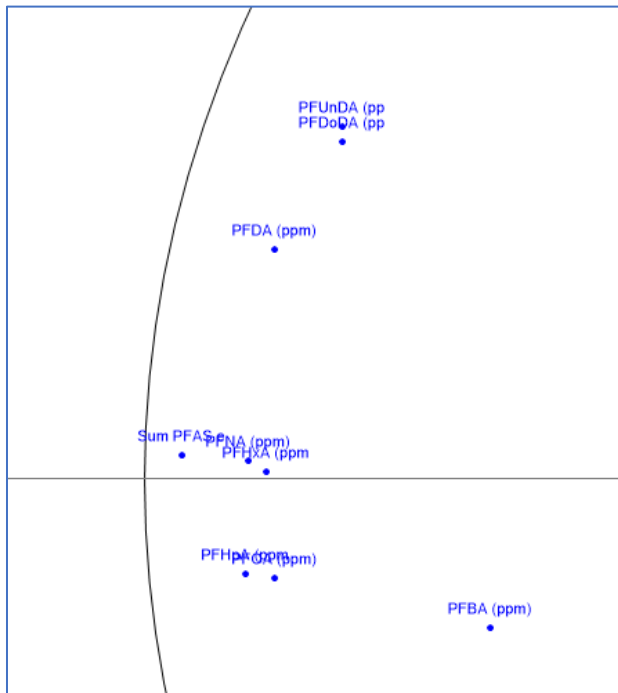

2. Variables positively correlated with PC2 and positively correlated to each other:

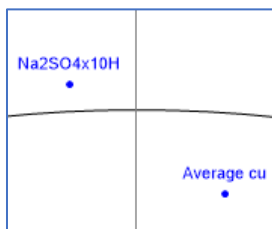

3. Negatively correlated to PC-2:

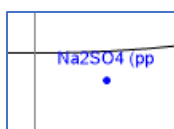

Variables taken further to the model: SumPFASanalysed (target), Na2SO4x10H2O, Na2SO4, Average current, Flow rate, time, pH.

PLSR

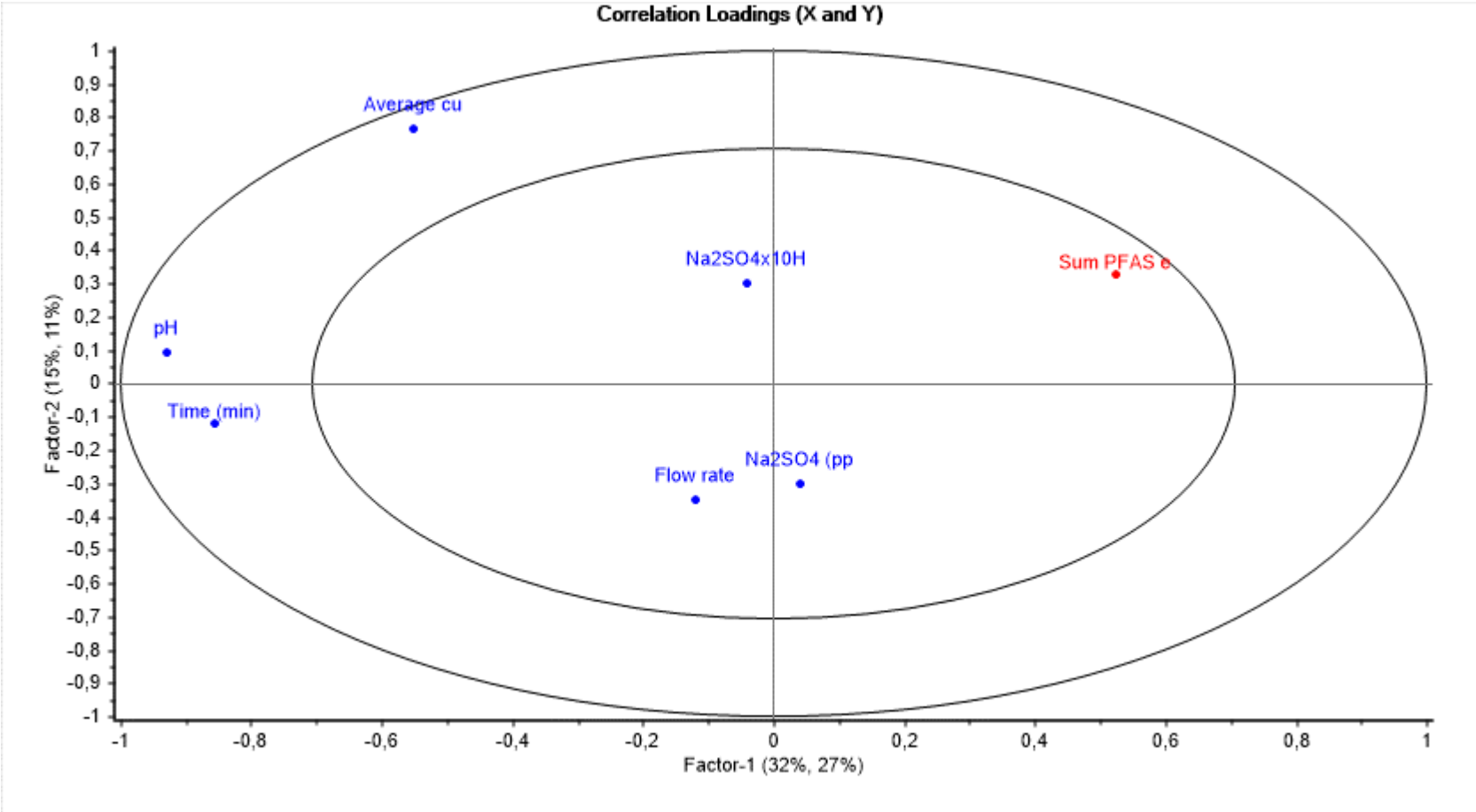

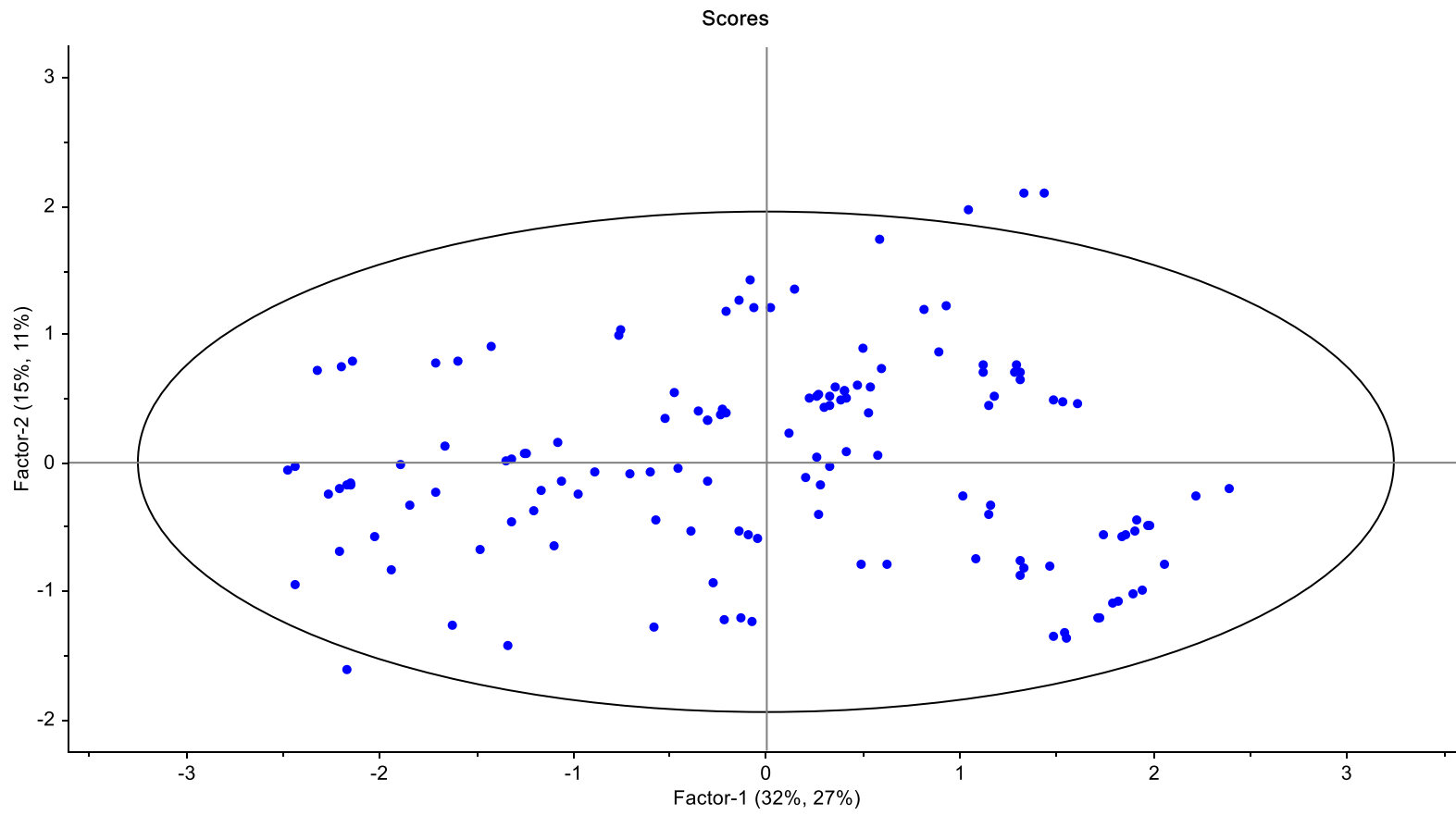

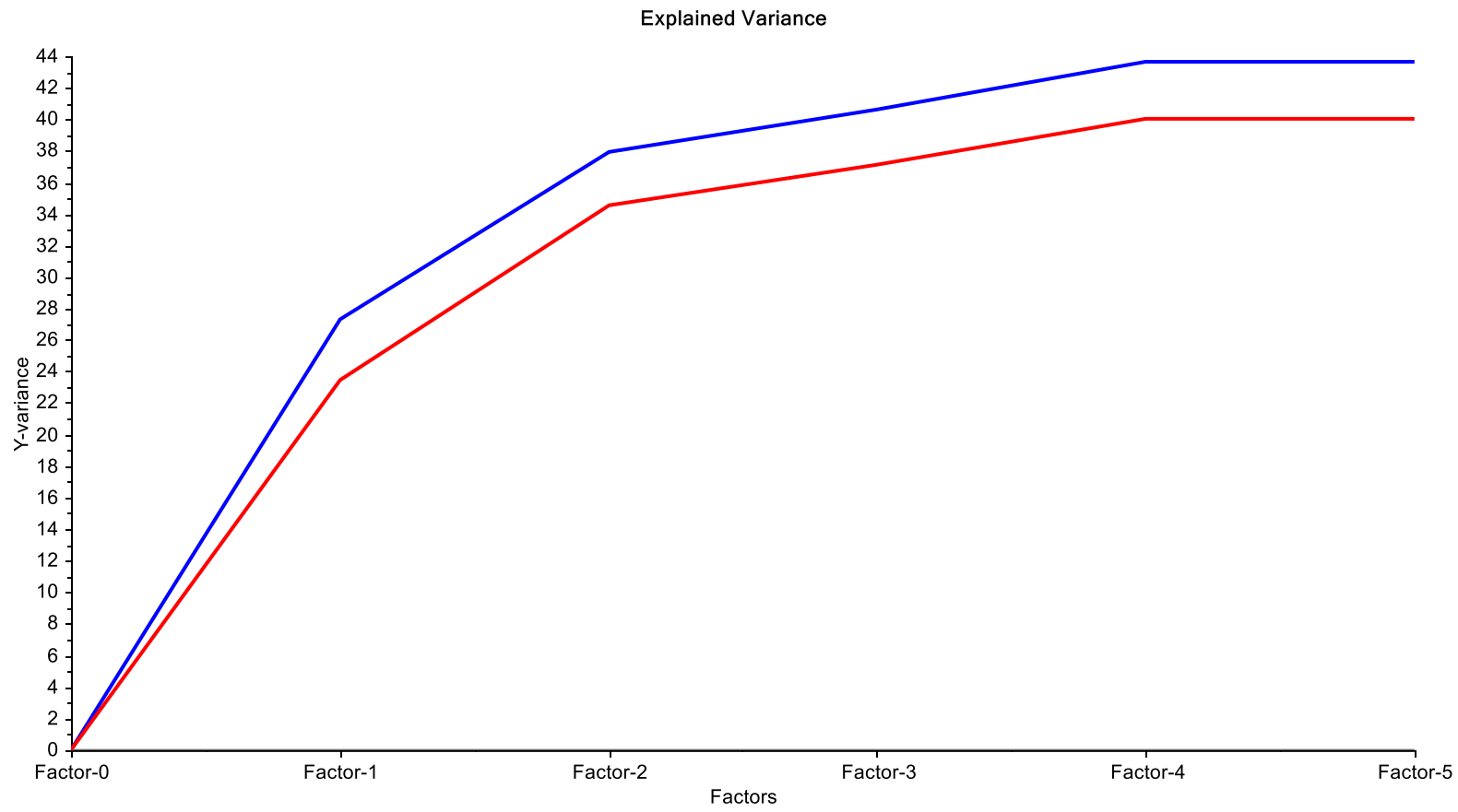

Predicted vs. Reference

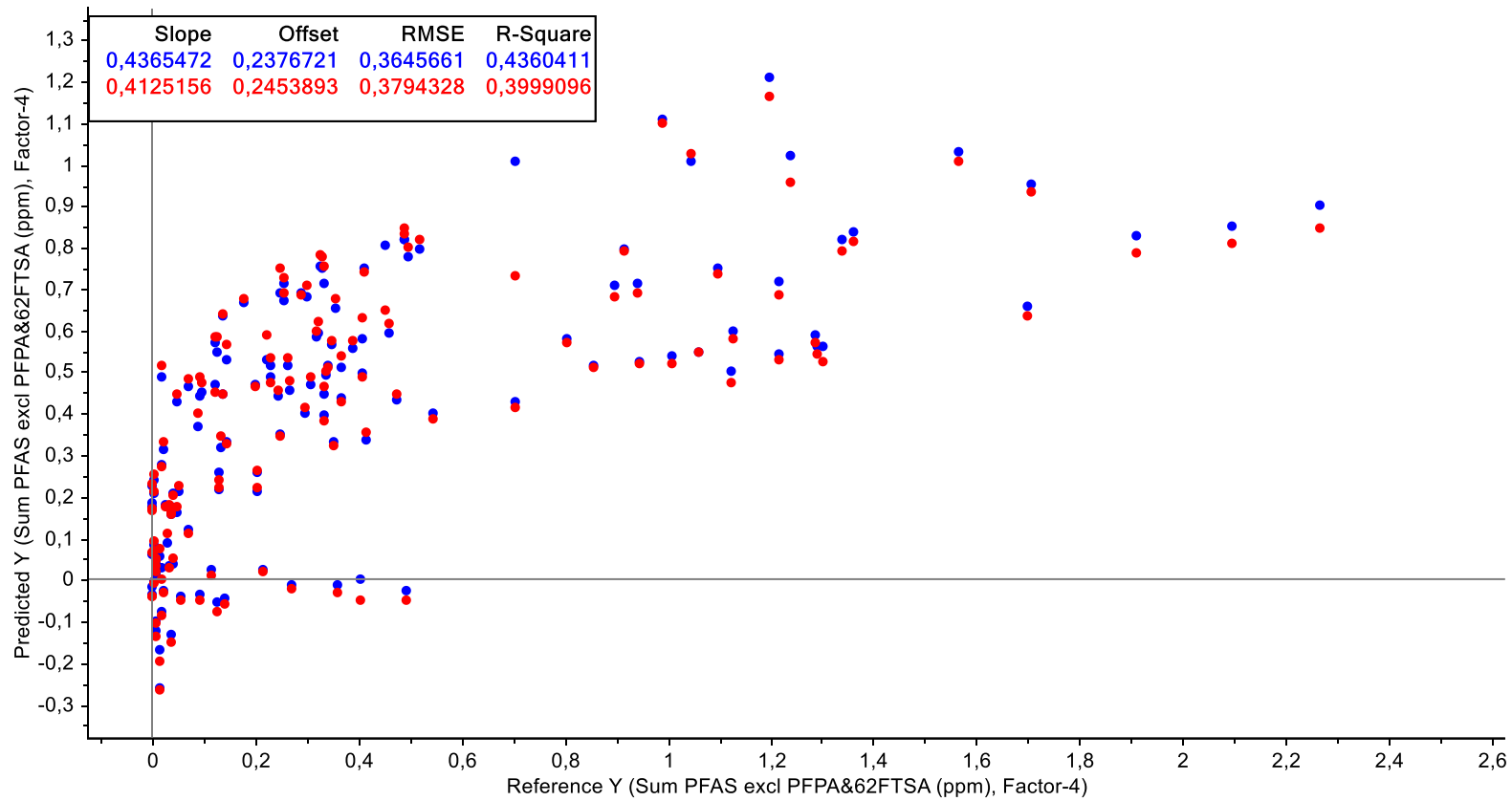

# Untreated spectra



After region cut

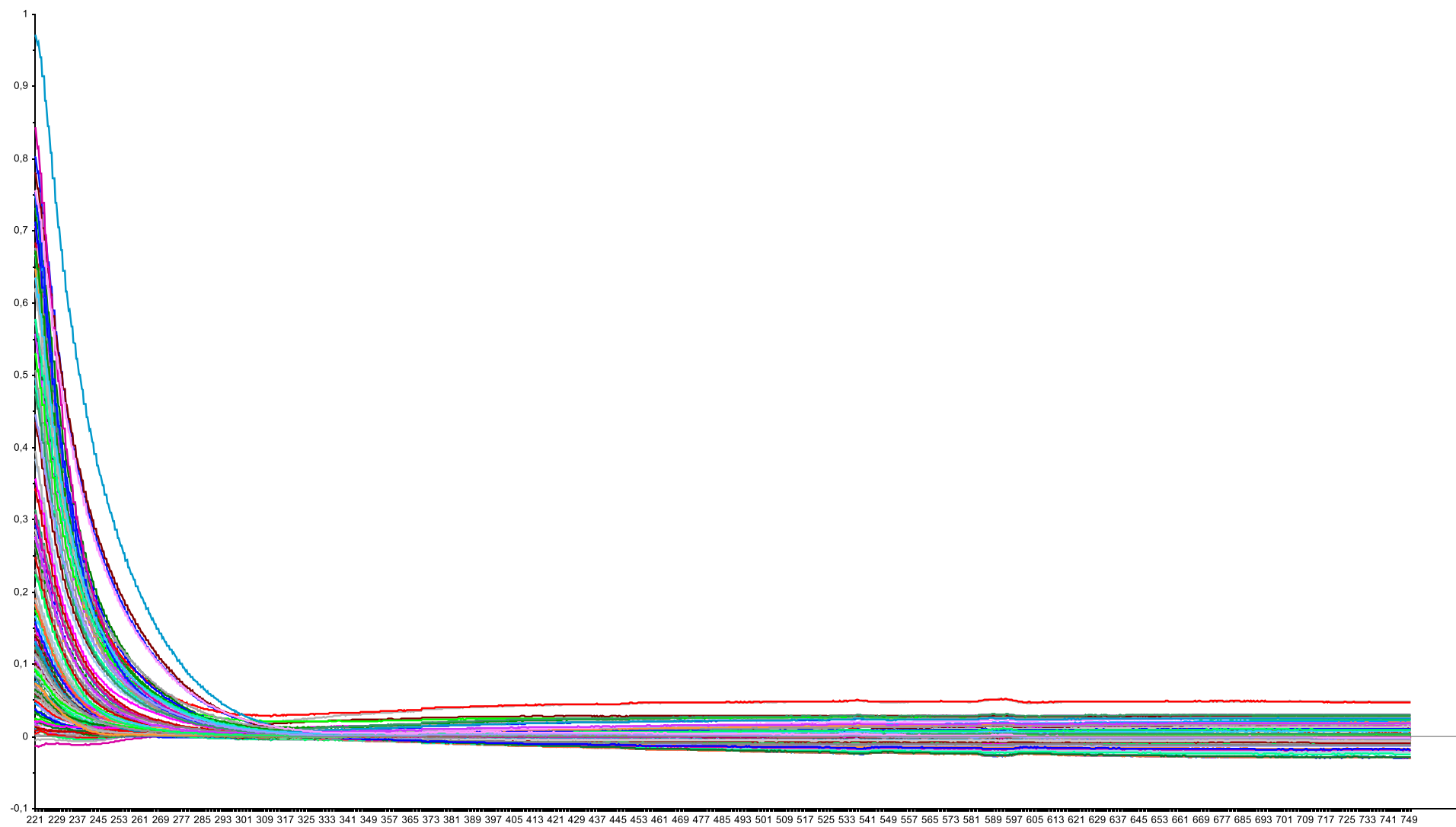



# Scatter effects

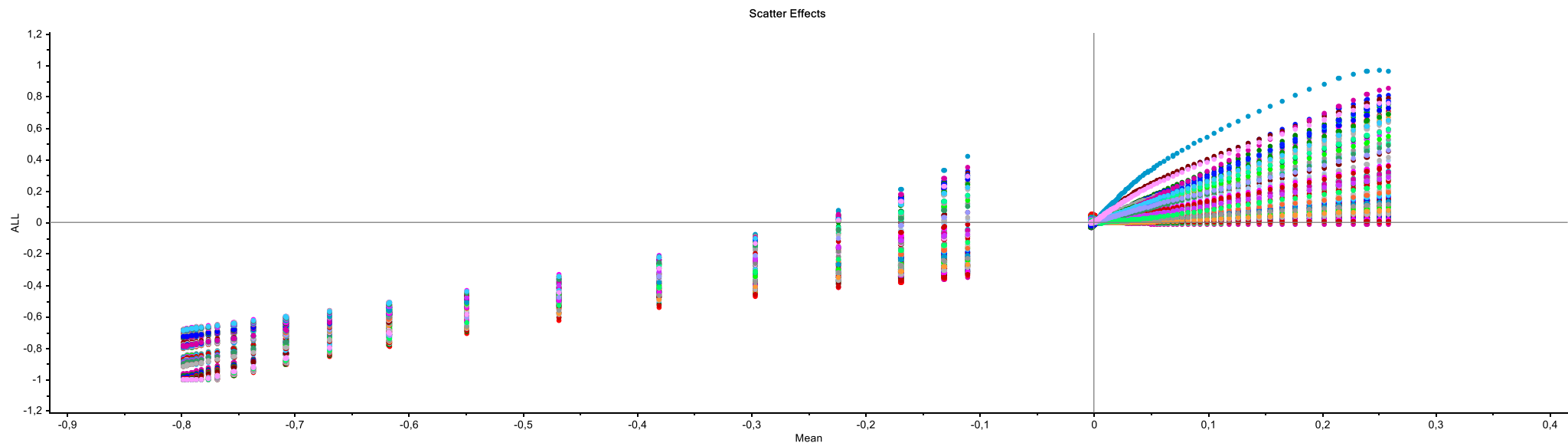

# Corrected baseline normalised spectra

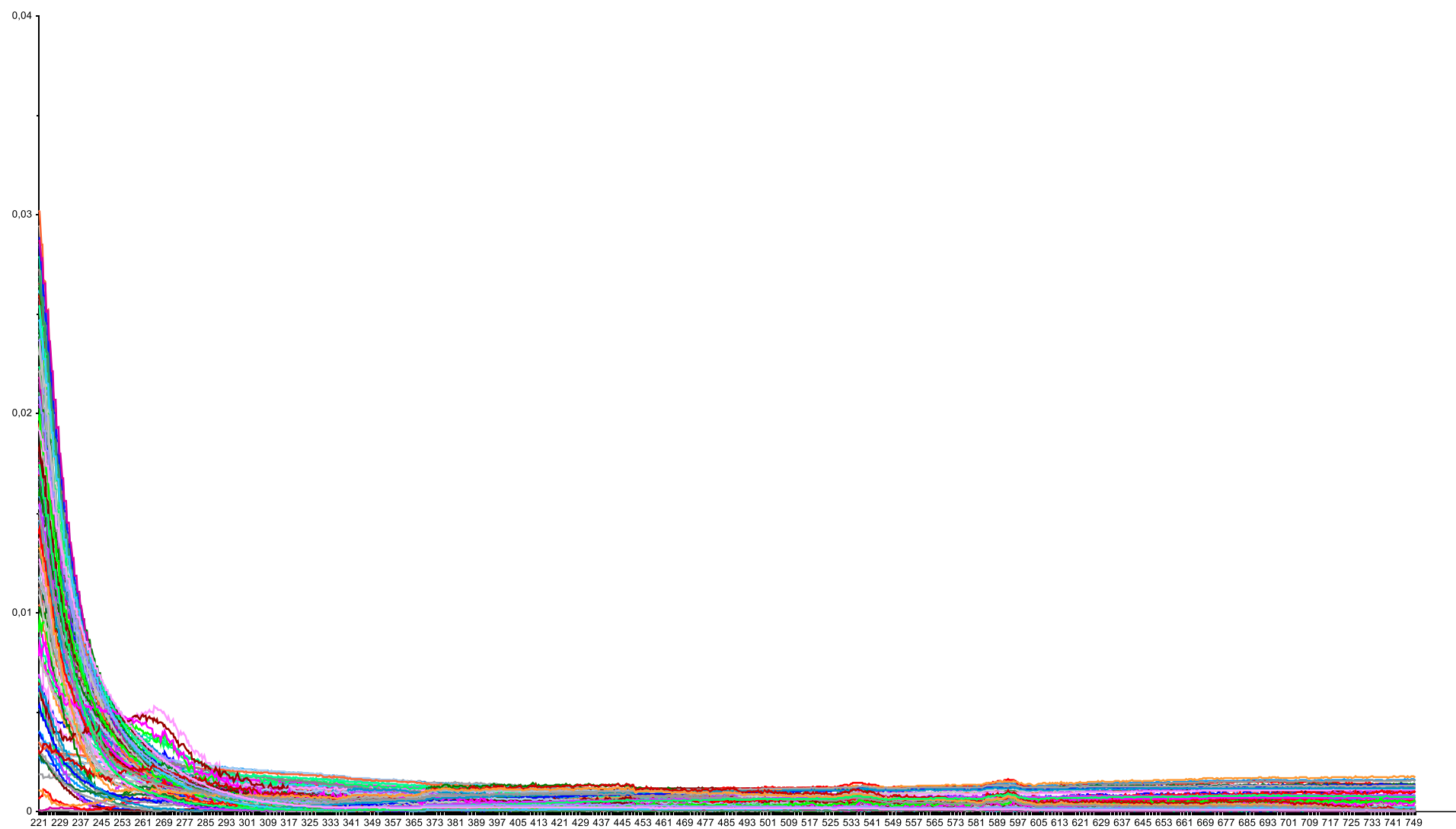

After correction

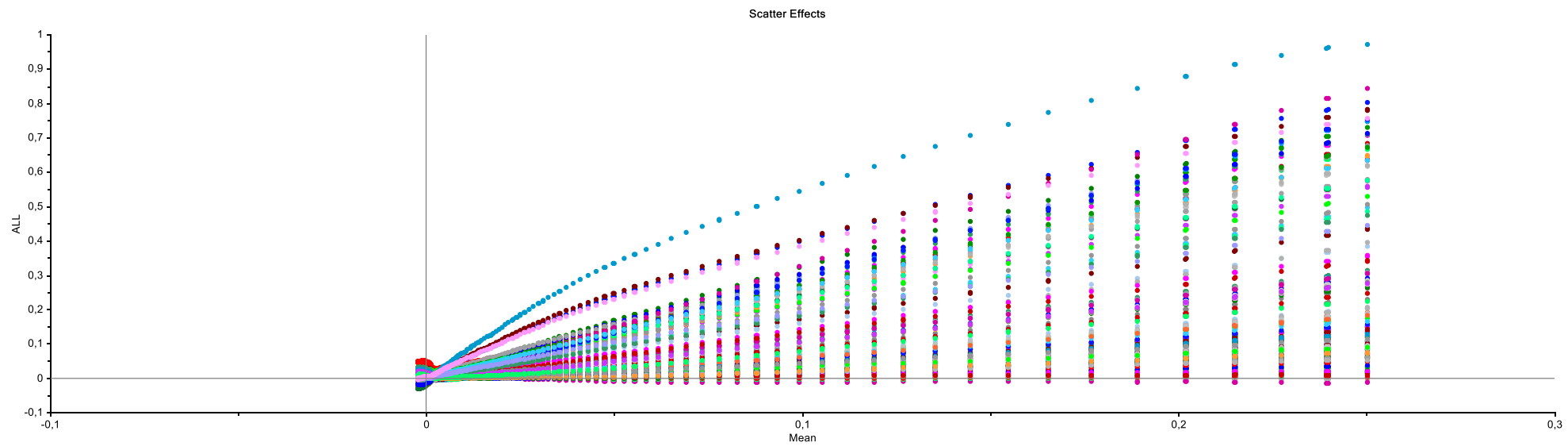

# Feature extraction with PCA

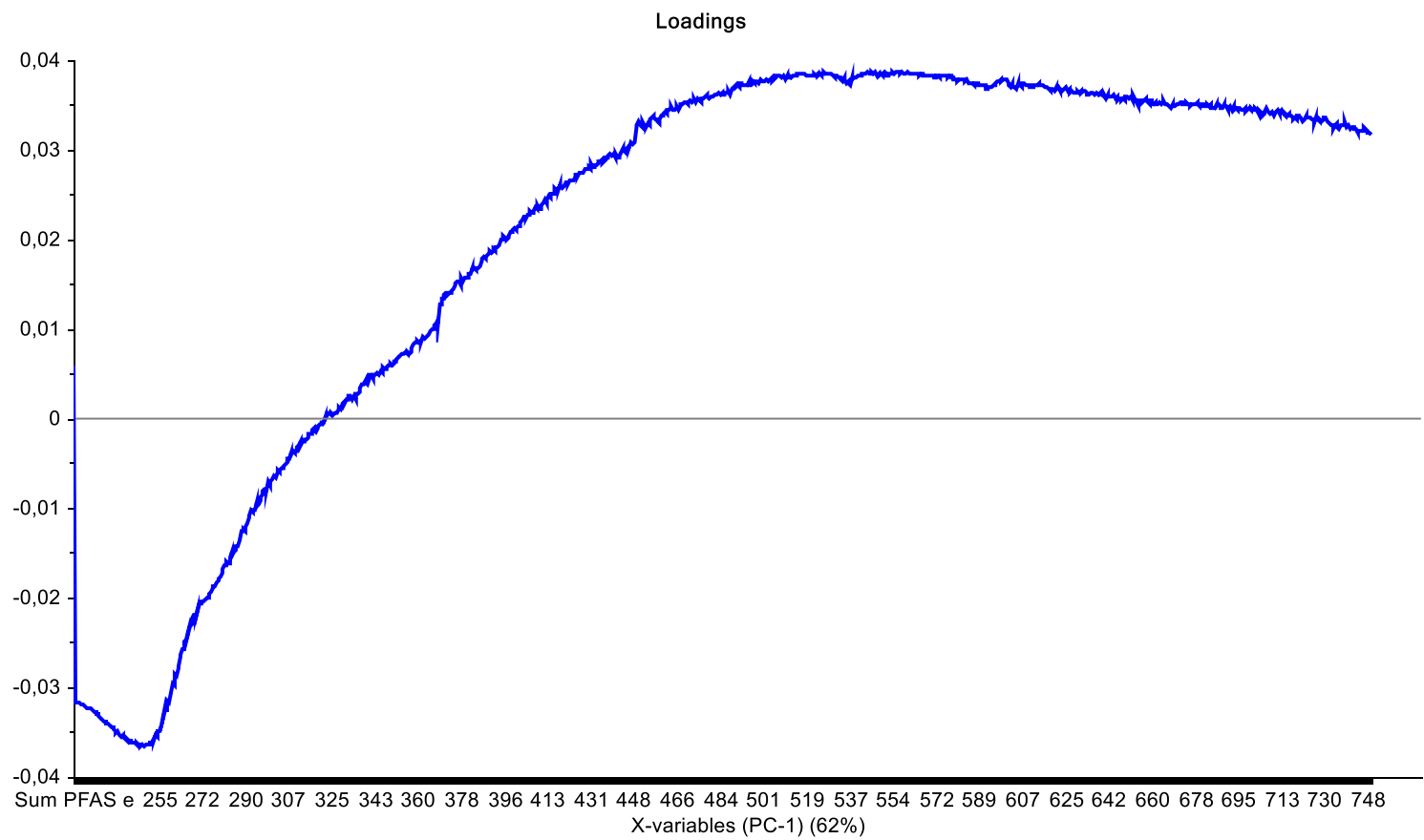

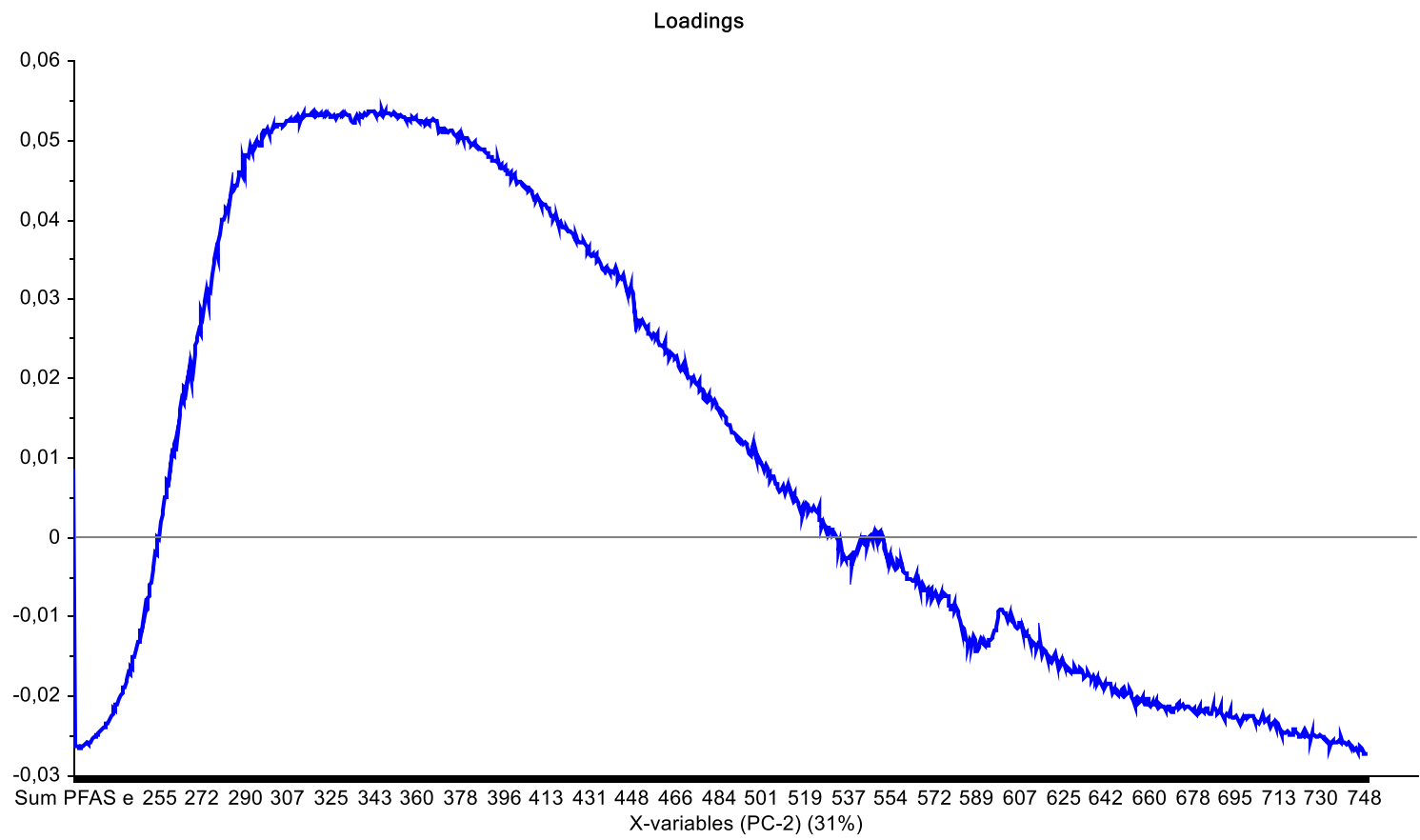

### Loadings

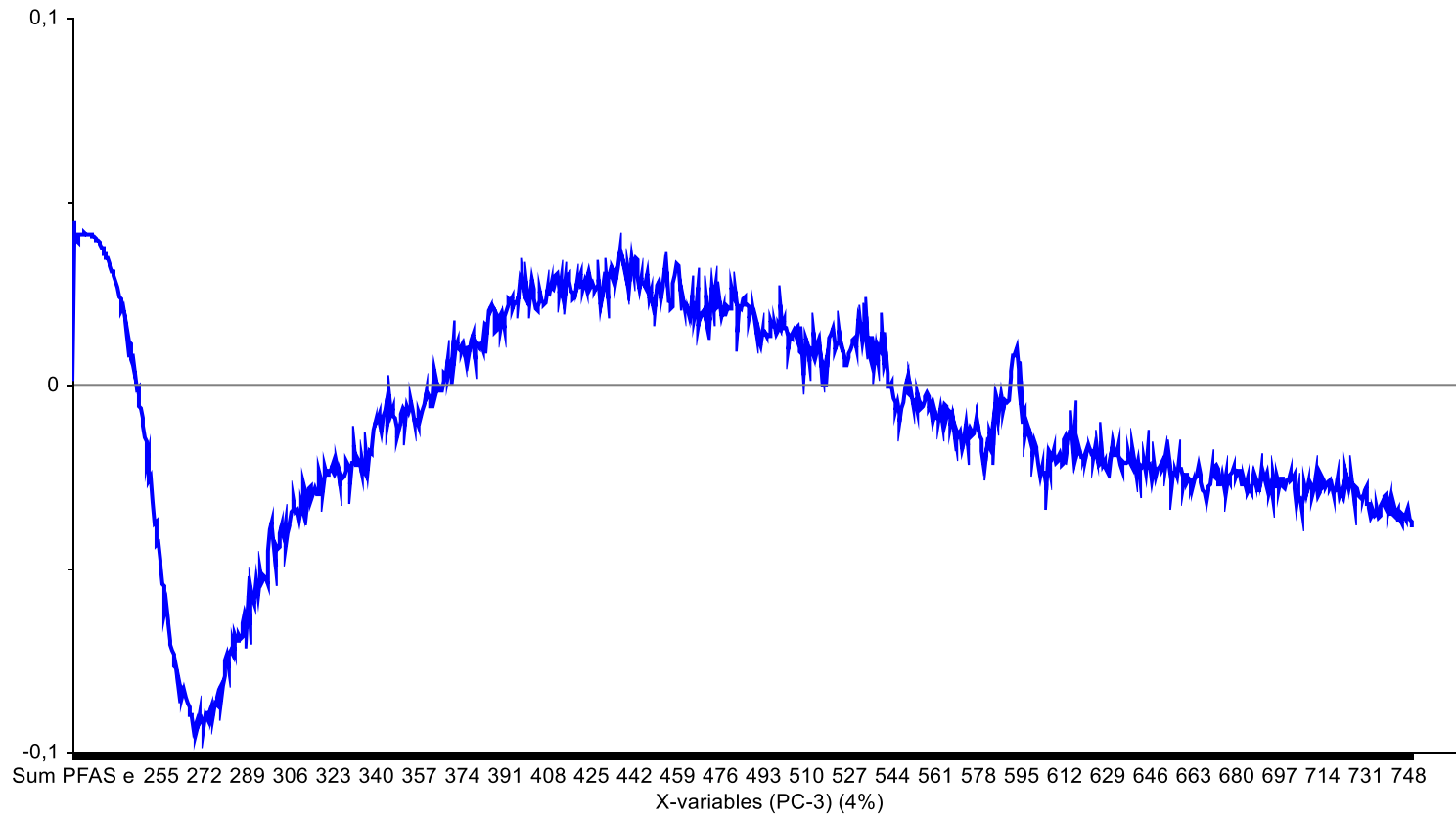

### Loadings

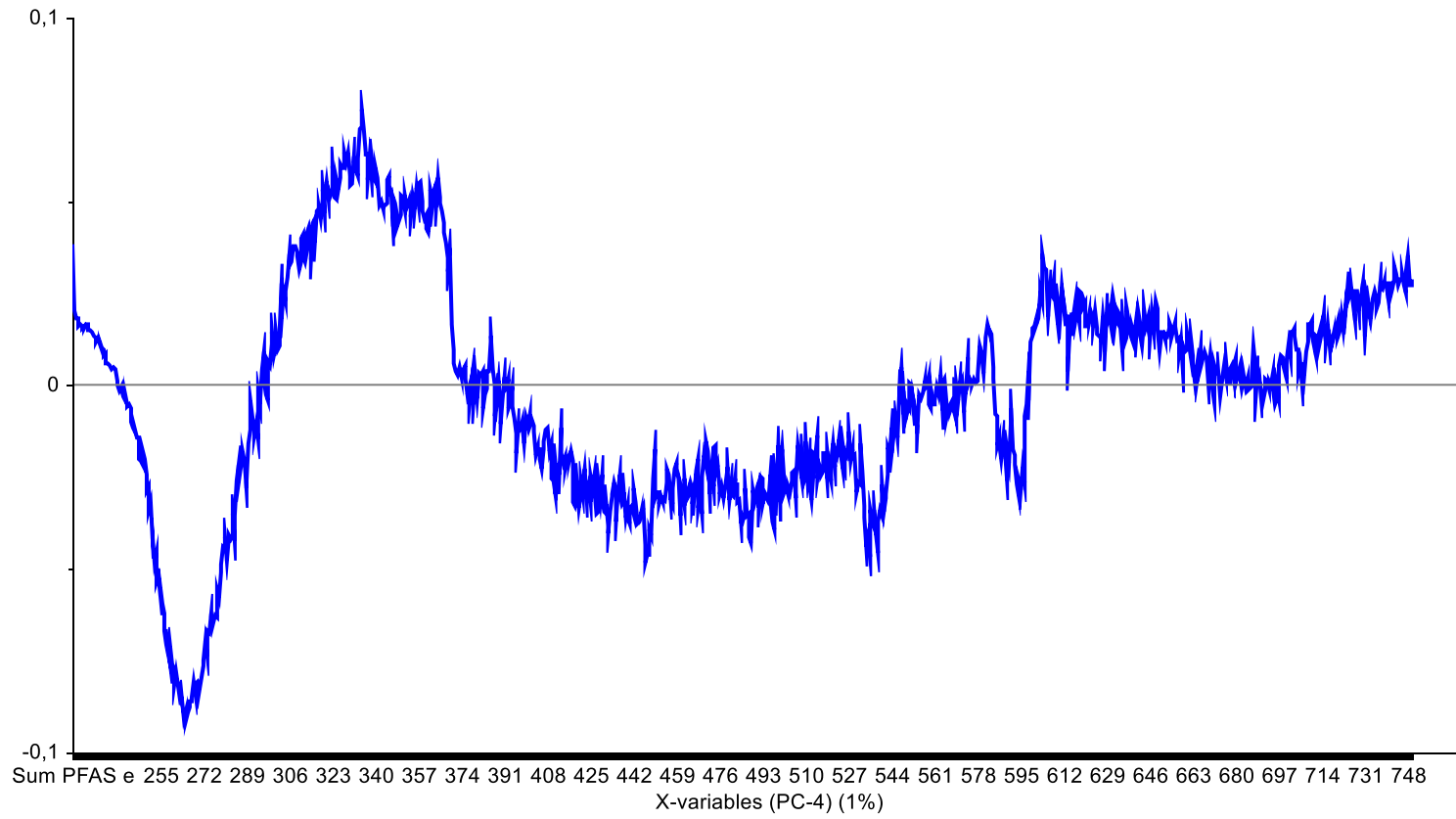

# PLS including features

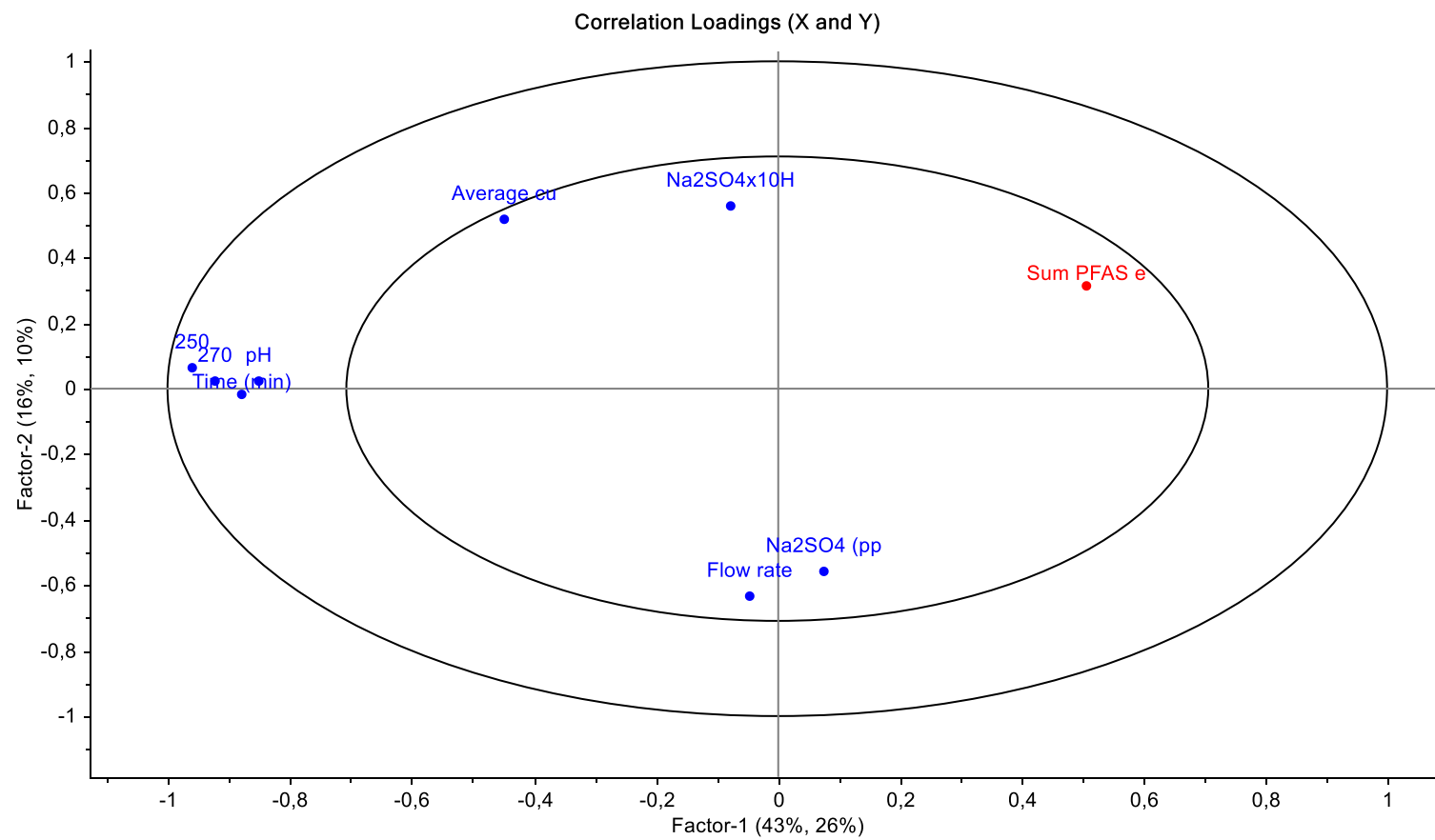



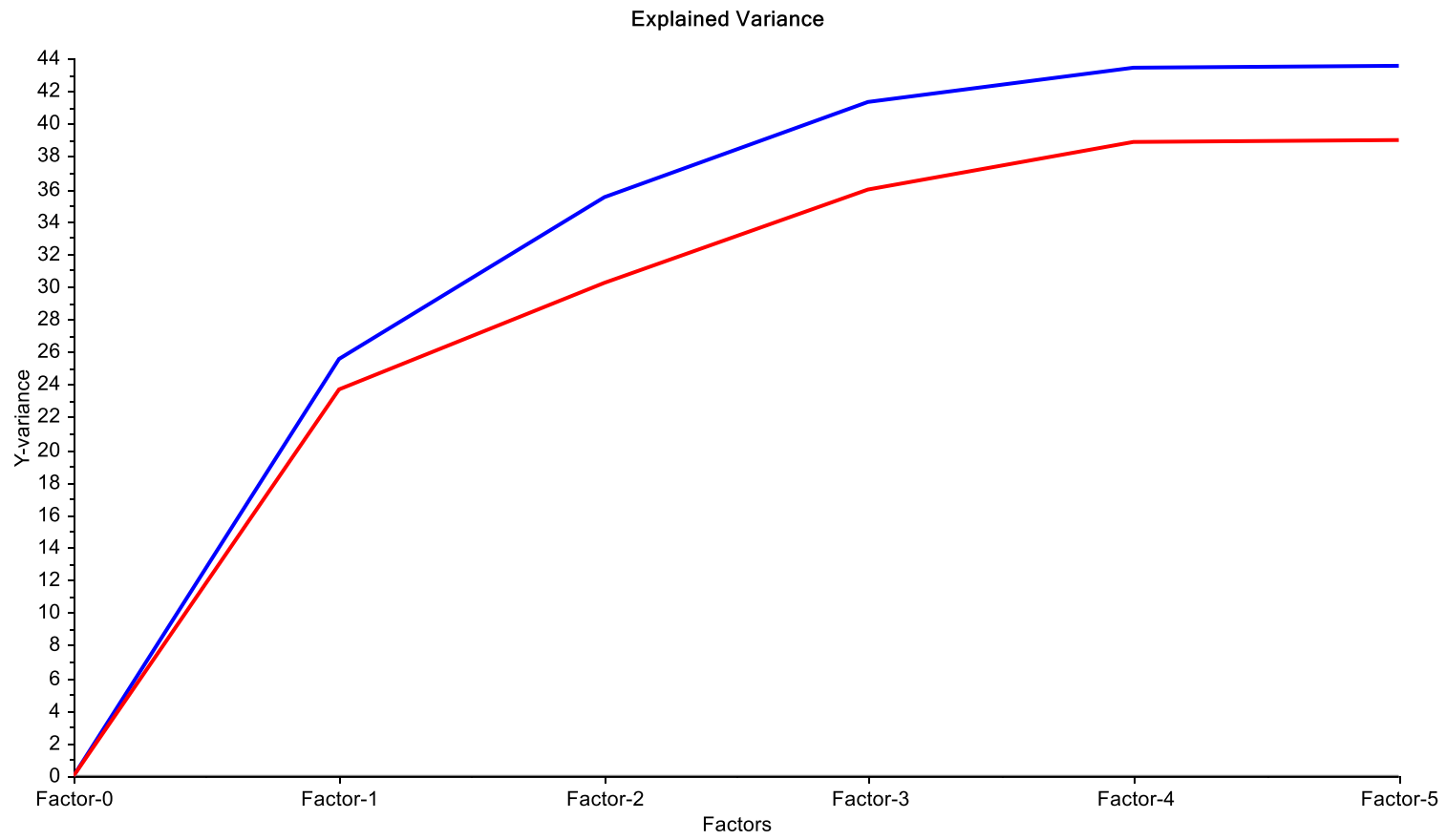

Predicted vs. Reference

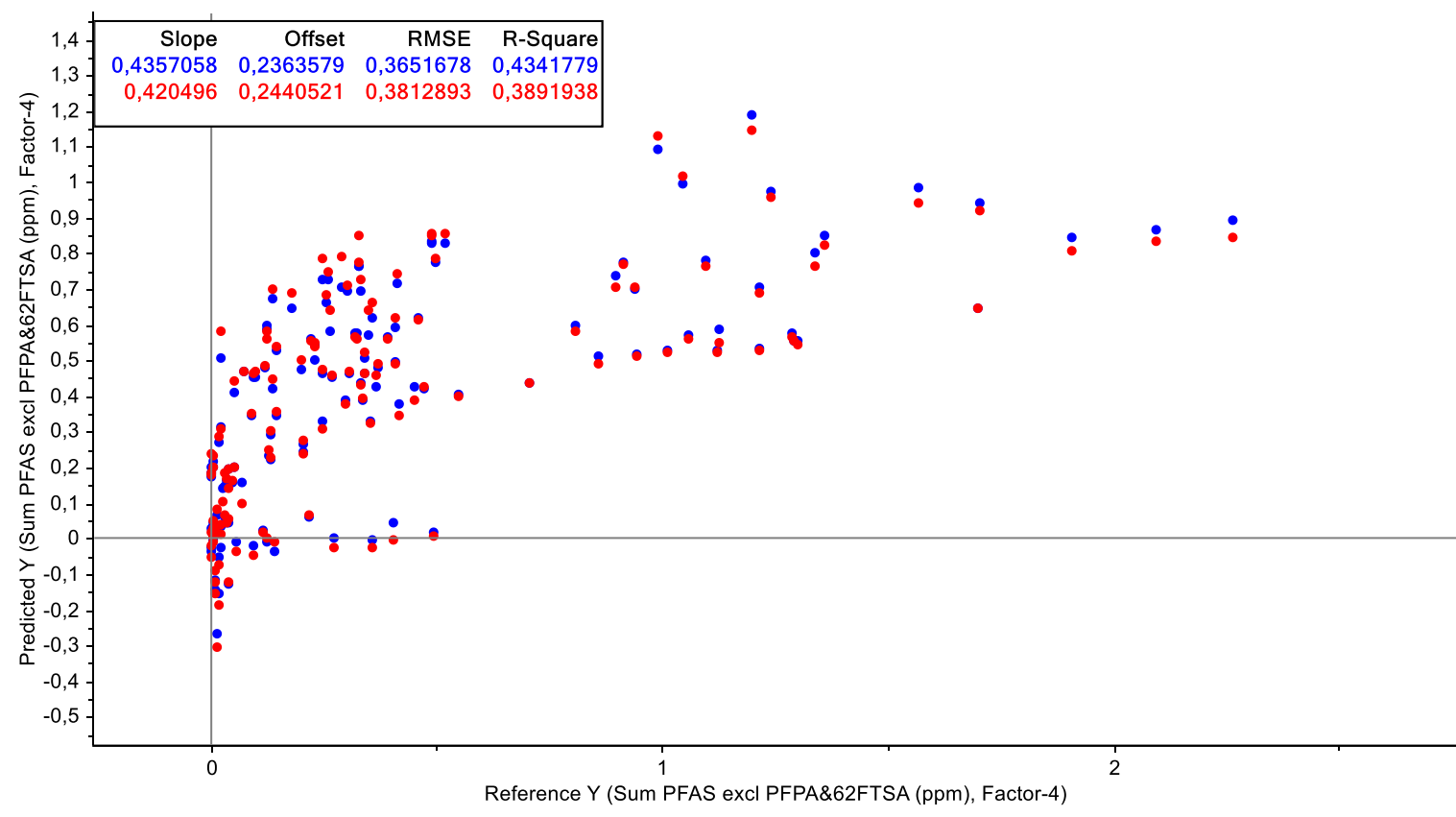

# APPENDIX 4. – ACQUISITION METHOD REPORT FOR LC-MS

## Acquisition Method Report



### Acquisition Method Info

**Method Name** PFAS 090622 1µl kortere metode.m  
**Method Path** D:\MassHunter\methods\MT-lab\PFAS 090622 1µl kortere metode.m

**Method Description**

**Device List**  
 QQQ

**MS QQQ Mass Spectrometer**

**Ion Source** AJS ESI **Tune File** D:\MassHunter\Tune\QQQ\G6495C\  
**Stop Mode** No Limit/As Pump **Stop Time (min)** No limit  
**Time Filter** On **Time Filter Width (min)** 0.07  
**LC->Waste Pre Row** N/A **LC->Waste Post Row** N/A

**Time Segments**

Index	Start Time (min)	Scan Type	Ion Mode	Div Valve	Delta EMV (-)	Store	Cycle Time (ms)	Triggered?	MRM Repeats
1	0	DynamicMRM	ESI+Agilent Jet Stream	To MS	400	Yes	700	No	3

**Time Segment 1**

**Scan Segments**

Cpd Group	Cpd Name	ISTD?	Prec Ion	MS1 Res	Prod Ion	MS2 Res	Frag (V)	CE (V)	Cell Acc (V)	Ret Time	Ret Window	Polarity
	11Cl-	No	631	Unit/Enh	450.9	Unit/Enh	166	32	4	4	1.5	Negative
	11Cl-	No	631	Unit/Enh	83	Unit/Enh	166	32	4	4	1.5	Negative
	6 2FTSA	No	427	Unit/Enh	406.9	Unit/Enh	166	28	4	4	1.5	Negative
	6 2FTSA	No	427	Unit/Enh	81	Unit/Enh	166	40	4	4	1.5	Negative
	9Cl-PF30Ns	No	531	Unit/Enh	350.9	Unit/Enh	166	28	4	4	1.5	Negative
	9Cl-PF30Ns	No	531	Unit/Enh	83	Unit/Enh	166	28	4	4	1.5	Negative
	d3-N-	No	515	Unit/Enh	169	Unit/Enh	166	36	4	6.57	1.5	Negative
	d9-N-	No	639	Unit/Enh	59.1	Unit/Enh	166	16	4	5.8	1.5	Negative
	FOSA	No	498	Unit/Enh	78	Unit/Enh	166	40	4	3.86	1.5	Negative
	FOSA	No	498	Unit/Enh	64	Unit/Enh	166	60	4	3.86	1.5	Negative
	HFPO-DA	No	285	Unit/Enh	168.9	Unit/Enh	166	4	4	3.16	1.5	Negative
	L-PFOS	No	499	Unit/Enh	98.9	Unit/Enh	166	48	4	3.42	1.5	Negative
	L-PFOS	No	499	Unit/Enh	80	Unit/Enh	166	52	4	3.42	1.5	Negative
	M3PFBA	No	216	Unit/Enh	172	Unit/Enh	166	8	4	0.79	1.5	Negative
	M4PFHpA	No	367	Unit/Enh	322	Unit/Enh	166	8	4	2.85	1.5	Negative
	M4PFOS	No	503	Unit/Enh	80	Unit/Enh	166	50	4	3.42	1.5	Negative
	M5PFHxA	No	318	Unit/Enh	273	Unit/Enh	166	8	4	2.29	1.5	Negative
	M8FOSA	No	506	Unit/Enh	78	Unit/Enh	166	60	4	3.86	1.5	Negative
	MPFDA	No	515	Unit/Enh	470	Unit/Enh	166	8	4	3.63	1.5	Negative
	MPFDoDA	No	615	Unit/Enh	570	Unit/Enh	166	8	4	3.92	1.5	Negative
	MPFHxS	No	403	Unit/Enh	84	Unit/Enh	166	49	4	2.87	1.5	Negative
	MPFNA	No	468	Unit/Enh	423	Unit/Enh	166	4	4	3.44	1.5	Negative
	MPFOA	No	417	Unit/Enh	372.1	Unit/Enh	166	0	4	3.19	1.5	Negative
	MPFUdA	No	565	Unit/Enh	520	Unit/Enh	166	8	4	3.79	1.5	Negative
	NaDONA	No	377	Unit/Enh	250.9	Unit/Enh	166	8	4	4	1.5	Negative
	NaDONA	No	377	Unit/Enh	85	Unit/Enh	166	36	4	4	1.5	Negative
	N-EtFOSA	No	526	Unit/Enh	218.9	Unit/Enh	166	28	4	4.2	1.5	Negative
	N-EtFOSA	No	526	Unit/Enh	168.9	Unit/Enh	166	28	4	4.2	1.5	Negative
	N-EtFOSE	No	630	Unit/Enh	59.1	Unit/Enh	166	16	4	4.18	1.5	Negative

N-MeFOSA	No	512	Unit/Enh	218.9	Unit/Enh	166	28	4	4.11	1.5	Negative
N-MeFOSA	No	512	Unit/Enh	168.9	Unit/Enh	166	28	4	4.11	1.5	Negative
N-MeFOSE	No	616	Unit/Enh	59.1	Unit/Enh	166	12	4	4.1	1.5	Negative
PFBA	No	213	Unit/Enh	169	Unit/Enh	166	8	4	0.79	1.5	Negative
PFBS	No	299	Unit/Enh	98.9	Unit/Enh	166	36	4	1.5	1.5	Negative
PFBS	No	299	Unit/Enh	83	Unit/Enh	166	32	4	1.5	1.5	Negative
PFBS	No	299	Unit/Enh	80	Unit/Enh	166	36	4	1.5	1.5	Negative
PFDA	No	513	Unit/Enh	468.9	Unit/Enh	166	8	4	3.63	1.5	Negative
PFDA	No	513	Unit/Enh	218.9	Unit/Enh	166	16	4	3.63	1.5	Negative
PFDODA	No	613	Unit/Enh	568.9	Unit/Enh	166	8	4	3.92	1.5	Negative
PFDODA	No	613	Unit/Enh	168.9	Unit/Enh	166	24	4	3.92	1.5	Negative
PFHpA	No	363	Unit/Enh	318.9	Unit/Enh	166	8	4	2.85	1.5	Negative
PFHpA	No	363	Unit/Enh	168.9	Unit/Enh	166	16	4	2.85	1.5	Negative
PFHxA	No	313	Unit/Enh	268.9	Unit/Enh	166	8	4	2.29	1.5	Negative
PFHxA	No	313	Unit/Enh	119	Unit/Enh	166	22	4	2.29	1.5	Negative
PFHxS	No	398.9	Unit/Enh	119	Unit/Enh	166	42	4	2.87	1.5	Negative
PFHxS	No	398.9	Unit/Enh	98.9	Unit/Enh	166	36	4	2.87	1.5	Negative
PFHxS	No	398.9	Unit/Enh	80	Unit/Enh	166	52	4	2.87	1.5	Negative
PFNA	No	463	Unit/Enh	418.9	Unit/Enh	166	8	4	3.44	1.5	Negative
PFNA	No	463	Unit/Enh	219	Unit/Enh	166	10	4	3.44	1.5	Negative
PFOA	No	413	Unit/Enh	368.9	Unit/Enh	166	8	4	3.19	1.5	Negative
PFOA	No	413	Unit/Enh	168.9	Unit/Enh	166	20	4	3.19	1.5	Negative
PFPeA	No	263	Unit/Enh	219	Unit/Enh	166	6	4	1.38	1.5	Negative
PFTeDA	No	712.9	Unit/Enh	668.8	Unit/Enh	166	16	4	4.12	1.5	Negative
PFTeDA	No	712.9	Unit/Enh	318.9	Unit/Enh	166	24	4	4.12	1.5	Negative
PFTDA	No	663	Unit/Enh	618.8	Unit/Enh	166	12	4	4.03	1.5	Negative
PFTDA	No	663	Unit/Enh	319	Unit/Enh	166	24	4	4.03	1.5	Negative
PFUnDA	No	563	Unit/Enh	518.9	Unit/Enh	166	8	4	3.79	1.5	Negative
PFUnDA	No	563	Unit/Enh	268.9	Unit/Enh	166	20	4	3.79	1.5	Negative

#### Source Parameters

Parameter	Value (+)	Value (-)
Gas Temp (°C)	120	120
Gas Flow (l/min)	13	13
Nebulizer (psi)	30	30
Sheath Gas Temp (°C)	350	350
Sheath Gas Flow (l/min)	11	11
Capillary (V)	3000	3000
Nozzle Voltage/Charging (V)	1500	0

#### Scan Parameters

Data Stg	Threshold
Centroid	0

#### Ion Funnel Parameters

Pos High Pressure RF	150	Neg High Pressure RF	90
Pos Low Pressure RF	60	Neg Low Pressure RF	60

#### Chromatograms

Chrom Type	Label	Offset	Y-Range
MRM	MRM	0	1000
TIC	TIC	0	10000000

#### Instrument Curves

Actual

## APPENDIX 5. – PERISTALTIC PUMP CALIBRATION

Calibration was done with the internal calibration setting on the pump and tested three times for between 0,5-1 minute depending on the flowrate, except from the lowest flowrate which was done over 5 minutes instead. Average flow and standard deviation are presented in Table 16.

TABLE 16 – CALIBRATION OF THE PERISTALTIC PUMP.

	mL/min	% off
Calibration 500 mL/min	501,29	0,26
	497,58	-0,48
	496,37	-0,73
Average mL/min	498,41	
Standard deviation (ml)	2,56	
Standard deviation (%)	0,51	
Calibration 1000 mL/min	999,82	-0,02
	999,71	-0,03
	1000,30	0,03
Average mL/min	999,94	
Standard deviation (ml)	0,31	
Standard deviation (%)	0,03	
Calibration 1500 mL/min	1501,80	0,12
	1498,00	-0,13
	1497,00	-0,20
Average mL/min	1498,93	
Standard deviation (ml)	2,53	
Standard deviation (%)	0,17	
Calibration 1841 mL/min	1826,00	-0,81
	1831,00	-0,54
	1839,00	-0,11
Average mL/min	1832,00	
Standard deviation (ml)	6,56	
Standard deviation (%)	0,36	
Calibration 159,1 mL/min	158,32	-0,49
Average mL/min	158,32	
Standard deviation (ml)	#DIV/0!	
Standard deviation (%)	#DIV/0!	

## APPENDIX 6. – DESIGN EXPERT BUILD REPORT

### Build Information

File Version 13.0.9.0  
Study Type Response Surface Subtype Randomized  
Design Type Central Composite Runs 20  
Design Model Quadratic Blocks No Blocks

### Factors

Factor	Name	Units	Type	SubType	Minimum	Maximum	Coded Low	Coded High	Mean	Std. Dev.
A	Flow rate	L/min	Numeric	Continuous	0,1591	1,84	-1 ↔ 0,50	+1 ↔ 1,50	1,0000	0,4239
B	Current density	mA/cm2	Numeric	Continuous	32,39	242,61	-1 ↔ 75,00	+1 ↔ 200,00	137,50	52,99
C	Initial concentration PFAS	ppm	Numeric	Continuous	0,0202	0,5200	-1 ↔ 0,30	+1 ↔ 1,00	0,2584	0,1361

### Responses

Response	Name	Units	Observations	Minimum	Maximum	Mean	Std. Dev.	Ratio
R1	Residual concentration PFAS	ppm	20,00	0,00134588	0,490798	0,0936	0,1420	364,67
R2	UV254	abs	20,00	0,0083	0,1114	0,0699	0,0294	13,42





**Norges miljø- og biovitenskapelige universitet**  
Noregs miljø- og biovitenskapelige universitet  
Norwegian University of Life Sciences

Postboks 5003  
NO-1432 Ås  
Norway