

L  
(481)N

# Norwegian Journal of Agricultural Sciences

Supplement No. 1 1987 – Revised edition

Olav Grøterud

5 MARS 1990

Lake acidification –  
a complex phenomenon elucidated  
by studies of fifteen lakes  
in Finnemarka, Southern Norway



Norsk institutt for skogforskning  
Biblioteket  
Postboks 61 - 1432 ÅS-NLH

Norwegian Agricultural Advisory Centre, Ås, Norway

## NORWEGIAN JOURNAL OF AGRICULTURAL SCIENCES

*Norwegian Journal of Agricultural Sciences fills a need created by the folding of Scientific Reports of the Agricultural University of Norway and Research in Norwegian Agriculture for a forum for publishing Norwegian research with international interest within the following areas: Aquaculture, Animal Science, Soil Science, Agricultural Engineering and Technology, Natural Resources and Environment, Food Technology, Crop Science, Forestry, Economics and Society Planning.*

Managing Editor Jan A. Breian

### Subject Editors

Even Bratberg, Rolf Enge, Ketil Gravir,  
Unni Dahl Grue, Knut Heie, Arne Hermansen,

Atle Kvåle, Fridtjov Sannan, Trygve Skjevvald,  
Jon Stene, Steinar Tveitnes

### Editorial Board

Åshild Krogdahl, Institute of Aquacultural Research  
Ragnar Salte, Institute of Agricultural Research  
Odd Vangen, Agricultural University of Norway, Department of Animal Science  
Toralf Matre, Agricultural University of Norway, Department of Animal Science  
Anders Skrede, Agricultural University of Norway, Department of Animal Science  
Ole Øivind Hvatum, Agricultural University of Norway, Department of Soil Science  
Ådne Håland, Særheim Research Station  
Sigmund Christensen, Agricultural University of Norway, Department of Farm Power and Machinery  
Karl Alf Løken, Agricultural University of Norway, Department of Building Technology in Agriculture  
Einar Myhr, Agricultural University of Norway, Department of Agricultural Hydrotechnics  
Geir Tutturen, Norwegian Institute of Agricultural Engineering  
Sigmund Huse, Agricultural University of Norway, Department of Conservation and Management of Natural Resources

Hans Staaland, Agricultural University of Norway, Department of Zoology  
Grete Skrede, Norwegian Food Research Institute  
Kjell Steinholt, Agricultural University of Norway, Department of Dairy and Food Industries  
Arne H. Strand, Agricultural University of Norway, Department of Dairy and Food Industries  
Arne Oddvar Skjelvåg, Agricultural University of Norway, Department of Crop Science  
Sigbjørn Vestrheim, Agricultural University of Norway, Department of Horticulture  
Birger Halvorsen, Norwegian Forest Research Institute  
Martin Sandvik, Norwegian Forest Research Institute  
Asbjørn Svendsrud, Agricultural University of Norway, Department of Forest Economy  
Kjell Bjarte Ringøy, Norwegian Agricultural Economics Research Institute  
Hans Sevattal, Agricultural University of Norway, Department of Land Use Planning  
Kåre Årsvoll, Norwegian Plant Protection Institute

### PUBLISHER

The journal is published by Norwegian Agricultural Advisory Centre, Moerveien 12, N-1430 Ås, Norway. Norwegian Journal of Agricultural Sciences (ISSN 0801-5341) is published four times a year, each issue containing approximately 100 pages. Four issues comprise one volume. Annual subscription NOK 400,-. Subscribers receive supplement issues free of charge, but these can also be ordered separately through the publisher.

### CORRESPONDENCE

All Correspondence, editorial or otherwise, should be addressed to Norwegian Agricultural Advisory Centre.

The drawing on the cover is from Kjell Aukrust's «Guttene på broen».

**ISSN 0801-5341**

5 MARS 1990

**LAKE ACIDIFICATION - A COMPLEX  
PHENOMENON ELUCIDATED BY STUDIES OF  
FIFTEEN LAKES IN FINNEMARKA,  
SOUTHERN NORWAY**

By  
**Olav Grøterud**

*Forest institutt for skogforskning  
Eskdalestet  
22 61 - 1402 AS-MLH*

Agricultural University of Norway,

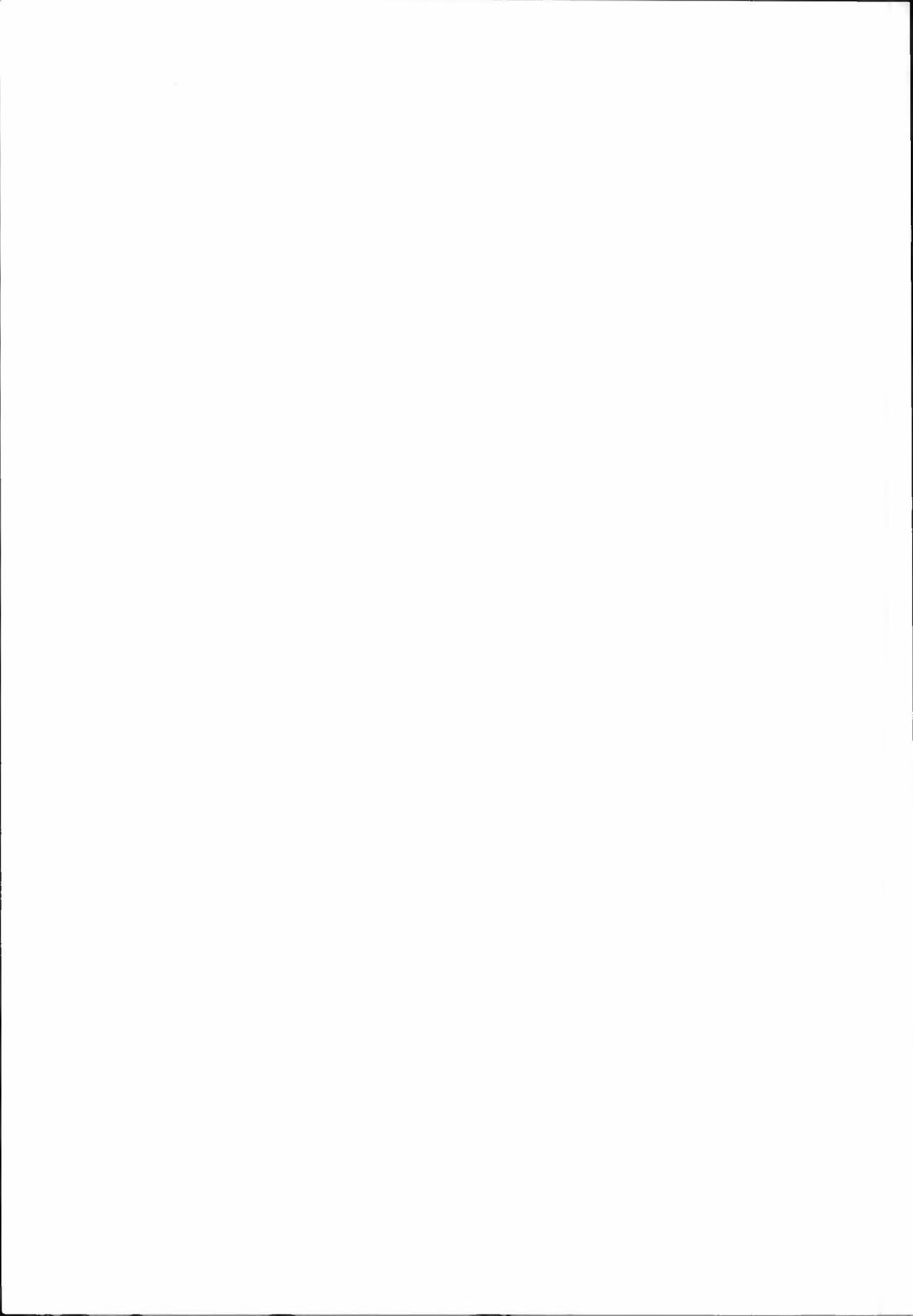

## CONTENTS

I. INTRODUCTION .....	7
1. Transformation and transportation of substances in catchments .....	7
2. Processes in lakes .....	7
3. The sulphur and nitrogen cycles in a catchment .....	9
4. Input - output of substances .....	9
5. Reasons for water acidification .....	9
II. MATERIALS AND METHODS .....	13
1. Field work .....	13
2. Laboratory work .....	17
III. DESCRIPTION OF THE AREA AND THE LAKES STUDIED .....	21
1. Situation .....	21
2. Morphology .....	21
3. Geology .....	21
4. Soil .....	21
5. Vegetation .....	23
6. Activities .....	24
7. Hypsography .....	24
8. Climate .....	32
9. Chemistry of precipitation, snow and ice profiles .....	35
10. Minicatchments and micro- drainage .....	40
11. Water quality and lake ecology .....	42
IV. HYDROLOGY .....	51
1. Precipitation measurements and estimations .....	51
2. Runoff measurements and estimations .....	53
3. Evapotranspiration measurements and estimations .....	61
4. Water balance and hydraulic retention time and loading .....	63
V. FIELD AND LABORATORY EXPERIMENTS .....	65
1. Addition of NaOH and ice to minicatchments .....	65
2. Laboratory lysimeter experiments .....	66
3. Laboratory experiments with undisturbed water- sediment cores .....	67
4. Storing of stones in distilled water and storing of percolation water .....	68
5. Water boatmen ( <i>Corixidae</i> ) in the laboratory .....	71
6. Lake fertilizing .....	71
VI. LAKE WATER CHEMISTRY .....	73

VII. LAKE RETENTION OF SUBSTANCES .....	79
1. Input - output measurements and calculations .....	79
a) Substance retention in relation to hydraulic loading, substance loading and hydraulic retention time .....	80
b) General input- output model .....	115
2. Sedimentation trap measurements .....	118
a) Trap measurements in relation to hydraulic loading and retention time .....	120
b) Trap measurements in relation to the ratio the terrestrial catchment- lake area .....	120
c) Trap measurements in relation to relative depth and catchment drainage potential .....	123
VIII. LAKE SEDIMENT ANALYSES .....	125
1. Sedimentation rates recorded by sand marking and lead analyses .....	125
2. Sedimentation rates calculated by sedimentation trap measure- ments and sediment dating by sand marking .....	127
3. Determination of sedimentary chlorophyll and the $E_{410}/E_{350}$ .....	127
4. Determination of $H_2O$ , IL (organic matter), pH, $E_h$ , N, S, Al, Fe, Mn, Ca, P, Si (alkaline-soluble), N/S and IL/N .....	129
a) The Finnemarka lakes .....	130
b) The reference lakes .....	142
c) Lake comparisons .....	144
5. Lake retention in relation to recent sedimentation .....	151
IX. ALKALINITY BUDGETS CALCULATED ON THE BASIS OF MEASURED LAKE RETENTIONS FOR IMPORTANT IONS .....	153
X A. MODIFIED VOLLENWEIDER MODEL APPLIED TO THE LAKES .....	155
1. Phosphorus .....	155
2. Hydronium .....	159
XI. TENTATIVE CONCEPTUAL MODEL OF HUMIC MATTER TRANSFORMATION IN THE LAKES .....	161
XII. THE DYNAMICS OF ACIDIFICATION INDICATED BY A CONCEPTUAL MODEL .....	163
XIII. CONCLUDING REMARKS .....	167
XIV. SUMMARY .....	169
XV. ACKNOWLEDGEMENTS .....	171
XVI. REFERENCES .....	173

## ABSTRACT

The hydrology and lake chemistry of 14 acid and 1 neutral lakes, more or less influenced by humic matter, have been investigated as a basis for evaluation of the acidification dynamics. The runoff values from the lakes have shown a close relationship to the precipitation values measured at a permanent meteorological station in the lowland nearby. A correlation matrix indicates a close connection between important lake water parameters, and multiple correlation analyses by stepwise procedure have given some regression models, e.g.  $\text{pH} = 6.180 - 0.017\text{SO}_4 + 0.007\text{Ca}$ , with  $r^2 = 0.895$ . The lake acidification has been divided into three main types: atmospheric, terrestrial and limnic acidification. The acid lakes have small sources of geological alkalinity, and consequently other forms of alkalinity production have shown to be of importance. One such form is the alkalinity produced biologically by chemotrophic bacteria and photosynthetic organisms reducing  $\text{SO}_4$  and  $\text{NO}_3$ . In addition, some unknown forms of alkalinity production may have taken place in most lakes according to the alkalinity budgets calculated, apparently involving neutralization of some humic acids. Alkalinity production has been shown to contribute to the acid-neutralizing ability of the lakes, and changes may be of crucial importance to the limnic part of the acidification dynamics. There is reason to believe that decreased nutrient (P) supply to the lakes in recent years has resulted in less primary production, and subsequently, decreased reduction of  $\text{SO}_4$  and  $\text{NO}_3$  in the lake sediments. Estimation of the P change necessary for a significant change in primary production has been done by means of a modified Vollenweider model. A conceptual model of lake acidification is given at the end of this study on the basis of hypotheses and research results.

**Key words:** runoff, hydraulic loading and retention time, acid precipitation, biogeochemical acid production, limnic alkalinity production,  $\text{H}_2\text{SO}_4$ ,  $\text{HNO}_3$ , humic acids, reducing power, substance retention, sediment analyses, modified Vollenweider model, oligotrophication.

## PREFACE

Such a comprehensive and complex research work should normally have been done by many interdisciplinary scientists, but due to financial limitations and coincidences the author has accomplished the project alone. This has led to relatively modest results in parts of the project. However, it seems to have been easier to coordinate the different parts of the study by working alone.

Some results have previously been partly published, and the present research report is the final paper from the project. The manuscript was already finished, when an international symposium on «Acidification and Water Pathways» was held at Bolkesjø, Norway 4 - 8 May 1987, and the results from this symposium have therefore not been included in the discussions.

When the first published edition was handed in to a scientific committee for evaluation many misprints were discovered. In addition, some weak points and a need for some newer references were indicated. Consequently, this edition represents an amendment of the first one.

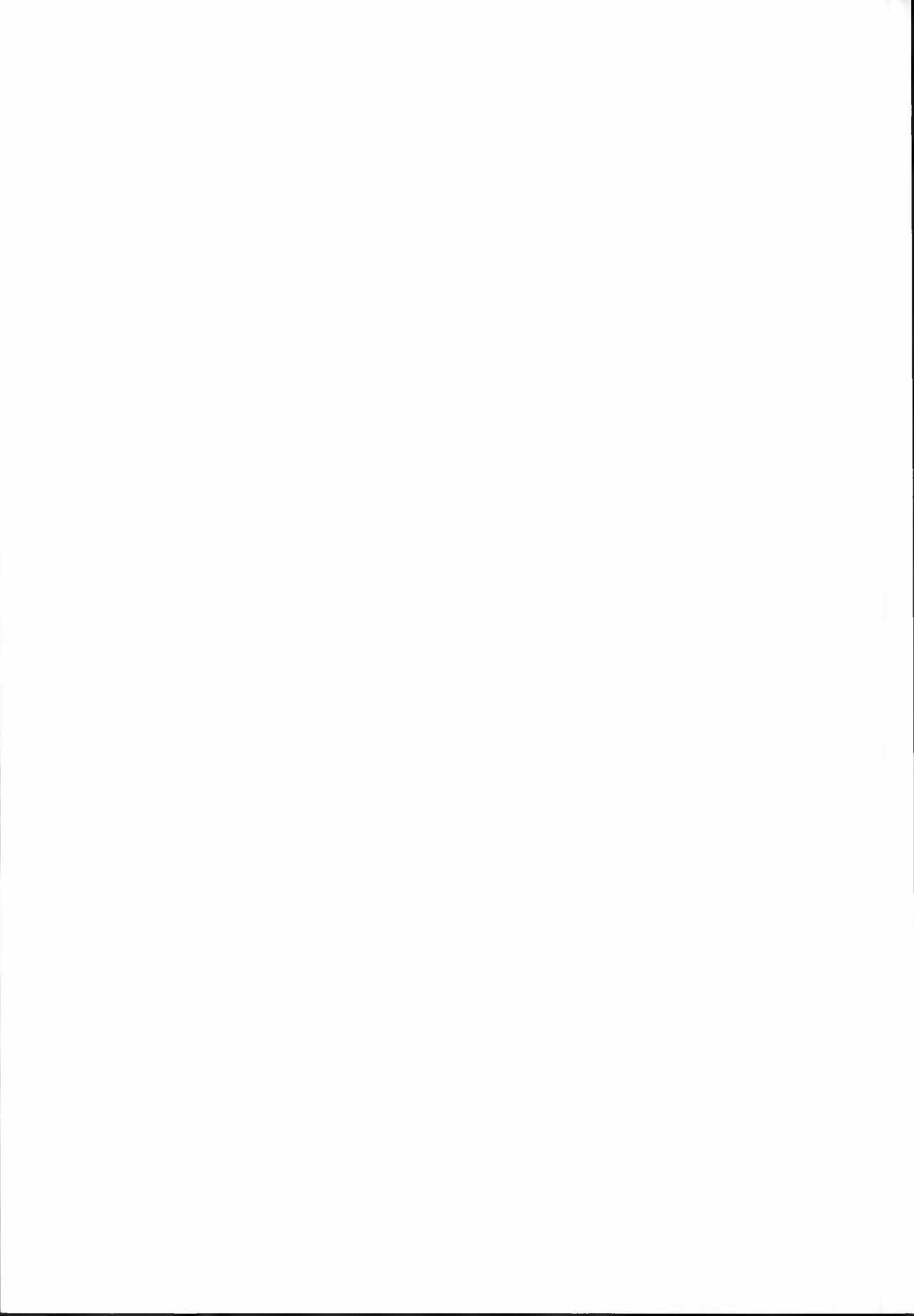



## I. INTRODUCTION

A previous theoretical consideration (Grøterud 1985) has been partially incorporated in the present introduction.

### 1. Transformation and transportation of substances in catchments

Transformation and transportation of wet and dry fallout in a catchment are governed by the physiography (geology, vegetation, overburden, topography etc.), climate and hydrology. The main amount of precipitation falls first on the vegetation, soils and rocks and is accordingly exposed to many chemical and biological processes before reaching rivers and lakes. This water, together with the precipitation falling directly into rivers and lakes, is subsequently affected by different limnic processes.

Like water, the substances in water have their cycles in nature. These cycles usually deviate from the hydrological cycle. When water is evaporating, the concentration in the remaining water increases. Substances can be contributed through chemical weathering in the catchment. Furthermore substances can be deposited from the water and accumulate for a short or a very long time. Even if substances are not supplied or deposited, the transportation cycles will nonetheless deviate from that water. This is due to ion exchange and adsorption. The land vegetation also changes the precipitation quality by secreting and absorbing substances.

Furthermore, the top soil (root zone), with its horizontal stratification, is clearly characterized by different chemical and biological processes taking place together with the water percolation. In deeper strata the chemical processes are no longer connected to the biological ones. Here the ground water is usually found, and mainly purely chemical processes (chemical weathering) occur in this environment. This ground water can later become surface water and on its way very often has to pass the top soil again with its special influence. When the ground water is exposed to the atmosphere, gas exchange determines the concentrations of oxygen and  $\text{CO}_2$  in the water. Furthermore, the influx of light initiates different biological processes in the water. These limnic processes may partly be conditioned by the composition of the incoming ground water. The water is, as pointed out, affected by different pH buffer systems on its way through a catchment. The effect of the buffer systems is dependent on the bedrock, soil, climate, vegetation and limnological status of the water reservoirs. The ability of the ecosystem to neutralize acid components in the wet and dry fallout is thus conditioned by many factors, perhaps in particular the mineral composition of the bedrock and the loose deposits, the vegetation and the trophic status of the lakes.

### 2. Processes in lakes

There are two main transport systems for substances and energy in lakes, a vertical one between the surface and the sediments and a horizontal one in and out of the basin. During summer and winter many lakes are thermally stratified (depending among other things on depth and wind exposition). The horizontal transport can thus be somewhat strengthened. Fig. 1 gives a schematic outline of the main elements affecting these transport systems.

Physical, chemical and biological processes in a lake may be able to change the inflowing water quality rather significantly after a certain water retention time. The intensity of the processes in question is mainly dependent on the trophic status of the lake and the climate. With respect to the transformation of acidifying substances, the

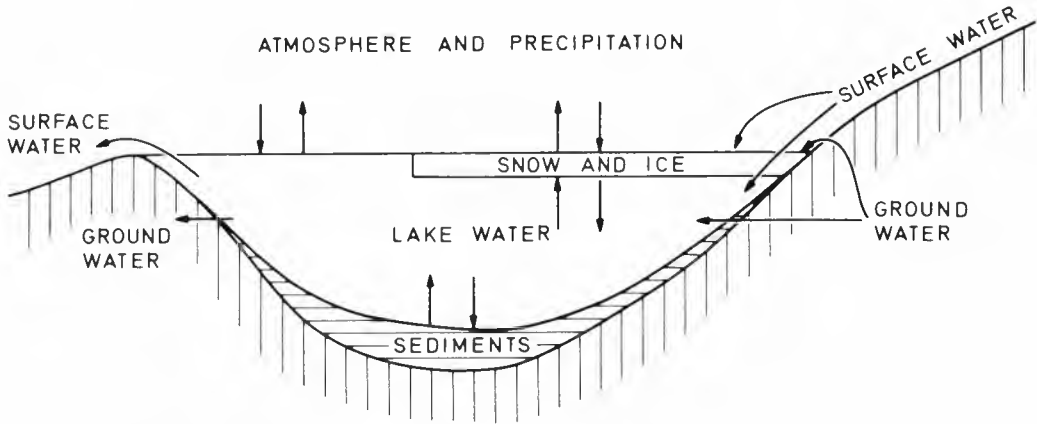

Fig. 1. The main elements in a schematic outline of the transportation of substances and energy in a lake.

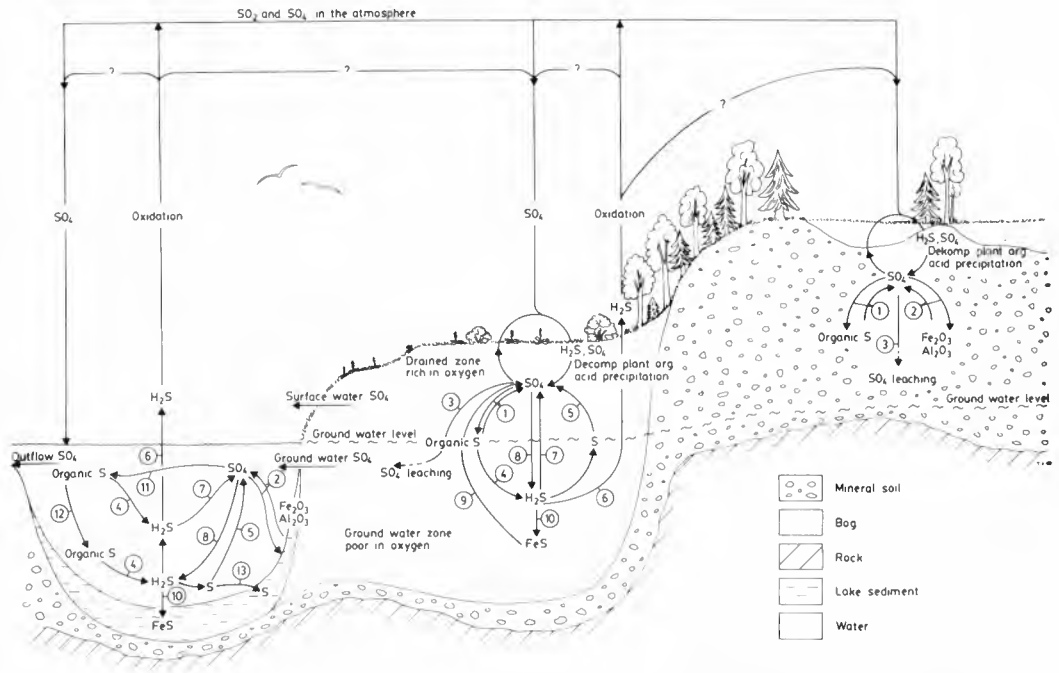

Fig. 2. The sulphur cycles in a catchment with mineral soils, bogs and lakes: 1. sorption and release of  $\text{SO}_4$  by soil animals and microorganisms; 2. sorption and desorption of  $\text{SO}_4$  by iron and aluminium oxides; 3. leaching of  $\text{SO}_4$ ; 4. release of  $\text{H}_2\text{S}$  by decomposition of animals and microorganisms; 5. oxidation of  $\text{H}_2\text{S}$  to  $\text{SO}_4$  via elemental sulphur by chemical processes and bacteria; 6. gas loss of volatile sulphides to the atmosphere; 7. oxidation of  $\text{H}_2\text{S}$  to  $\text{SO}_4$ ; 8. reduction of  $\text{SO}_4$  to  $\text{H}_2\text{S}$ ; 9. oxidation of  $\text{FeS}$  to  $\text{SO}_4$ ; 10. chemical precipitation and deposition of  $\text{FeS}$  in soils and lake sediments; 11. uptake of  $\text{SO}_4$  by algae; 12. sedimentation of organic sulphur (algae); 13. deposition of elemental sulphur in lake sediments. Modified after Grøterud (1985).

most important processes are assumed to be adsorption and ion exchange of hydronium by metal ions (Ca, Mg), bacterial reduction and algal absorption of  $\text{SO}_4$  and  $\text{NO}_3$  (Kilham 1982, Kelly et al. 1982) and decomposition of acid humic substances (fulvic acids, humin acids). The sediments are being focussed on in this regard (Hongve 1978, Grøterud & Hongve 1980).

### 3. The sulphur and nitrogen cycles in a catchment

Sulphur is supposed to be a key element in the acidification dynamics. Therefore it may be of interest to study its cycles in a catchment with mineral soils, bogs and lakes. Wetzel (1975), Grøterud & Hongve (1980) and Brække (1982) have given important contributions to the understanding of this phenomenon. Fig. 2 summarizes these contributions. To simplify the figure, the long term formation of organic S and  $\text{FeS}_2$  from  $\text{H}_2\text{S}$  and FeS (Rudd et al. 1986) has not been taken into account. Nitrogen is also an important element regarding acidification and has cycles with some resemblance to sulphur's. However, unlike sulphur, nitrogen cannot be adsorbed to metal oxides or precipitated by metals. In addition nitrogen is very often a limiting factor for plants, in contrast to sulphur, which is seldom in minimum. Otherwise they have both a volatile phase ( $\text{H}_2\text{S}$ ,  $\text{N}_2$ ) in the redox processes which can ensure recycling to the atmosphere.

### 4. Input - output of substances

Seip (1980) has given a schematic illustration of the transport and transformation of important ions in a catchment (terrestrial system), inspired by Rosenqvist (1977). The most conspicuous points in this illustration are the great production and consumption of hydronium, the sorption of  $\text{NO}_3$  and  $\text{NH}_4$ , and the leaching of  $\text{HCO}_3$ , organic anions, Al, Ca and Mg.

A similar illustration for a limnic system has been made in this report (Fig. 93).

In this connection it is interesting to mention a thoroughly and comprehensive study of the input-output considerations of different components in the Swedish lake Gårdsjön (Anderson & Olsson 1985) and Schnoor & Stumm (1985), who have treated the alkalinity balances in aquatic and terrestrial systems.

### 5. Reasons for water acidification

There has been an intense discussion of the reasons for water acidification in Norway during the last 10 years. A brief summary of these is given here.

*The titration model:* The most commonly accepted belief is that acid precipitation runs into brooks, rivers and lakes and acidifies the water. This process is considered to be a large scale titration (Henriksen 1980) and the effect of the precipitation in a catchment is compared to acid titration of a hydrogen carbonate solution. Catchments with bedrocks and overburden poor in neutralizing capacity (so-called sensitive area) will have small concentrations of  $\text{HCO}_3$  in the rivers and lakes. After a certain loading with acids ( $\text{H}_2\text{SO}_4$ ), the lakes may be transferred from  $\text{HCO}_3$  lakes to acid sulphate lakes. This consideration is very simple and with certain assumptions useful in a practical connection. But it is badly informing about biogeochemical knowledge and experience. In a pedagogical connection it is also unfortunate, it may convey the impression that nature is a static system with a certain amount of bases, instead of a complex ecosystem which actively takes part in the transformation of supplied substances.

*The Rosenqvist model:* The contrary view, that water acidification is mainly due to changes in the catchment's biogeochemical buffering level, is especially emphasized by Rosenqvist (1977, 1981). He is therefore more concerned about the amount and intensity of the precipitation than its acidity during the acid flood episodes. This has been confirmed by a statistical investigation in a brook near Birkenes in Aust-Agder county, South Norway (Rosenqvist 1977)

Rosenqvist et al. (1980) describe the hydronium runoff in a catchment by means of the following relation:

$$H^+ = A \Sigma \text{anions} + B$$

A and B are constants determined by the soil property and the runoff pattern. Typical values for these constants in Norway are 0.01 - 0.5 for A and  $10^{-8}$  -  $10^{-5}$  mol/l for B (Rosenqvist et al. 1980). High values for  $H^+$  are dependent upon the presence of  $SO_4$ ,  $NO_3$ , Cl and high values for A. The importance of factor A has been investigated in an area where nearly all the vegetation and humus were removed by a forest fire some years ago (Hegna 1986). This project was initiated by Rosenqvist (1981). The preliminary results are not easily explainable, but the lower acidity of the runoff and lake from the burnt catchment compared to the reference catchment may be connected to the removal of the humus by the forest fire (Hegna 1986).

*Other models:* Some scientists explain acidification as a combination of many reasons. They thus act as bridge builders between the first two acidifications models mentioned and in that way make the acidification problem more a question of the various reasons' significance (e.g. Seip 1980, Ulrich 1980, Stuanes 1980, Grøterud 1981, 1984a, Christophersen 1983).

Seip (1980) mentions three main factors governing the pH values in the runoff water from a catchment, namely the concentration of mobile anions (sulphate), the soil property (base saturation) and the runoff pattern. He states that it is difficult at the present time to quantify the various factors' importance for the acidification of rivers and lakes. To clarify the discussion Seip presents three conceptual models; 1. direct effect of the acidic precipitation; 2. increased deposition of mobile anions, primarily  $SO_4$ ; 3. soil acidification caused by a) acid deposition or b) other factors, e.g. changed vegetation. His conclusions so far are as follows (Overrein et al. 1980). Direct effect of the acid precipitation is normally small, but not negligible. Soil acidification due to acid precipitation may occur, but does not seem to explain an essential amount of the observed pH changes in fresh water. Changes in land use of the catchment may contribute to acidification in some cases, but can hardly explain regional acidification. The most reasonable explanation is incorporated in the mobile anion concept, that is, that an increase in  $SO_4$  concentration of the precipitation can explain a great part of the acidification observed.  $NO_3$ , which also will have increased, will be effectively sorbed in the catchments, while Cl will not change significantly. Seip says finally that there is no reason to doubt the changed composition of the precipitation as an important factor in the acidification of fresh water.

The author divides the acidification processes into three main types: atmospheric, terrestrial and limnic (Grøterud 1981, 1984a). The two latter types of acidification processes could be a result of increased acid production, reduced acid consumption or both simultaneously. This can be illustrated by a model (Fig. 3) which shows the relationship

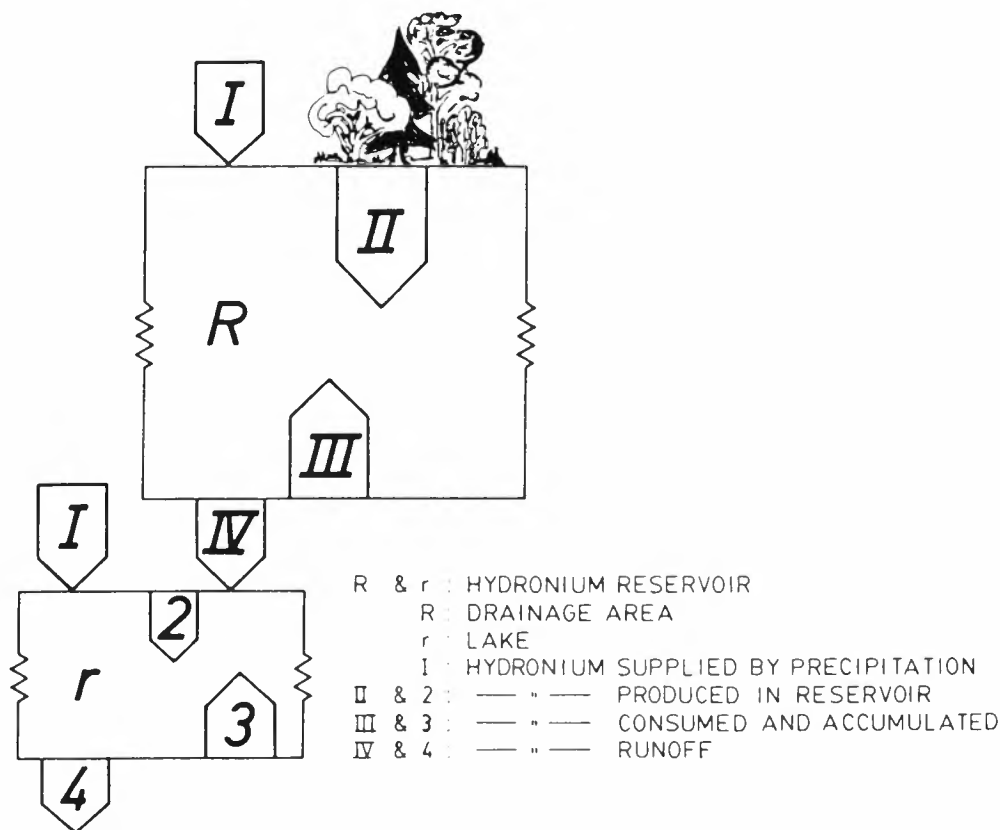

Fig. 3. A model describing the relationship between the different acidifying factors in the lake area. R and Roman numerals denote the terrestrial system, r and Arabic numerals the limnic system. After Grøterud (1981).

between the different acidifying factors in a lake area (Grøterud 1981). This model, which is based on that of Rosenqvist (1977), also attaches importance to the limnic system in the acidification dynamics (Grøterud 1984a). The transformation of substances in a lake ecosystem will more or less buffer the input, and a change in one or more parts of this system could lead to acidification.

The ability or capacity of the lakes to neutralize the acid input from the catchments is assumed to have decreased during the last decades (Grøterud and Hongve 1980). An interesting acid-consuming process, which primarily goes on in the sediments, is the reduction of  $\text{SO}_4$  to  $\text{H}_2\text{S}$ . With Fe present (rather common) and proper pH value ( $> 6$ ) the sulphide may be precipitated as  $\text{FeS}$  in the sediments (see also Rudd et al. 1986). This mechanism can be disturbed by an oligotrophication of the lake by an increase in the redox potential in the bottom water and sediments, e.g. through a decreased P supply from the catchment. A reduced P supply may be due to reduced grazing and associated activities and invasion of heathers, mosses and trees in the catchment (Grøterud 1982a, 1984a).

The intention of this research report has been to put together all papers (Grøterud 1971a, b, 1972a, b, c, 1973, 1978, 1981, 1982 a, b, 1984 a, b, 1985, 1987, Grøterud & Hongve 1980), investigations and studies by the author so far, in the lake area Finne-marka in particular and on acidification in general. The working hypothesis is that the three main types of acidification, atmospheric, terrestrial and limnic, may be of importance and that the quantitative significance will vary from lake to lake. These variations are assumed to be mainly determined by the hypsography (size and shape of the lake basin and the terrestrial catchment), hydrology, soil depth and previous activities in the catchments.

Lake retention and sediment analysis of important components have been relatively thoroughly investigated in this paper. These investigations shall be considered an attempt to throw some light on the lake chemistry and the limnic contribution to acidification dynamics in the past and present.

## II. MATERIALS AND METHODS

### 1. Field work

As the basis of the bathymographical maps, echo sounding has been used in Lakes 4 and 13 and a sounding line through holes in the ice covers in the other lakes.

Water discharge measurements were carried out by the salt dilution method (Østrem 1964, Bjerve & Grøterud 1980), the collection method and the current meter method according to Harlacher (Otnes & Ræstad 1978). The current velocities were determined by an ordinary screw current meter. The water level recordings as the basis of the lake discharge measurements were done by a limnograph in Lakes 2 and 4 and by a pole with a scale in Lakes 3, 5, 6, 7, 8, 12 and 13. The other lakes' water discharges have been calculated on basis of the size of the catchments and measurements in the outlets from Lakes 2 and 4. A survey of the runoff measurements is given in Table 1.

Table 1. A survey of the runoff measurements from different catchments

Year	1970	-71	-72	-73	-74	-75	-76	-77	-78	-79	-80	-81	-82
Lake No.													
2									_____				
3										_____			
4	_____									_____			
5									_____				
6									_____				
7									_____				
8									_____				
12									_____				
13									_____				
Reference catchment									_____				

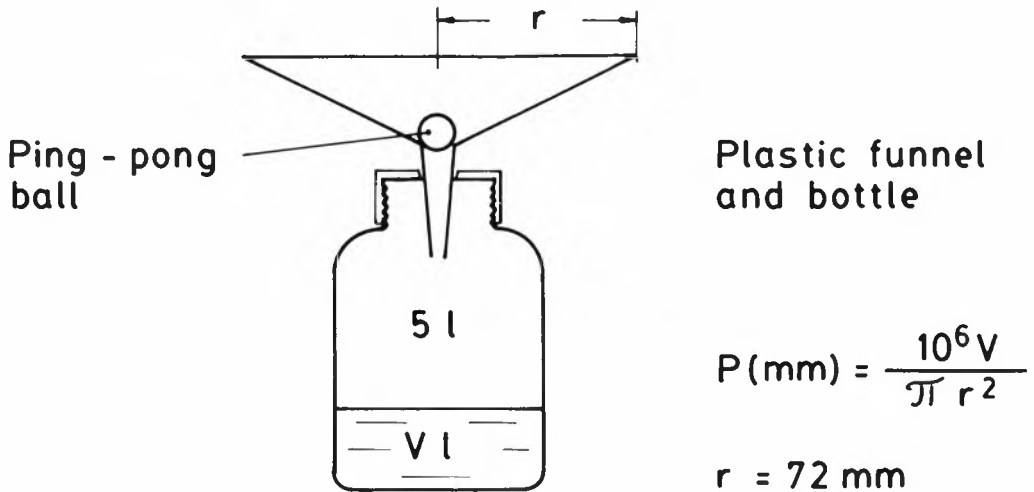
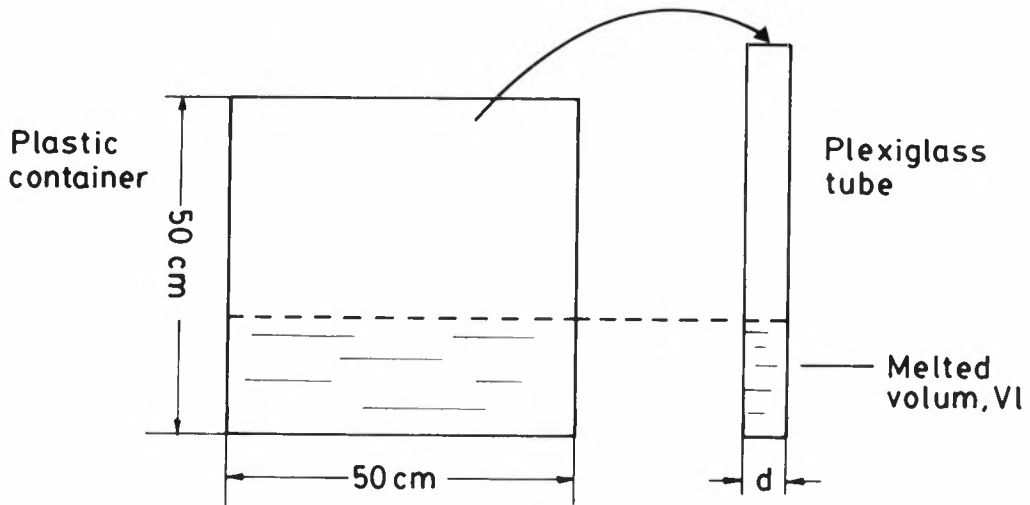

Fig. 4. The rain recorder.

The precipitation measurements were carried out by means of the equipment shown in Fig. 4. The rain recorder was used to collect the wet and dry fall-out. The ping-pong ball prevents evaporation from the bottle, but permits the wet and dry fall-out to be washed into it. By measuring the water volume ( $V$ ) collected in the bottle at appropriate intervals (from a few days up to one month, depending upon the rain intensity and frequency), the precipitation ( $P$  mm) was found using the formula given (Fig. 4). The snow recorder is shown in Fig. 5. Sub-samples were taken from the plastic container for melting and volume measurements by using a plexiglass tube. This volume ( $V$ ) is used to find the precipitation ( $P$  mm) by employing the formula given in the figure. Both the wet and dry fall-out were collected by the snow recorder and no evaporation hindrance was set up as for the rain recorder. However, the evaporation in winter is assumed to be of little importance. Generally, both precipitation recorders are supposed to collect the dry fall-out less efficiently compared with an equal-sized surface area in the terrain (especially covered with vegetation). The precipitation recorders were placed at Lake 4 the first years (1970-75). Later (1976-82), in connection with the establishment of a field laboratory, the recorders were moved to Lake 1. The recorders were located at appropriate sites about 1 m above the ground level. The evaporation recorder was only used at Lake 1 (1978-79). Fig. 6 shows the recorder. Measurements by the same type of recorder have been reported previously (Grøterud 1986). The evaporation values were calculated by the equation described in the figure.

*Minicatchment research.* Minicatchments 1 (ca. 20 m<sup>2</sup>) and 2 (ca. 10 m<sup>2</sup>) were bounded by the natural topography and artificial drainage (small open ditches). The reference catchment (ca. 4000 m<sup>2</sup>) was bounded by the natural topography only. To the snow in minicatchment 1 were added 5 g NaOH in 50 l water (melted snow) by means of a garden sprinkler, 10 times at 15 min. intervals. This amount corresponds to about 28 μmol/l in the snow cover. In catchment 2 the snow was removed and replaced by clear, relatively clean, ice (Grøterud 1978) from Lake 1. The ice was taken by means of a motor-saw. All three catchments lie just south of Lake 1, apart from each other.





$$P \text{ (mm)} = \frac{10^6 V}{\pi (d/2)^2} \quad d = 44 \text{ mm}$$

Fig. 5. The snow recorder.

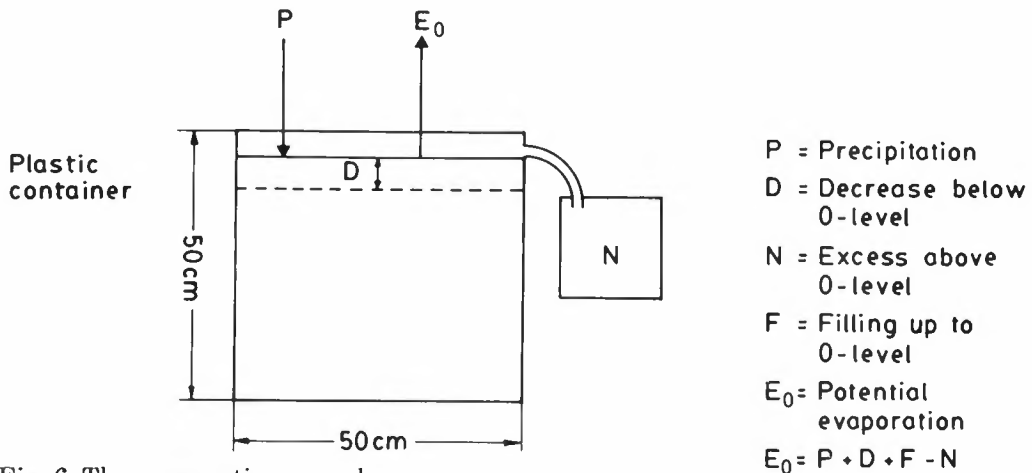

Fig. 6. The evaporation recorder.

*Fertilizing experiment.* Lake 15 was fertilized with 100 ml concentrated  $\text{H}_3\text{PO}_4$  on 11.6.1982. The amount  $\text{H}_3\text{PO}_4$  added to the lake represents about  $40 \mu\text{g P}$  per litre lake water.

*Sedimentation trap measurements,* were done according to Skogheim & Hongve (1979). A pair of traps were placed at the maximum depth about  $1/3 Z_m$  above the bottom for

one year (1980). The traps were emptied every second month and analysed. The average value of the four collecting units (one trap consists of two collecting units) was used as representative for each lake.

*Undisturbed lake sediment cores* were taken by means of a sediment core sampler made at the Department of Hydrotechnics, Agric. Univ. of Norway. It is an open barrel gravity corer with a diameter of 44 mm. The coring was performed with high penetration velocities and the shortning is assumed to be moderate (Hongve & Erlandsen 1979). For the sediment-water interaction experiments sediment cores at maximum and middle depth were used. The chemical analysis of the sediments was done on three sediment cores, taken from  $Z_m$ , and the average value of these results calculated.

*Sediment dating* in Lakes 3, 5, 8 and 13 was done by means of sand marking in the winter of 1972. About 10 kg of sand (0.2-0.6 mm) was put into an ice hole over the maximum depth of the lakes. It is presupposed that the sand particles were retained on the surface of the sediments. This is somewhat uncertain and there is reason to believe that the sand particles will move very slowly with time downward into the sediments, even if laboratory experiments with two undisturbed lake sediment cores from Lake 3 have shown small movements during one year. Sediment cores were taken in the winter of 1982 for determining the position of the sand layers in the lakes' sediments.

*Ice cores for chemical analysis* were taken with a steel drill, specially made for this purpose at the Department of Hydrotechnics. The ice was put into plastic bags.

*Snow cores for chemical analysis* were taken with the same plexiglass tube as for snow recording and put into plastic bags.

*Soil cores for chemical analysis and lysimeter experiments* were taken with an ordinary soil drill and put into plastic bags.

*The rain samples for chemical analysis* were taken from the rain recorder and collected in polyethylene bottles.

*The drainage into the lakes* was sampled differently, depending upon the drainage pattern of the catchments. In the catchments with one or more permanent brooks (Lakes 1, 2, 6, 8, 9, 10, 13 and 14) the stream discharge was measured simultaneously with the sampling for analysis of water quality to weight the different chemical parameters when calculating the average values for a certain period. In the other catchments, with only brooklets in connection with snowmelt or rainfall, the water samples were collected in equal volumes and mixed together before analysing the water quality. To calculate the volume-weighted average values in this case the outlet discharge of the lakes was used. The locations of the main drainage measurements are shown by crosses on the hypsographical maps (Fig. 9). Many other small drainages into the lakes («micro-drainages») were also sampled and analysed during the research period to support the selection of the main drainage sampling stations. Small variations in the water quality within the different catchments were found and consequently no corrections have been done.

*Small water samples* were taken by a pipette. This was done with water upon the lake ice, small water volumes in the brooklets and for sampling micro-drainage during heavy rain or snowmelt.

*The water samples in the lakes* were taken by means of a Ruttner water sampler over the greatest depth.

*The water samples of the lakes' discharge* were taken by a polyethylene bottle on a rod in the middle of the stream about one third of the maximum depth below the water surface. In Lake 9 (the regulated lake) it was necessary to sample the water in the lake just inside the dam before the dam gate was opened at the beginning of the winter. The water level recordings in the lake were used in volume-weighting the parameter values of the lake discharges. The water samples from the drainage, the ice surface and the lakes were, as was the precipitation, stored in polyethylene bottles at 4°C in the dark. An exception to this was the lake water intended for determination of oxygen. The water for these analyses was tapped into stoppered glass bottles. The samples from the precipitation, the drainage and the lakes, destined for measurements of PO<sub>4</sub>, NH<sub>4</sub> and NO<sub>3</sub> + NO<sub>2</sub>, were filtered with a Whatman fiberglass paper GF/C and deep frozen.

*Temperature determinations* were carried out by means of a Ritcher & Wiese deep-sea reversing thermometer and an ordinary thermometer inside the water sampler.

*pH* was determined by a Radiometer pH meter 29 with a combined electrode and the measurements *in situ* by two electrodes, specially made for submergence (Grøterud 1971 b).

*Oxygen* was determined according to the Winkler titration method as described by Gardner (1915-16).

*Plankton sampling* were done by means of two nets (meshes of 20 µm for phytoplankton and 100 µm for zooplankton) and the Ruttner water sampler. The plankton samples were preserved with ethanol (zooplankton) and Lugol's solution (phytoplankton).

Benthic animals were collected by taking sediment samples. The sediments were sampled by a plexiglass tube.

## **2. Laboratory work**

*Experiments.* Leaching of hydronium from soil samples (humus layer) was investigated by a simple lysimeter arrangement. The soil was put into a 1 liter polyethylene bottle, placed upside down. The screw cap was perforated and the bottom of the bottle removed. The simulated rain water was distributed by means of titration equipment.

Interaction processes between water and sediment were investigated on undisturbed water-sediment cores incubated at 4° and 20°C. Turbulence in the water was obtained by air bubbling and by water boatmen (*Corixidae*). The water boatmen move up and down between the sediment and water surface in a relatively regular manner. The sediment surface provides food to the water boatmen and the water surface provides air for refilling the bubble on the water boatmen's abdomens. The respiration system of the water boatmen gives them a wide tolerance with regard to water qualities.

Small stones from the littoral zone in some lakes were put into closed polyethylene boxes with 0.5 l distilled water and incubated for a relatively long time. During the experiment some chemical parameters were analysed, and at the end of the run an examination of the algal species was carried out. For some stones the old water was exchanged with a new portion of distilled water in the plastic boxes and the second experiment started. The stones were washed to remove the algae, developed during the first experiment, before starting the second run.

Soil percolation water was stored in polyethylene bottles for eight months and the change in water quality was then measured. The development of algal species in the water was also examined. Water boatmen (*Corixidae*), which normally occur in great amounts in acid water (Raddum et al. 1979), were put into polyethylene bottles with different water qualities (e.g. distilled water, acid humic water) for some days at 15°C. The water quality changes were recorded during the experiment.

*Biological water and sediment analyses.* Algal species, zooplankton and bottom animals were determined by microscopic examination.

*Chemical water analyses.* Most of these analyses have been described previously (Grøterud 1972 b). *Water colour* was observed by a B.D.H. Lovibond Nessleriser and recorded as mg Pt/l. *Optical density* was measured at 190-320 nm wavelengths by scanning and recorded as absorption. A Perkin Elmer spectrophotometer and a quartz cuvette of 1 cm was employed. *pH* was determined by the same instrument as used in the field. *Conductivity* ( $\kappa_{20}$ ) was determined on a Radiometer conductivity meter and recorded as  $\mu\text{S}/\text{cm}$  at 20°C. *KMnO<sub>4</sub> consumption* was measured as described by Werescagin (1931) and expressed as mg KMnO<sub>4</sub>/l. *Calcium and magnesium* were found by means of calcium hardness and total hardness, determined by EDTA titration. Total hardness and calcium hardness tablets from BDH were used. *Sodium and potassium*, were analysed on a flame photometer (EEL). *Chloride* was determined by potentiometric titration according to the American Public Health Association (1962). A Radiometer pH meter 26 with a combined silver-mercurous sulphate electrode was used. *Sulphate* was found as the difference between the concentration of total strong acid anions and chloride (sometimes also nitrate). Total strong acid salts were determined by ion-exchange procedure according to Mackereth (1963).

The colorimetric analyses mentioned below were based on Golterman (1969). *Reactive silicate* (Si) was determined after reaction with molybdate to a yellow complex and then reduced to a highly coloured blue complex. The formula of the compound of silicon which is determined by this method is not known. The term reactive silicate is used as a convenient description only (Golterman 1969). *Orthophosphate* (PO<sub>4</sub>-P) was measured after reaction with molybdate to a yellow complex, then reduced to a blue complex by means of ascorbic acid. *Total phosphorus* was determined as orthophosphate after wet digestion. *Nitrate* (NO<sub>3</sub> + NO<sub>2</sub>-N) was first reduced to nitrite by means of hydrazine sulphate and catalysed by Cu<sup>2+</sup>, sulphanilamide and N-(1-naphtyl) ethylenediaminedi-HCl were then added and nitrite was measured as a red complex. *Ammonia* (NH<sub>4</sub>-N) and bis-pyrazolone were converted to rubazoic acid, which is pink violet in the presence of chloramine T. *Iron* was, after wet digestion, reduced to ferrous iron and measured as a red complex by adding orthopenanthrolin. *Manganese* was, after wet digestion, reduced to Mn<sup>2+</sup> and then oxidized by means of ammonium-persulphate to the red MnO<sub>4</sub><sup>-</sup>. *Aluminium* was determined as acid-reactive Al and labile Al by the catechol violet-method (Daugan & Wilson 1974). Labile Al is supposed to be the toxic

species and is attached to a cation exchange column on  $\text{Na}^+$ -form (Driscoll et al. 1980). *Chlorophyll a* was measured by filtering 1 l water (Whatman fiberglass paper GF/C), extracting the ground filter by acetone and recording from a spectrophotometer (Strickland & Parsons 1968).

*Sediment analyses.* The sediment cores were split into slices of 1-3 cm thickness in the laboratory. *pH* was determined directly by putting the combined electrode into the sediment samples (slices) and registered on the Radiometer pH meter 29 previously mentioned. *Redox potential* ( $E_h$ ) was measured by the same pH meter and a bright platinum electrode. The potential has also been expressed as  $E_7$ , in which the correction is made for the change in redox at the pH of the sample to a pH 7. A rise of pH of one unit is accompanied by a fall in redox potential of 58 mv at 20° C. *Water content* was measured by drying the sediment at 105°C overnight. *Ignition loss* (IL), used as a measure of organic matter, was determined by heating the dried sediment at 550°C for 2 hours. In these sediment types crystal water is supposed to be the main source of error (see Ran-nem & Hongve 1980). The components mentioned below were measured on the ignition residue after dissolving in 6 N HCl. The main part of these components are supposed to be dissolved (Selmer-Olsen, personal communication). *Calcium, magnesium, iron and manganese* were determined by atomic absorption photometry at the Directorate for Wildlife and Freshwater Fish, Fish Research Division, Ås-NLH. *Sodium and potassium* were measured as for the water analyses. *Phosphorus* was determined as orthophosphate and aluminium as acid-reactive Al in water. The residue after dissolving in 6 N HCl was further boiled with  $\text{Na}_2\text{CO}_3$  in polypropylene tubes for determination of *alkaline-soluble silicate* (Selmer-Olsen, personal communication). There was always a very small residue after this procedure, which probably consists of insoluble rock fragments and minerals. *Nitrogen and sulphur* were determined on the dried sediments at the Chemical Analytical Laboratory, Agricultural University of Norway. *Nitrogen* was, after Kjeldahl digestion, measured colorimetrically by the indophenol method. *Sulphur* was oxidized by adding  $\text{MgNO}_3 + \text{HNO}_3$  and heating to 600°C, dissolved in HCl and determined as  $\text{SO}_4$  turbidimetrically. *Chlorophyll degradation products* were determined in accordance with Vallentyne (1955) and presented as units per gram organic matter, measured as ignition loss (u/gIL). *The light extinction ratio at 410 and 350 mm wavelengths*,  $E_{410} / E_{350}$ , was measured on the acetone extracts.

*Sediment trap analyses.* The particulate matter in the traps was resuspended in the water, filtered with fiberglass papers (Whatman GF/C) and dried at 105°C over night and weighed. These fiberglass papers were stored for further analyses, but were accidentally lost from the laboratory. Therefore no other results exist than the total amount of matter deposited per unit time.

*Soil analyses.* *pH* ( $\text{H}_2\text{O}$ ) was determined on the soil just after the sampling by the same pH meter as for the water samples. Distilled water was added (1:5) before measurement. *Ignition loss* was determined as for the sediments. *Exchangeable  $\text{H}^+$*  was determined by soaking the soil in ammonium acetate at pH 7 allowed to stand overnight, filtered and titrated. «Exchangeable  $\text{H}^+$ » thus means the sum of  $\text{H}^+$  ions in the interstitial water and the  $\text{H}^+$  ions exchangeable by ammonium acetate.

*Ice and snow analyses.* The ice cores were sliced by a saw, cleaned with distilled water and melted in closed beakers. The snow was melted in closed plastic bags. The melted ice and snow were analysed with the same methods as for the water samples previously mentioned.

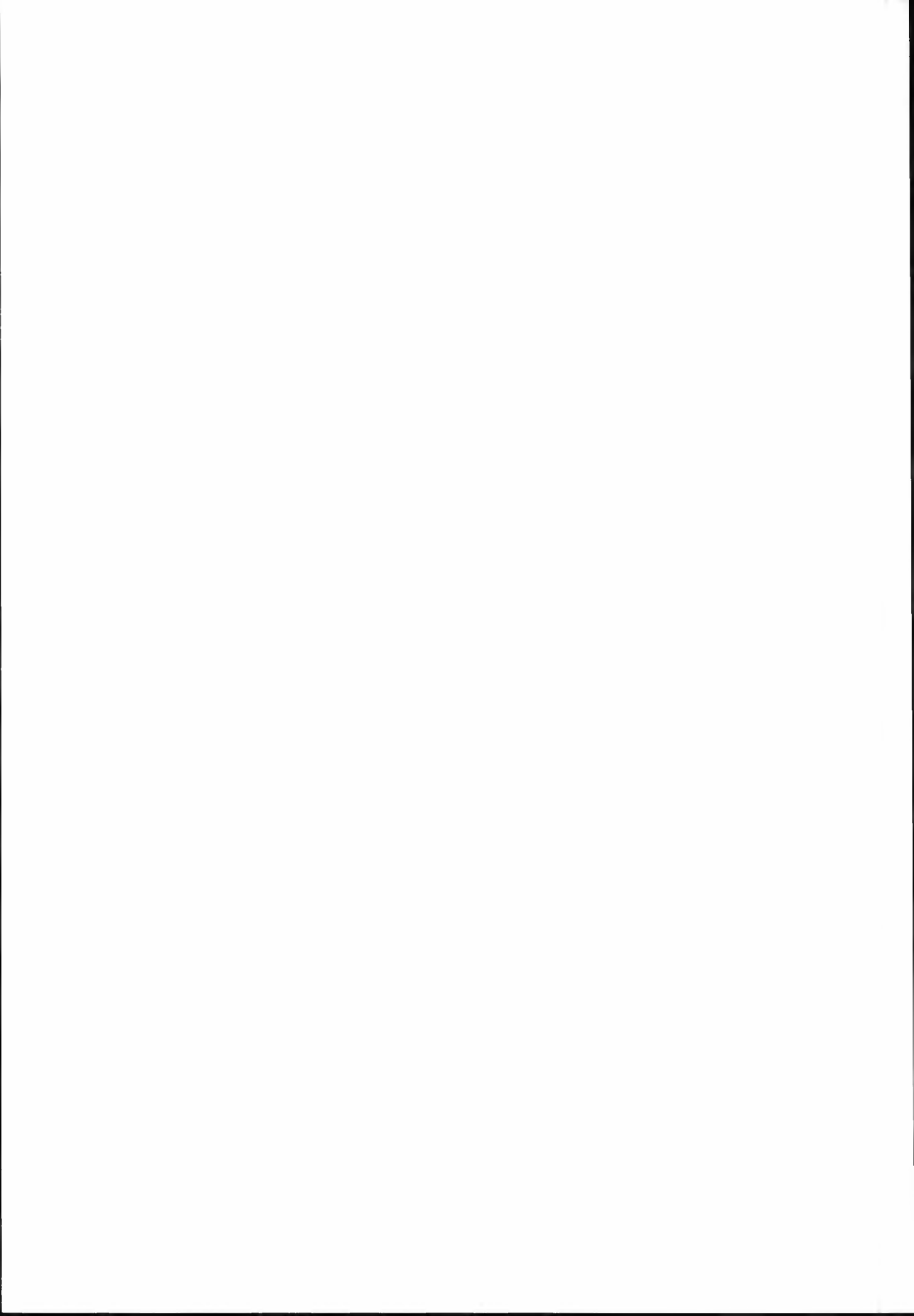

### III. DESCRIPTION OF THE AREA AND THE LAKES STUDIED

#### 1. Situation

The research area is in the northern part of Finnemarka, roughly speaking 60 km west of Oslo. 15 lakes situated about 500-600 m above sea level were chosen for intensive studies. Fig. 7 shows the position of the lakes. Some reference lakes (named Holleia), lying in an area not acidified to the west of Lake Tyrifjorden, are marked «R» to indicate the location which is further north outside the map.

#### 2. Morphology

The terrain is characterized by rocks resistant to weathering. The lakes are a result of selective glacier activity with minor amounts of loose deposits.

#### 3. Geology

Fig. 8 shows a map of the bedrock. All the intensively investigated lakes with exception of Lake Abbottjern (13) are lying in the Oslo region's intrusive Permian rocks, more exactly, in an area of biotite granite and kjelsåsite-larvikite (Holtedahl 1960) with very shallow overburden. This is a so-called sensitive area, with poor neutralizing capacity of the lakes and their catchments due to rocks poor in lime and resistant to weathering.

Lake 13 with its catchment lies partly in this area and partly in an area of marine Cambrian and Ordovician rock. The latter area is rich in lime and seems to prevent acidification of the lake. The reference area consists of Precambrian gneiss which contains some lime and is moderately resistant to weathering. Accordingly, the lakes seem to have avoided acidification so far.

#### 4. Soil

Alsaker-Nøstdahl (1976) has investigated the soil in Finnemarka and the author has made some sporadic observations and measurements in the research area. Jenny (1941) has described the general soil property (S) by the equation

$$S = f(\text{cl}, \text{o}, \text{r}, \text{p}, \text{t}, \dots)$$

where the variables are cl = climate, o = organisms, r = topography, p = parent material and t = time, and the three dots indicate additional, unspecified factors, for example fires, windstorms and cultural activities. These soil-forming factors have produced various soil types in Finnemarka. Alsaker-Nøstdahl (1976) has identified 5 main types in Finnemarka and these are also represented in the area investigated. These main soil types are: podzol soil, brown soil, transition podzol-brown soil, swampy soil >30 cm depth and swampy soil <30 cm depth. Podzol soil is further divided into 5 profile types: humus podzol, ferric podzol, humus ferric podzol, bleached soil to the bottom and raw-humus on bedrock. In the acidified area of Finnemarka podzol soil and swampy soil <30 cm depth seem to dominate. Since the soil formation is most pronounced in the upper stratum the soil property equation is elucidated by some chemical measurements of the humic layer.

*Chemical properties in relation to climate.* The content of organic matter in the soil, recorded as ignition loss, increases with increasing altitude in Finnemarka (Alsaker-Nøstdahl 1976). This is in accordance with Jenny (1941, 1961) who states that the organic content of soils generally increases with increasing humidity and decreases with

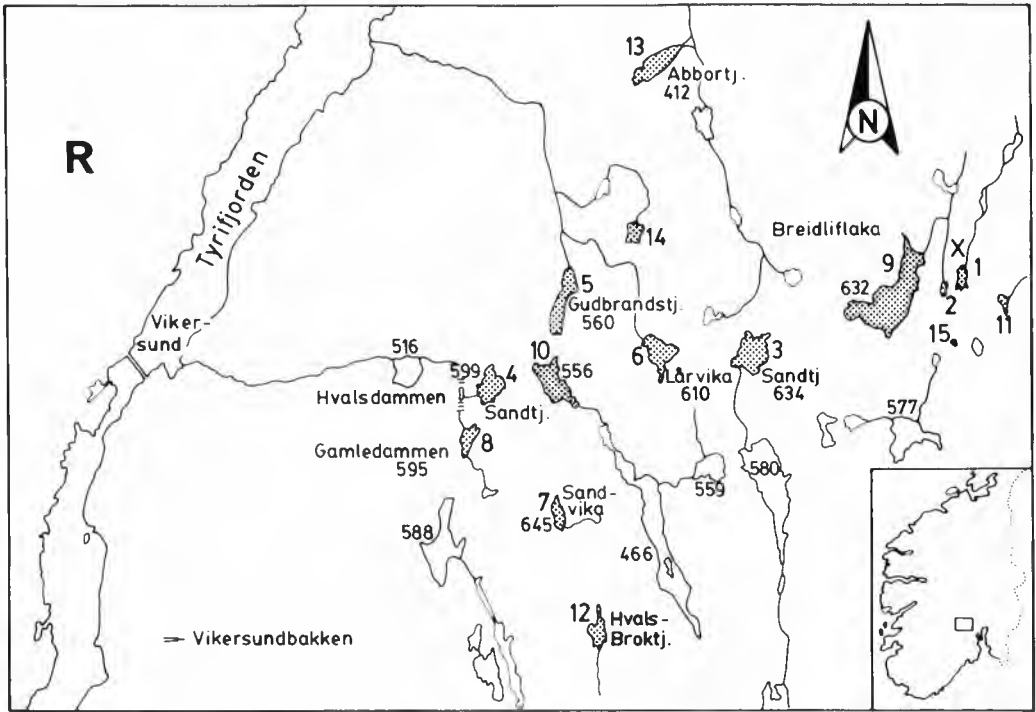

Fig. 7. Position of the lakes (Nos. 1-15). The field laboratory is marked «X». The reference lakes are lying outside the map north in the area marked «R».

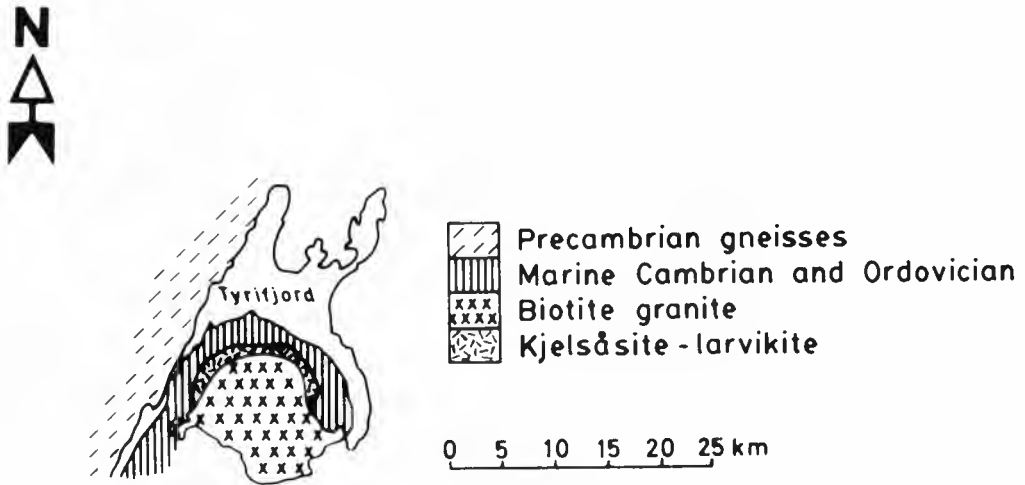

Fig. 8. Geological map of the research area.



increasing temperature. Alsaker-Nøstdahl (1976) also shows an increasing amount of exchangeable  $H^+$  ions in the humic layer with increasing altitude. This is due to a greater leaching of base cations and ion exchange caused by a higher amount of precipitation at higher altitudes. The cation exchange is against  $H^+$  ions. The altitude differences in the research area are relatively small and the above facts have therefore not been significantly recorded by the author.

*Chemical properties in relation to topography.* The mineral content (measured as ash) of the humic layer has been recorded in this research to be higher in terrain with steep rise than in flatter ground (10 samples have given values from about 40 to 60 %). This is also in accordance with the investigation by Alsaker- Nøstdahl (1976). The mineral content may be considered in relation to production and decomposition of organic matter (humus) in the soil. The most important factors with respect to balance between production and decomposition are supposed to be light, temperature, moisture and oxygen. These factors vary from flat to steeply rising ground and consequently also make differences in the balance mentioned.

Some measurements by the author indicate that the amount of exchangeable  $H^+$  ions is less in steeply rising terrain than in flat (10 values from about 40 to 70 meq/100 g). This may be seen in connection to percolating water moving nearly parallel to the ground surface. At the top of the slope the acid water exchanges  $H^+$  ions with other cations; in the middle of the slope the  $H^+$  exchanging process is assumed to be rather moderate. The difference in exchangeable  $H^+$  ions may also be regarded in relation to the different amount of organic matter (humus). It is reasonable to expect higher amounts of exchangeable  $H^+$  ions with higher amounts of organic matter.

*Chemical properties in relation to the parent material.* The ash content of the humic layer measured in this investigation reflects, as expected, an increase from the weathering-resistant intrusive Permian rocks to the more weathering-susceptible marine Cambrian-Ordovician rocks (10 samples from about 35 to 60 %). With regard to the amount of exchangeable  $H^+$  ions determined by the author, there seems to be a tendency towards smaller amounts from intrusive to marine rocks (10 samples from about 35 to 70 meq/100 g).

*Chemical properties in relation to vegetation.* It is reasonable to assume a connection between the vegetation and the chemical properties of the humic layer since its organic matter originates from the vegetation (litter). The ash content of the soil recorded in this research increases from pine through spruce to deciduous trees (5 samples from about 35 to 65 %). A similar trait seems to apply to the transition from heather to grass vegetation (5 samples from about 25 to 70 %). Alsaker-Nøstdahl (1976) describes the same picture. The explanation for this finding is simple. Needles from pine and spruce are more resistant to decomposition than grass and leaves from deciduous trees.

The  $H^+$  content (measured as pH) recorded by the author decreases from heather to grass vegetation and also from pine and spruce to deciduous trees (10 pH values from about 3.5 to 5.5). This is in accordance with Bergseth (1977).

## 5. Vegetation

The main research area consists of heather vegetation with spruce, pine and some birch. Lichens and mosses are also seen, especially on rocks and in bogs. The trees are growing slowly due to the barren soil and rock (granite). The catchment of Lake Ab-

bortjern (13) is mainly covered with more rapidly growing spruce due to more fertile soil and rock (marine Cambrian-Ordovician) and somewhat better climate (100-200 m lower altitude).

Grass vegetation is observed near abandoned outfield farms and represents old meadows which today are invaded by heather, mosses and trees.

## 6. Activities

Compared to 30-50 years ago there is relatively little activity at present in the research area. The most obvious changes are connected to the cessation of outfield farming and associated activities (Røgeberg 1982). These changes have resulted in smaller amounts of manure and reduced area of grassland in the lakes' catchments. The manure is assumed to have given higher productivity both on land and in water in earlier times and the grazing activity to have prevented invasion of heather vegetation and trees on grassland. The research area is still somewhat used for recreation, but today there is little cultivation of the water resources, e.g. cleansing of spawn brooks, because of the general extinction of fish populations in the area. Lake 9 is regulated about 4 m for supplying water to a small power station in the winter (see Grøterud 1984b).

## 7. Hypsography

This term is used for the lake and drainage area as distinct from the term bathygraphy, which is used for the lake only (Grøterud 1972 b). Hypsography seems to be a useful tool in describing the influence of the landscape on the lake. In other words, to what degree the lake is a world of its own and to what degree it is part of the landscape. The hypsography of the 15 lake areas is elucidated by the hypsographical maps (Fig. 9), the hypsographical curves (Fig. 10) and the morphometric values (Table 2). The hypsographical maps and curves have been drawn on the basis of maps constructed by A/S Viak in the scale 1:5000 and field observations and measurements. The boundaries of the catchments were determined by stereo-models of aerial photos and observations on rainy days. Of the morphometrical values, relative depth and the catchment's drainage potential and symmetry need further explanation. Relative depth ( $Z_r$ ) is the maximum depth in percentage to the average diameter of the lake surface. The formula used here is taken from Cole (1975).

$$Z_r = 100 \frac{Z_m}{d} = \frac{88,6 Z_m}{\sqrt{A_0}}, \text{ where } d = \sqrt{\frac{4A_0}{\pi}}$$

The catchment's drainage potential (CDp) is defined as the ratio of the area under the hypsographical curve above lake level to the area under the bathygraphical curve (Grøterud 1972b). The catchment's symmetry ( $C_s$ ) is defined as follows (Grøterud 1972b):

$$C_s = \frac{A_c}{\pi R_c^2}$$

$A_c$  is the catchment area including area of the lake ( $A_0 + A_d$ ) and  $R_c$  is the distance from centre of the lake surface to the most distant point in the catchment area.

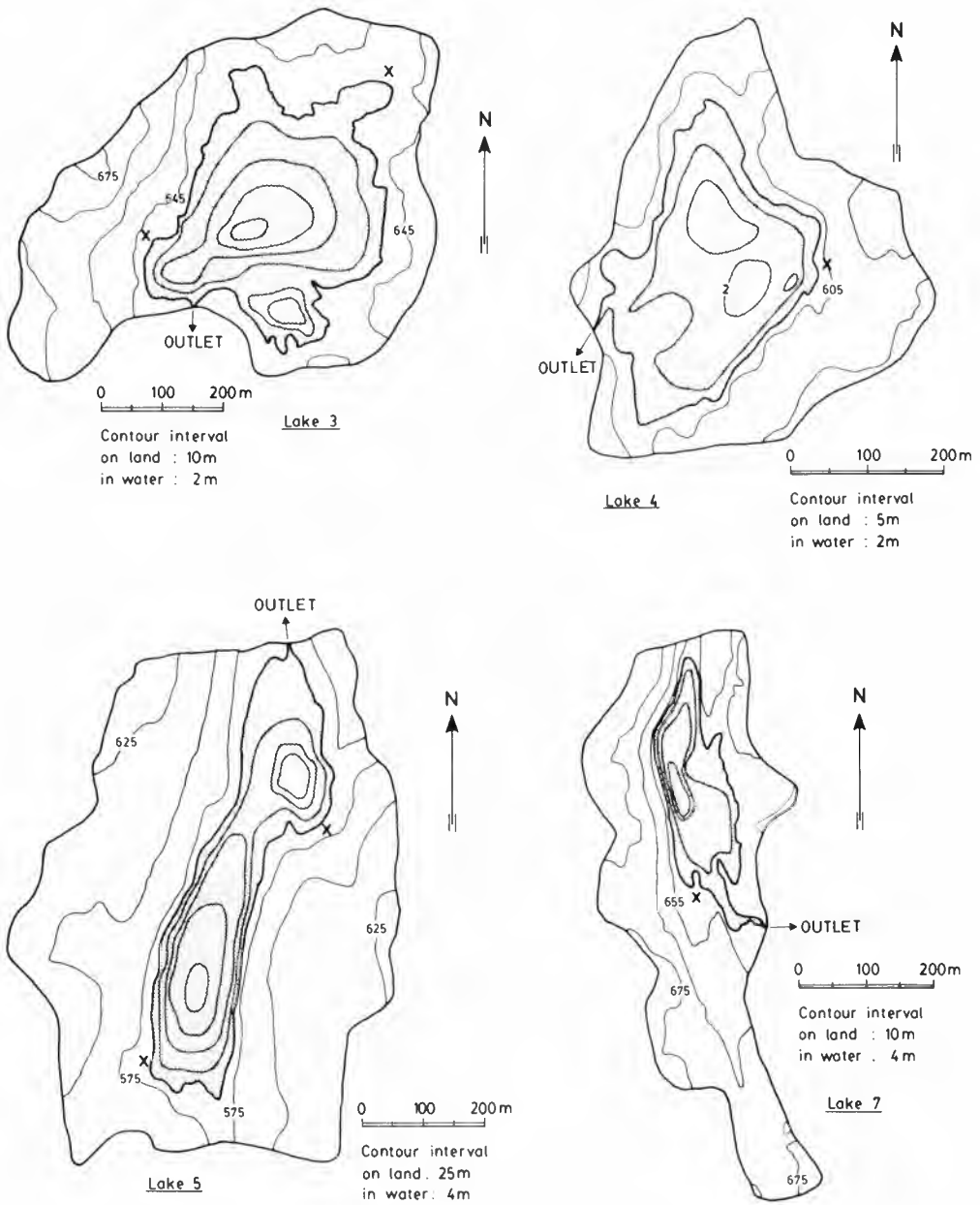
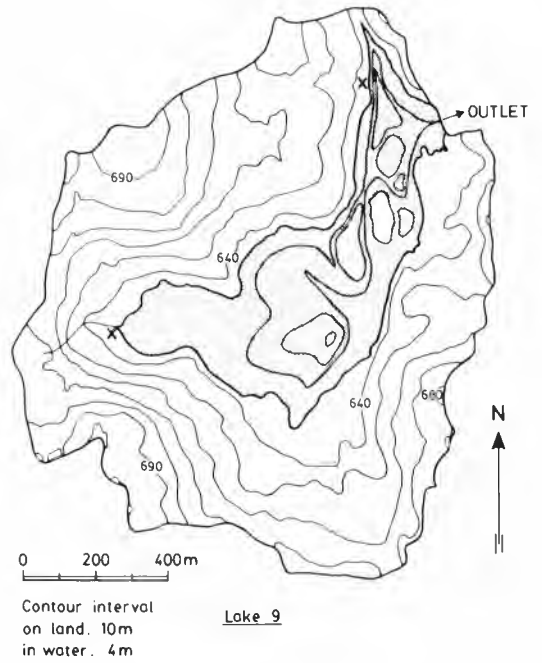
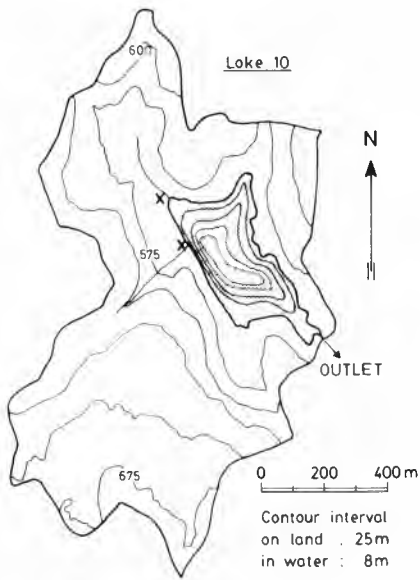
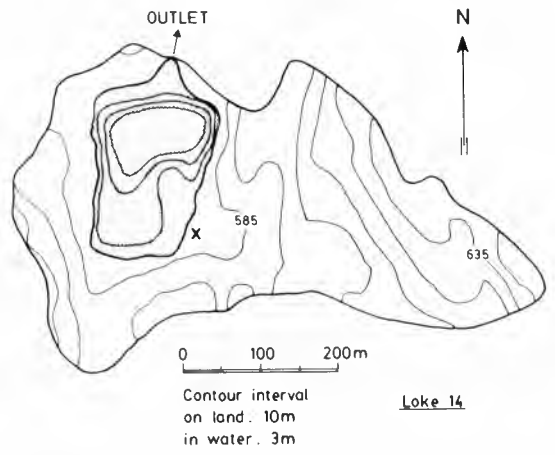
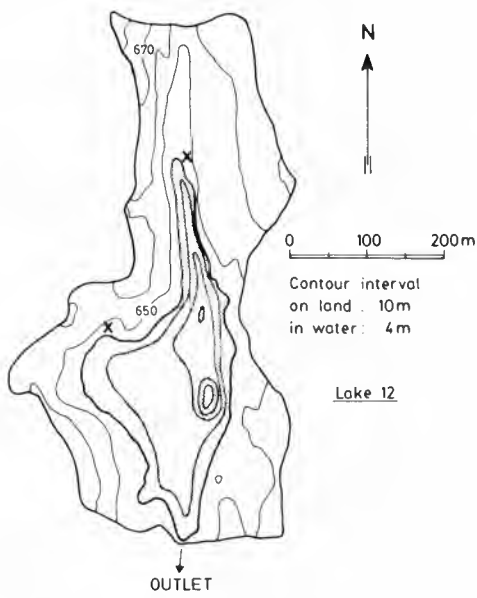
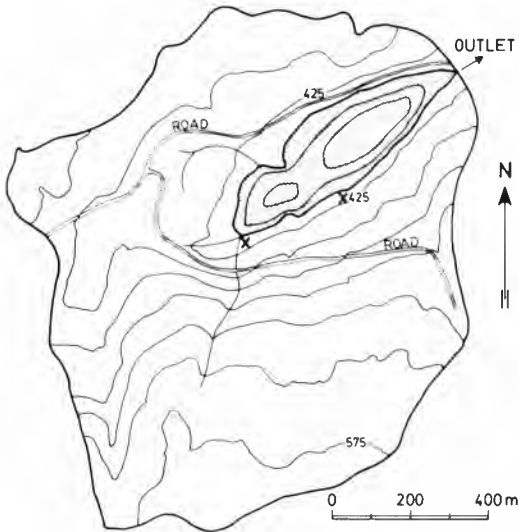

Fig. 9. Hypsographical maps of the lakes. The locations of the main drainage measurements are marked by crosses.





Lake 13

Contour interval  
on land : 25m  
in water : 6m

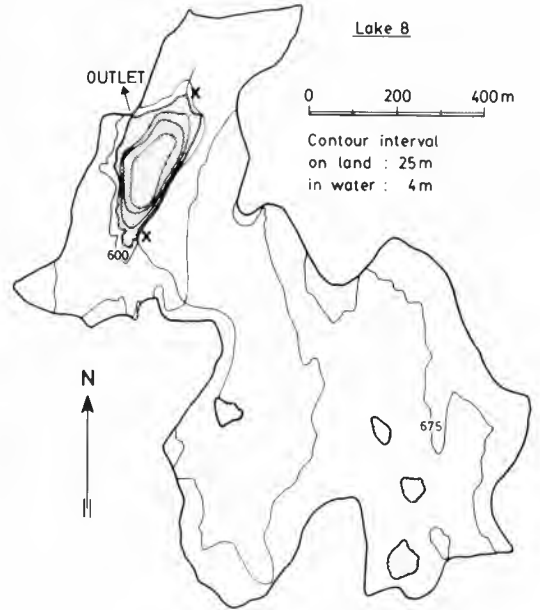

Lake 8

0 200 400m

Contour interval  
on land : 25m  
in water : 4m

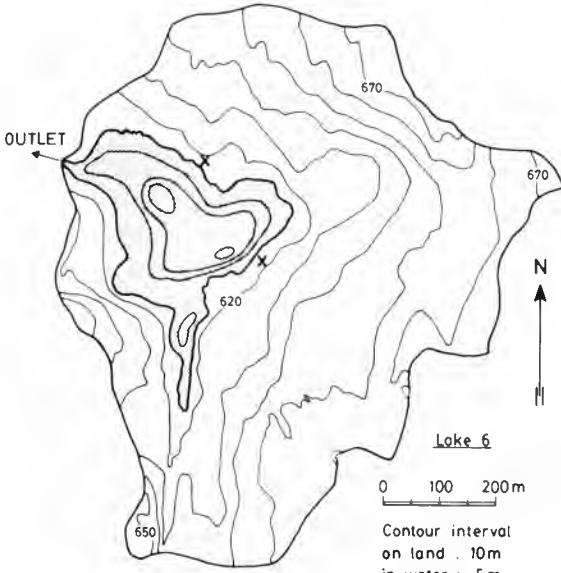

Lake 6

0 100 200m

Contour interval  
on land : 10m  
in water : 5m

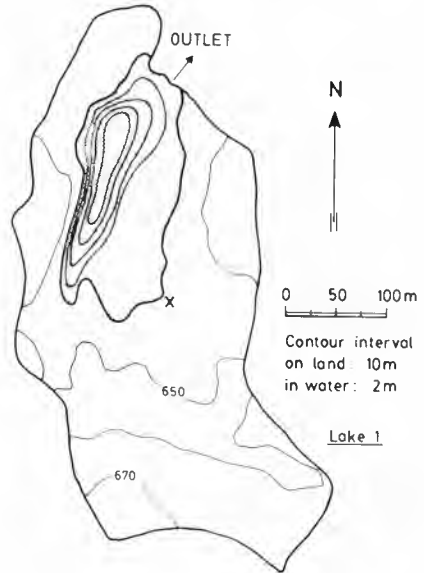

Lake 1

0 50 100m

Contour interval  
on land : 10m  
in water : 2m

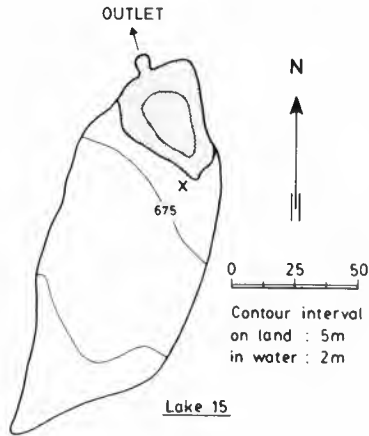
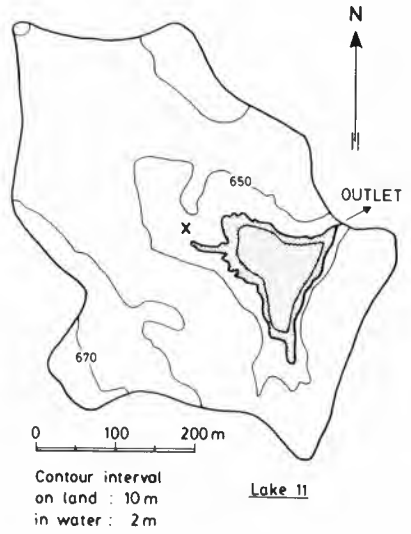
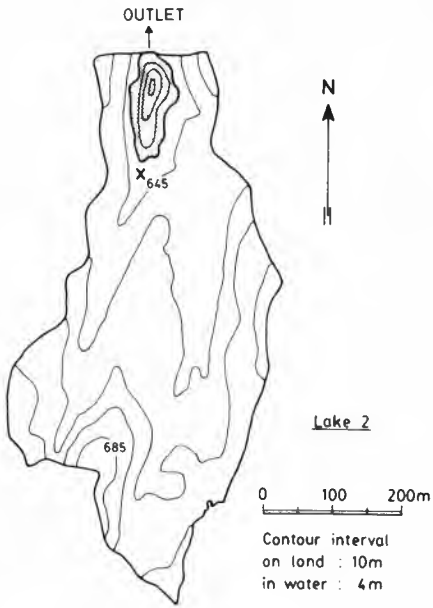

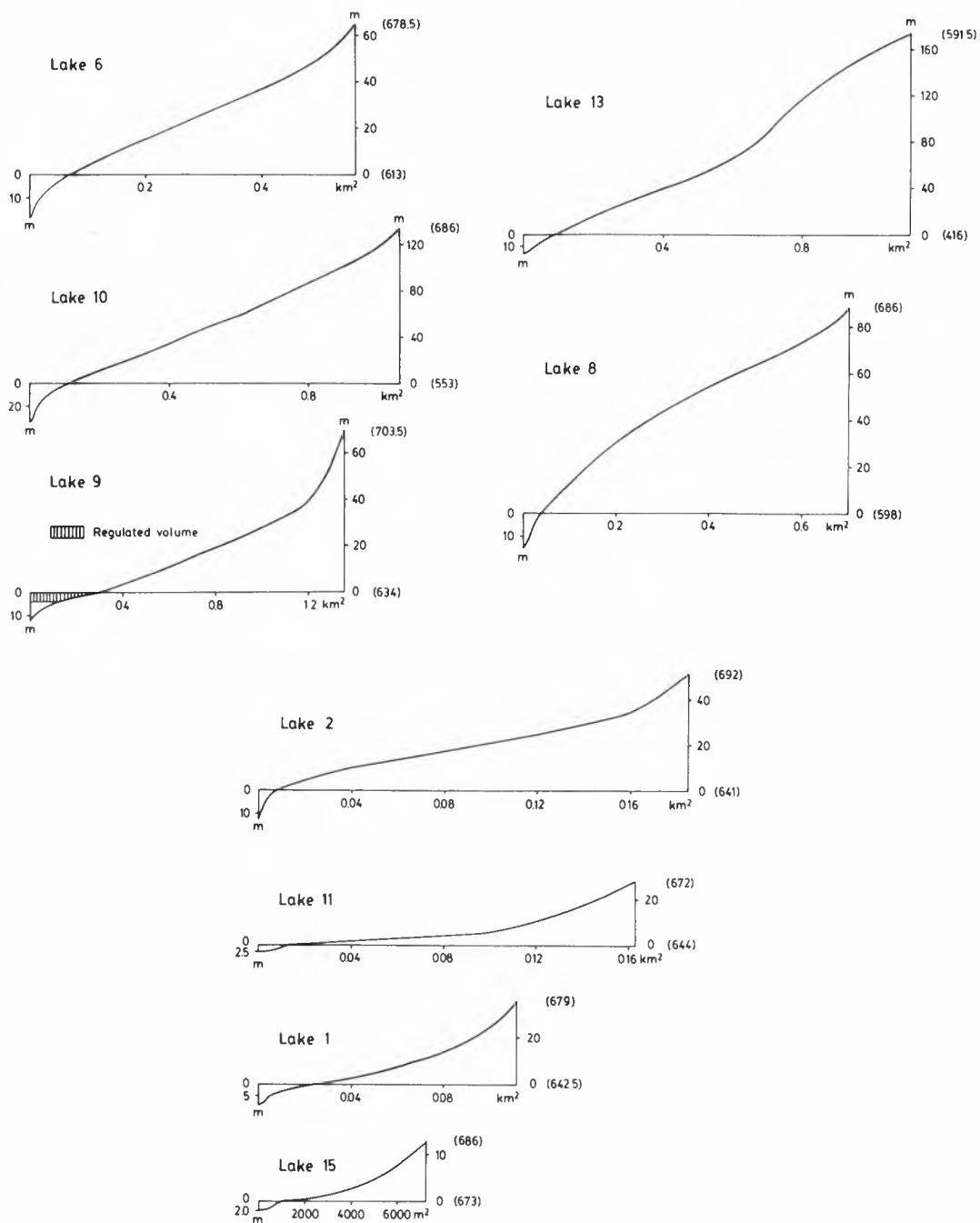

Fig. 10. Hypsographical curves of the lakes.

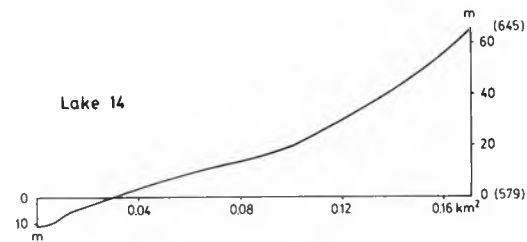
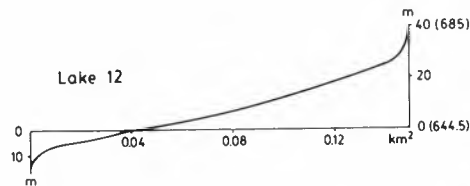
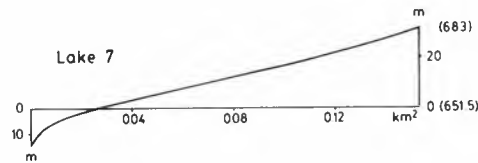
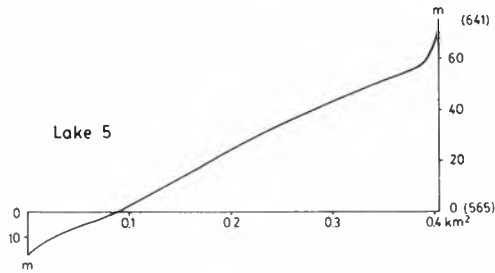
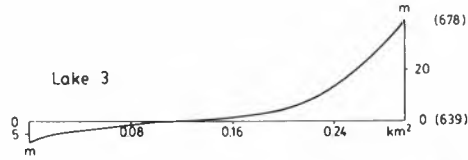
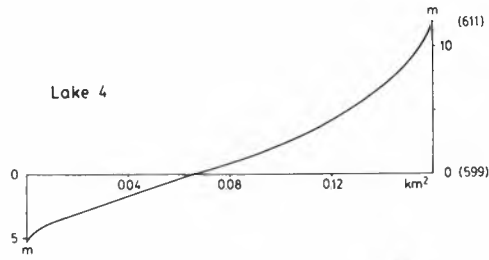



Table 2. Morphometric values of the investigated lakes

Name	No.	Altitude		Lakesurface		Maximum depth ( $Z_m$ ) m	Lake volume (V) $m^3$	Mean depth (Z) m	Catchment area ex- cluded ( $A_d$ ) $m^2$	Land/water area ratio ( $A_d/A_0$ )	Relative depth ( $Z_r$ ) = $88.6 Z_m / \sqrt{A_0}$ %	Land area/water volume ratio ( $A_d/V$ ) $m^{-1}$	Catchment's drainage potential (CDp)	Catchment's symmetry ( $C_s$ )
		above sea level, m	area ( $A_0$ ) $m^2$	area ( $A_0$ ) $m^2$	depth (Z) m									
Store utg.tj.	1	642	22500	9.0	79000	3.5	89375	4.0	5.3	1.1	13	0.2		
Lille utg.tj.	2	641	7750	13.0	37000	4.8	177500	22.9	13.1	4.8	102	0.1		
Sandtj.	3	639	110250	8.5	340000	3.1	180000	1.6	2.3	0.5	6	0.4		
Sandtj.	4	603	65000	5.2	140000	2.2	92000	1.4	1.8	0.7	3	0.5		
Gudbrandstj.	5	565	88125	18.0	630000	7.2	322940	3.7	5.4	0.5	16	0.5		
Lårvika	6	613	75500	18.0	432000	5.7	560000	7.4	5.8	1.3	32	0.4		
Sandvika	7	651	27375	14.5	235000	8.6	125625	4.6	7.8	0.5	8	0.1		
Garnledammen	8	598	36125	17.0	280000	7.8	662625	18.3	7.9	2.4	98	0.2		
Breilivann	9	634	314000	13.0	1080000	3.4	1039000	3.3	2.1	1.0	19	0.5		
Svartj.	10	553	106876	34.0	1500000	14.0	952375	8.9	9.2	0.6	36	0.3		
Andtj.	11	644	12500	2.5	20000	1.6	150750	12.1	2.0	7.5	58	0.3		
Hvals-Broktj.	12	644	40625	16.5	210000	5.2	108875	2.7	7.3	0.5	5	0.2		
Abborrtj.	13	416	90000	16.5	775000	8.6	1024000	11.4	4.9	1.3	103	0.3		
Ventj.	14	579	30750	10.5	160000	5.2	139750	4.6	5.3	0.9	22	0.2		
Pytt	15	673	1075	2.0	1500	1.4	6175	5.7	5.4	4.1	17	0.1		

$C_s$  is defined to be an indication of the water's average drainage distance to the lake, e.g. a high value indicates a relatively short average drainage path to the lake.  $CD_p$  is meant to be an indication of the quantity and potential energy of the drainage water in relation to the lake volume, e.g. a high value indicates a rapid drainage influence on the lake, especially if the catchment's symmetry is also high.

In conclusion, the hypsographical importance of a lake's hydrology and water quality may be considered by parameter values (morphometric values) and parameter figures (hypsographical maps and curves). The 15 investigated lakes show great variation regarding the morphometric values (Table 2). Altitude above sea level varies from 414 m (Lake 13) to 673 m (Lake 15), lake surface area from 1075 m<sup>2</sup> (Lake 15) to 314000 m<sup>2</sup> (Lake 9), maximum depth from 2.0 m (Lake 15) to 34.0 m (Lake 10), lake volume from 1500 m<sup>3</sup> (Lake 15) to 1500000 m<sup>3</sup> (Lake 10), mean depth from 1.4 m (Lake 15) to 14.0 m (Lake 10), catchment area excluding lake from 6175 m<sup>2</sup> (Lake 15) to 1039000 m<sup>2</sup> (Lake 9), land/water area ratio from 1.4 (Lake 4) to 22.9 (Lake 2), relative depth from 1.8 % (Lake 4) to 13.1 % (Lake 2), land area/water volume ratio from 0.5 m<sup>-1</sup> (Lakes 3, 5, 7, 12) to 7.5 m<sup>-1</sup> (Lake 11), catchment's drainage potential from 3 (Lake 4) to 103 (Lake 13) and catchment's symmetry from 0.1 (Lakes 2, 7, 15) to 0.5 (Lakes 4, 5, 9).

The hypsographical maps and curves of the 15 lakes may visualize the great variation in hypsography already shown by the morphometric values. Of special interest is the shape of the hypsographical curves near the lakes, that is whether they are concave or convex. A convex curve may indicate an increased transport effect by the runoff into the lake and a concave curve the opposite, namely a decreased transport effect. Examples of convex curves are Lakes 8, 5 and 6 and of concave curves Lakes 3, 15 and 11.

## 8. Climate

Finnemarka has a climate which may be characterized as continental with moderate amounts of precipitation, relatively low winter and high summer air temperatures and not especially strong winds. Only a few air temperature registrations have been carried out in the research area. The Norwegian Meteorological Institute however, has two stations in the same climatic area, Fossum in Modum (2616) and Tryvasshøgda II (1896), which have been used in the project. Following the recommendations from the Norwegian Meteorological Institute, the precipitation registrations were taken from the station Fossum in Modum (described in connection with the chapter on hydrology) and the air temperature measurements from the station Tryvasshøgda II. The latter station lies 514 m above sea level, about 60 km east of the investigated lakes.

The monthly mean air temperatures for the period 1931-60 (reference values) and the monthly air temperatures for the years 1970-82 (research period) are given in Fig. 11. There were no great deviations from the reference values during the research period, but some winter temperatures were somewhat lower (1970, 1978, 1980) or higher (1973, 1974, 1975) and the same is seen for the summer temperatures (higher 1975, 1976 and lower 1974, 1978, 1979). The annual mean air temperature for the period 1931-60 is 3.70°C and the annual air temperatures for the years 1970-82 are; 2.44 (1970), 3.83, 3.53, 3.89, 4.38, 4.90, 3.68, 3.28, 2.73, 2.20, 3.20, 2.84 and 3.82°C (1982). Cold years occurred in 1970, 1978, 1979 and 1981 and warm years in 1974 and 1875. The annual mean air temperature for the research period is 3.44°C, i.e. somewhat lower than for the reference period. Precipitation is treated in the chapter on hydrology, but some data of importance for describing the climate are given below. The annual mean precipitation for the period 1931-60 is 685 mm and the annual values for

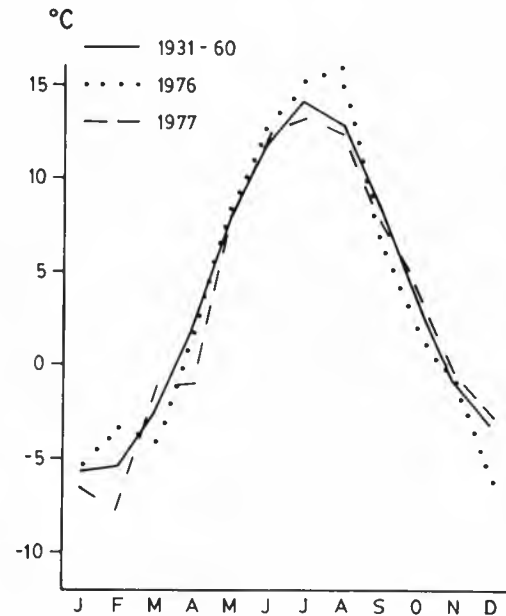
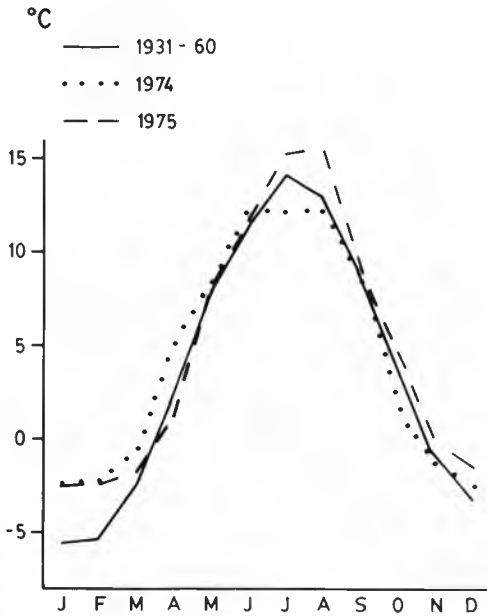
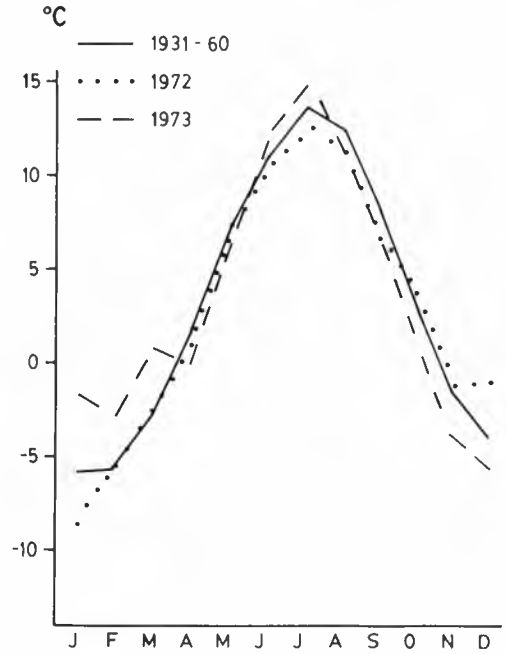
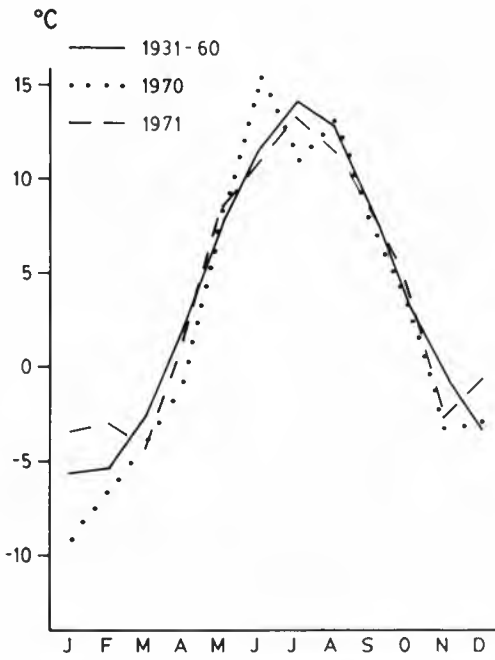
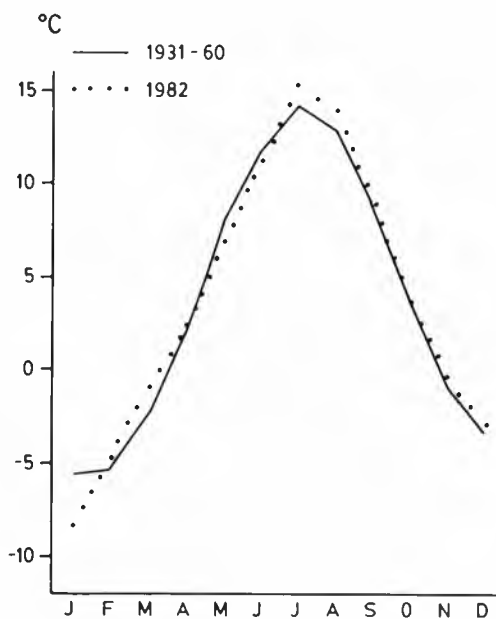
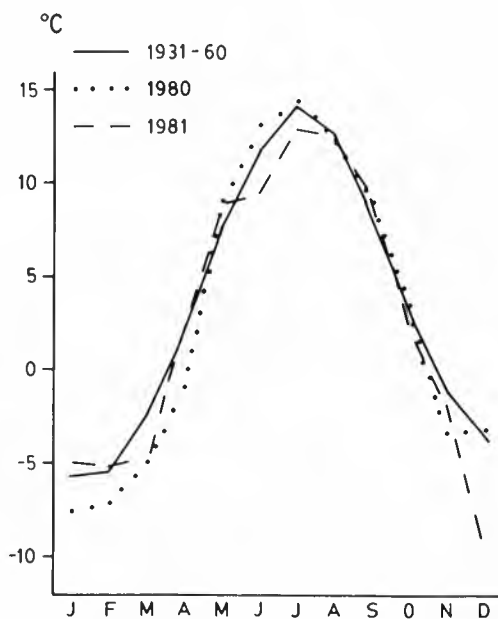
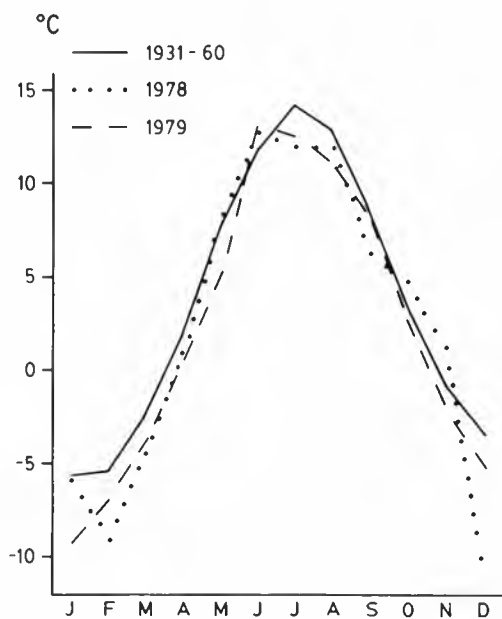

Fig. 11. Monthly mean air temperatures in the normal (1931-60) and research (1970-82) periods.



the research period are: 787 (1970), 585, 618, 600, 698, 496, 552, 785, 630, 753, 582, 574, 778 mm (1982). Wet years occurred in 1970, 1977, 1979 and 1982 and, of these, 1970 and 1979 were also cold years. Dry years occurred in 1975 and 1976 and the former was also warm. The annual mean precipitation for the research period is 649 mm, hence somewhat less than for the reference period. With regard to the yearly distribution of precipitation during the research period, there seems to be a tendency of higher autumn values than in the period 1931-60 (see Fig. 21).

Systematic wind observations were not carried out in the area, but general experience during the research period indicates relatively moderate winds. Wind effects on the lakes seem to vary due to the differences in hypsography. By studying the hypsographical maps and curves, it is reasonable to expect stronger winds on Lakes 3, 4, 9, 11 and 12 than on the other lakes. This is also in accordance with experience.

### **9. Chemistry of precipitation, snow and ice profiles**

The rain and snow samples were routinely analysed for the major ions plus total phosphorus. In addition, more sporadic analyses of aluminium, iron, manganese, reactive silicate and orthophosphate were carried out. The mean values for the routine analyses during the twelve years 1970-1982 and the three hydrologic years 1977/78-1979/80 are presented in Table 3. The data obtained are in agreement with Overrein et al. (1980). The mean values in a given period (1977/78-1979/80) were separated for use in a budget calculation of different components in the lakes. This period has roughly speaking the same mean values as the twelve-year period. Only the difference in the mean concentration of  $\text{NH}_4$  is worth mentioning.

The sporadic analyses of iron, manganese, aluminium and reactive silicate gave generally small values (often below the detection limits). But in a few cases the values could be relatively high, often connected to high concentrations of impurities (e.g. high concentrations of  $\text{SO}_4$  and  $\text{NO}_3$  and low pH). Precipitation analyses from the area have previously been discussed (Grøterud 1972b). All analyses of the precipitation indicate a levelling-off of the air pollution in Finnemarka during 1970-82.

Snow profile analyses are of interest for at least three reasons: 1. to get information retrospectiv about the precipitation quality already fallen, 2. to get information about the development of the snow layers with respect to the concentration changes of important chemical components during the winter, and 3. to get information about the amounts of components stored in the snow cover just before the spring snowmelt.

Many chemical analyses of snow profiles have been done in the catchments of the investigated lakes. The values obtained are not presented owing to lack of space, but some concluding remarks will be given. Generally the concentration of electrolytes decreases from the top to the bottom of the snow layers. This was most marked at the end of the winter. This phenomenon is supposed to be caused by melting processes in the oldest snow, where the melt water is more concentrated in electrolytes than the bulk snow. Such fractionation is well documented (Johannessen & Henriksen 1978, Johannessen et al. 1980) and is qualitatively understandable when considering how the impurities are stored in the snow (Overrein et al. 1980). The impurities are located both in the crystals and on their surfaces in freshly fallen snow.

With time the snow particles change in shape, strength and volume weight owing to transfer of water molecules through the liquid and vapour phase and other processes.

Table 3. Results from the precipitation analyses, expressed as volume - weighted mean values, during the twelve years 1970/82 and the three hydrologic years 1977/78 - 79/80. All ions are given in  $\mu\text{eq/l}$  and total P in  $\mu\text{g/l}$

Period	H <sup>+</sup>	Ca	Mg	Na	K	NH <sub>4</sub>	$\Sigma$ cations	SO <sub>4</sub>	NO <sub>3</sub>	Cl	$\Sigma$ anions	Total-P
1970-82	42	5	5	10	7	33	102	61	32	11	104	33
1977/78-79/80	40	5	5	9	7	29	95	63	30	10	103	35

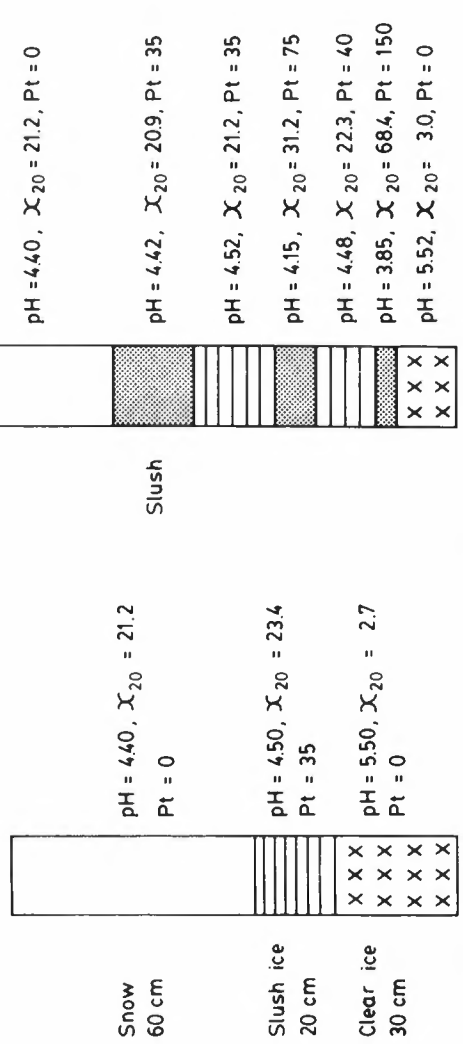

Fig. 14. Two examples of snow-ice profiles on the lakes with characteristic physical and chemical properties.

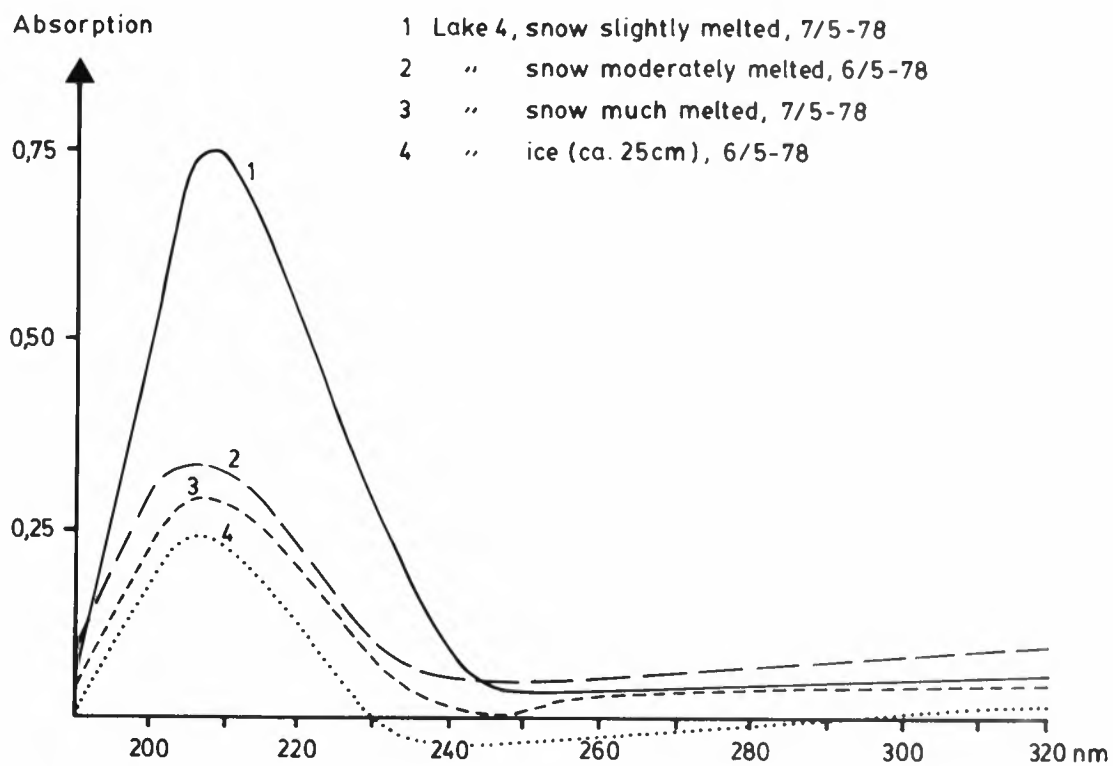

Fig. 12. Ultraviolet light absorption characteristics for snow-sheets of varying degree of melting and lake ice.

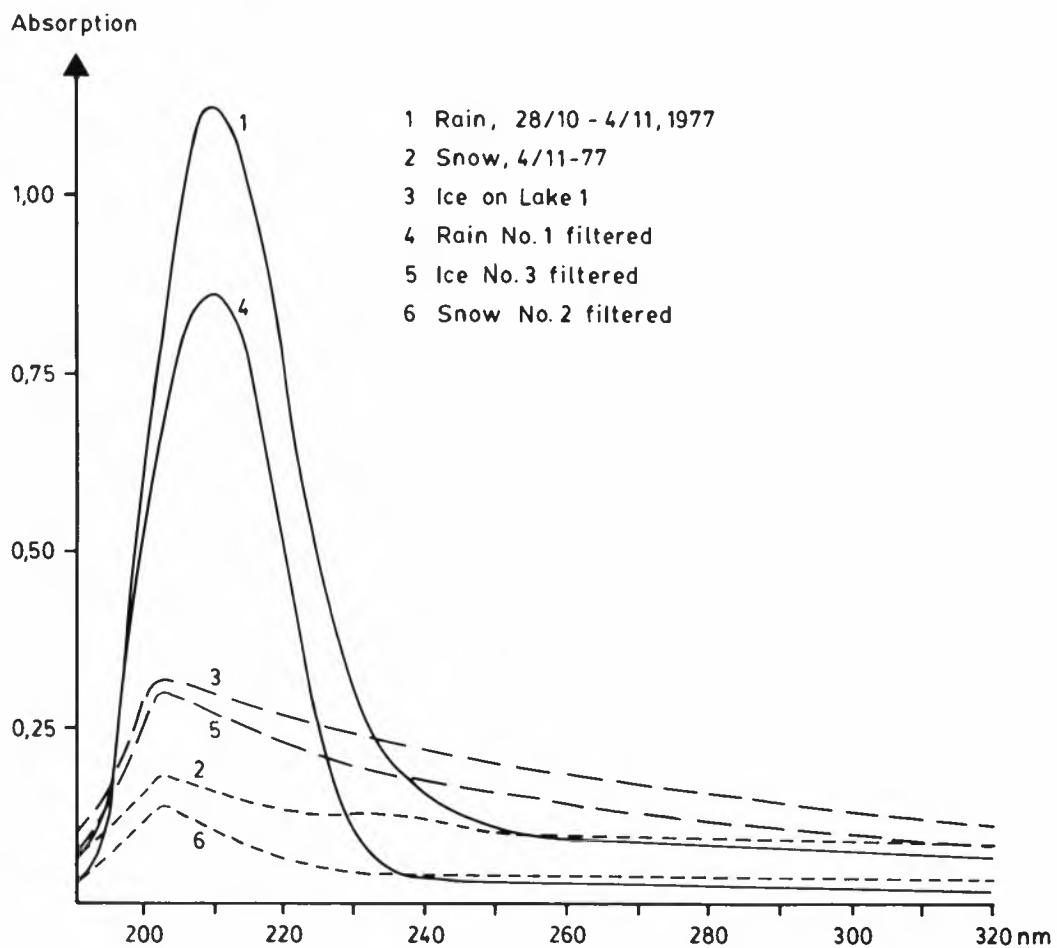

Fig. 13. Ultraviolet light absorption characteristics for newfallen rain and snow and lake ice, both filtered and unfiltered samples.



These transformations are fast at temperatures around zero. Most impurities are found in brines at the crystal surfaces, first of all at the boundaries of the snow grains. This applies also to snow at the beginning of the melting period, although it is more pronounced at a later phase (Seip 1980). A freezing point depression in the brines will bring about a network of veins in the snow cover where the soluble impurities may be drained out (Renaud 1949, Overrein et al. 1980).

As a consequence of this fractionating snowmelt the content of acids (measured as pH) decreases in the profile as described for the electrolytes. Some exceptions from this general picture were, however, recorded. Grey coloured snow layers, located in all depths during the research period, revealed relatively high concentrations of electrolytes (pollutants). These layers have probably been formed in precipitation periods with so much air pollution that the later fractionation effect is not clearly obvious.

The snowmelting, and hence the development of the chemical stratification in the snowpack, has shown relatively great variation owing to varying exposure to sunshine in the catchments. Many snow analyses at the end of the winter have revealed relatively great concentrations of chemical components (low pH, high conductivity) in snowpacks lying in the shade, either topographically (north-east position) or because of dense forest. On the other hand, snow lying well exposed to sunshine have given very small values. These findings indicate that the snowmelt fractionation is not synchronous in the catchments and that the effect on the runoff will be small, with the exception of the very first snowmelt period.

The quality of newfallen and old snow has also been investigated by ultraviolet light absorption measurements (Grøterud in prep.). Figs. 12 and 13 gives some examples of such measurements, and the most striking features are the generally higher absorption values for newfallen snow (slightly melted snow) compared with old snow (very melted snow), and that this difference is most pronounced around 210 nm. The difference in nitrate leaching is supposed to be the main reason for these findings at 210 nm. At this wavelength nitrate has the maximum absorption (Brown & Bellinger 1978).

The snow falling directly on the surface of the lake ice is of special importance for the lake water quality in the spring thaw (Grøterud 1978, Adams et al. 1979). When recording the amount of components stored on the lake surfaces just before the ice break-up, it is necessary to take into consideration analyses of the whole snow-ice cover. The lake ice and the snow interact to form the final physical and chemical structure of the snow-ice cover by snowmelt (fractionation) and seeping through pores in the snowpack and by outfreezing of components to the lake water with upwelling through cracks in the ice cover. The snow-ice covers will as a consequence occur in many types of physical and chemical structures at the end of the winter. Two snow-ice profiles chosen from measurements in the research area are given in Fig. 14. The profiles could be regarded as typical examples of simple and complex stratification found on the investigated lakes during the research period. The simple profile with only snow, slush ice and clear ice is observed in years with low temperatures and small amounts of snow, especially in the beginning of the winter. In these years the clear ice (very strong) could grow to a relatively thick layer (30-50 cm), preventing great quantities of upwelling water on the ice surface. The regulated lake (Lake 9) seems generally to develop an ice-cover with smaller amounts of upwelling water than the other lakes. This is probably due to

the artificial discharge of water through the dam gate (at about 4 m depth) during the winter in connection with the runoff regulation (Grøterud 1984b).

### 10. Minicatchments and micro-drainage

The catchments of the lakes could roughly speaking be regarded as mosaics of many minicatchments (Grøterud 1987). A mini-catchment is illustrated in Fig. 15. The minicatchments can drain directly into the lake or via other minicatchments. The water flow in the catchments will primarily be determined by the flow dynamics in the minicatchments as shown in Figs. 15 and 16. These flow dynamics indicate that the main water volume is conducted through small depressions in the minicatchments before entering the lake or other minicatchments. This means that the precipitation will be influenced by bogs or podzol soil on moraine deposits, even if bare rocks dominate in the catchment. The percentage of bare rocks in the investigated catchments is, however, low. Heather vegetation on a thin layer of humus or soil characterized by shortened podzol profiles is typical of the minicatchments of the research area.

A vertical profile of two typical minicatchments, in this case connected to each other, is schematically outlined in Fig. 16. The highest minicatchment, with podzol soil on a moraine deposit in the depression, affects the runoff of the lower minicatchment. The water movements are primarily in the humic layers in the beginning of the flood periods (snowmelt on frozen ground or heavy rain) and later also in the mineral soils, i.e. at the end of the floods.

These flow dynamics are of decisive importance for understanding of the water quality in the runoff from the minicatchments. The humic layers contain great amounts of hydronium ions and water-soluble coloured organic matter (Rosenqvist 1977, Rueslåtten & Jørgensen 1978, Overrein et al. 1980), which act as an acid buffer on the precipitation infiltrating the area. The water is in this case acid ( $\text{pH} = 4.0 - 4.5$ ), with brown colour roughly independent of the inherent acidity, after having moved through the minicatchments. When the water also passes through the mineral soils the colour and acidity are generally lower, and the very small amount of water moving through the moraine deposits is weakly acid ( $\text{pH} = 6.0$ ) and weakly coloured. The latter phenomenon has been recorded in some boring holes of the moraine deposits in the minicatchments.

Micro-drainage is here defined as very small water flow or water seepage in the minicatchments (Grøterud 1987), as shown in Figs. 15 and 16. This drainage has been collected and analysed at many places and times, especially during the snowmelt period. A typical example of such measurements is given in Fig. 16. The striking feature is that the hydronium ion concentration is much higher in the micro-drainage than in the bulk snow. This may partly be due to the snowmelt fractionation already discussed and leaching of ions (including ion exchange) from the humic layers. There is reason to believe that leaching is the primary supplier of hydronium ions, since fractionation could be of significance only in the beginning of the snowmelt. Gorham et al. (1985) have discussed the free hydronium ions in bog waters (humic waters) with reference to organic acids, to sulfuric acid and to cation exchange between metal cations in precipitation and hydronium ions adsorbed to the polygalacturonic acids that make up the cell walls in *sphagnum* moss and peat. In addition to these hydronium contributions there is reasons to believe that nitric acid and metal cations, leached from the soils and rocks in the drainage area, also are of importance regarding the hydronium supply to the drainage water.

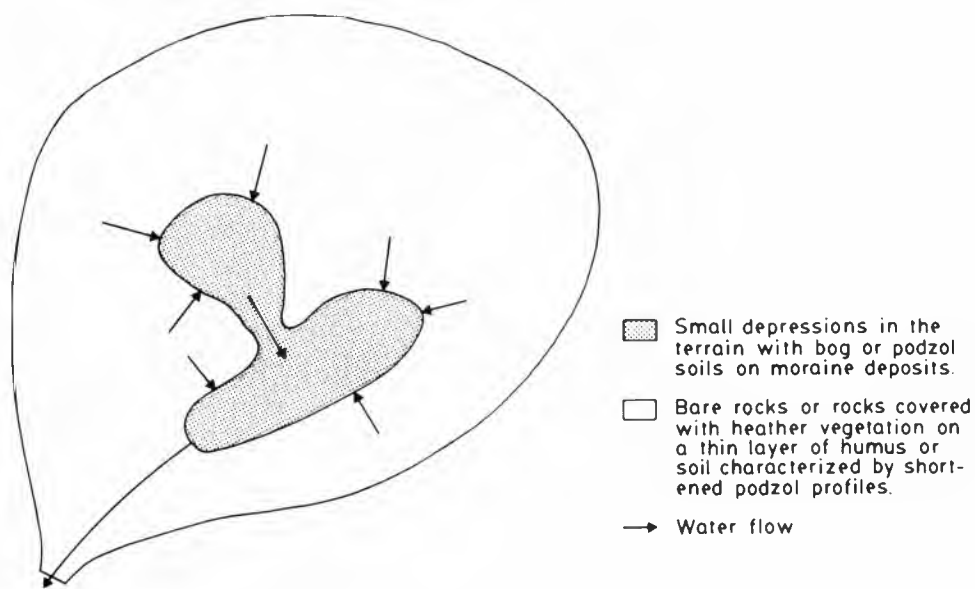

Fig. 15. Schematic outline of a minicatchment.

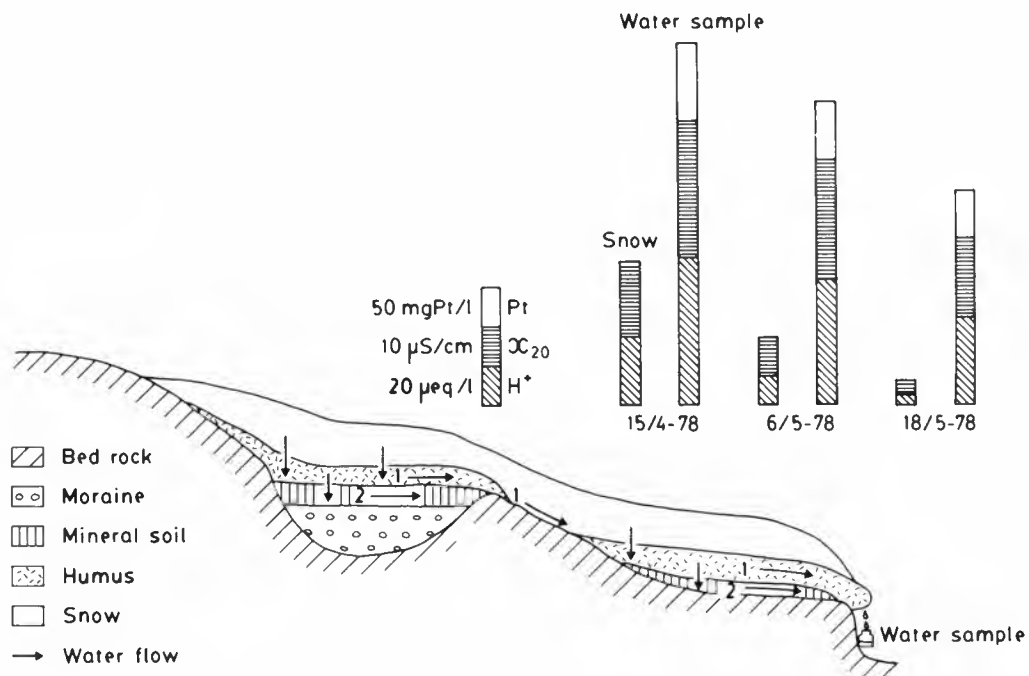

Fig. 16. Schematic outline of a vertical profile of the two minicatchments connected together with some runoff measurements during the meltwater period.

The decreased supply of hydronium ions from the humic layers at the end of the snow-melt is an expected dilution effect. In the late autumn and the winter before the snow-melt, hydronium ions have been accumulated and produced. This builds up a storage which the spring flood drains, more or less completely.

Runoff studies in some small catchments (made up of two or more minicatchments) of the lakes show, roughly estimated, a pH increase from 4.2 to 4.4 in the drainage water, while the pH increased from 4.0 to 5.0 in the snowmelt water (which was collected separately in plastic vessels). These data are in agreement with Seip et al. (1979) and indicate that the soil directly regulates about 75 % of the hydronium concentration in the drainage water. Rosenqvist (pers. comm.) has mentioned similar findings.

The ultraviolet absorption characteristics of different drainage waters are given in Figs. 17 and 18. Precipitation and lake water are also presented for comparison. The quality of the waters is roughly reflected by the ultraviolet absorption characteristics (Foster & Foster 1977, Sheppard 1977, Brown & Bellinger 1978, Grøterud in prep.). The snow (melted) has low absorption values at 240-320 nm (especially old snow) and a maximum at 200-210 nm. The drainage (from various minicatchments) has much higher absorption values at 240-320 nm and a maximum at 220-250 nm. The lake water has absorption values and maxima between those of the precipitation and the drainage. This is reasonable, as a mixture of these two water types is dominant in the lakes. For example, Lake 4 and Lake 8 in Fig. 18 are strongly and little influenced respectively by drainage water. The crack in the ice of Lake 4 has an absorption characteristic much like that of melted snow, as expected (the snowmelt fills up the cracks). The micro-drainage from soil in the catchment of Lake 8 has very low absorption values at all wavelengths. The soil is locally of the brown soil type and the vegetation was in full spring activity at the sampling time. The absorption characteristic in this case may be explained by small amounts of humic substances, iron and manganese available for leaching and active sorption of ions, especially nutrients ( $\text{NO}_3$ ), by the vegetation. The ultraviolet absorption characteristic of natural waters seems mainly to be influenced by the humic substances (iron and manganese) at 220-320 nm and by nitrate at about 210 nm (Grøterud in prep.). Vik (1982) has described a close relation between the ultraviolet absorption at 253.7 nm and total organic carbon and water colour as mg Pt/l.

### 11. Water quality and lake ecology

The lake area is pointed out by SNSF (1976) as one of the areas being severely affected by acidification.

Consequently it is not unexpected to find a water quality as given in Table 4. The water is acid, poor in salts (Ca) and available nutrients (P), rich in sulphate and aluminium (sporadic measurements the last years indicate 50-90% labile Al) and more or less coloured. Lake 13 is an exception from the general water quality picture. Differing especially are pH, conductivity (salt concentration), Ca, Si (higher values) and Al (lower value). The general water quality in the area is primarily due to the precipitation quality, geology, soil and vegetation.

The ultraviolet absorption characteristics of waters from two lakes (one clear and one humic) in the spring have been determined and are shown in Figures 19 and 20. Waters upon the ice surface have also been analysed, and their characteristics show the highest absorption values for all the wavelengths measured. This could be mainly due to high concentrations of humic matter, iron, manganese and nitrate (Grøterud in

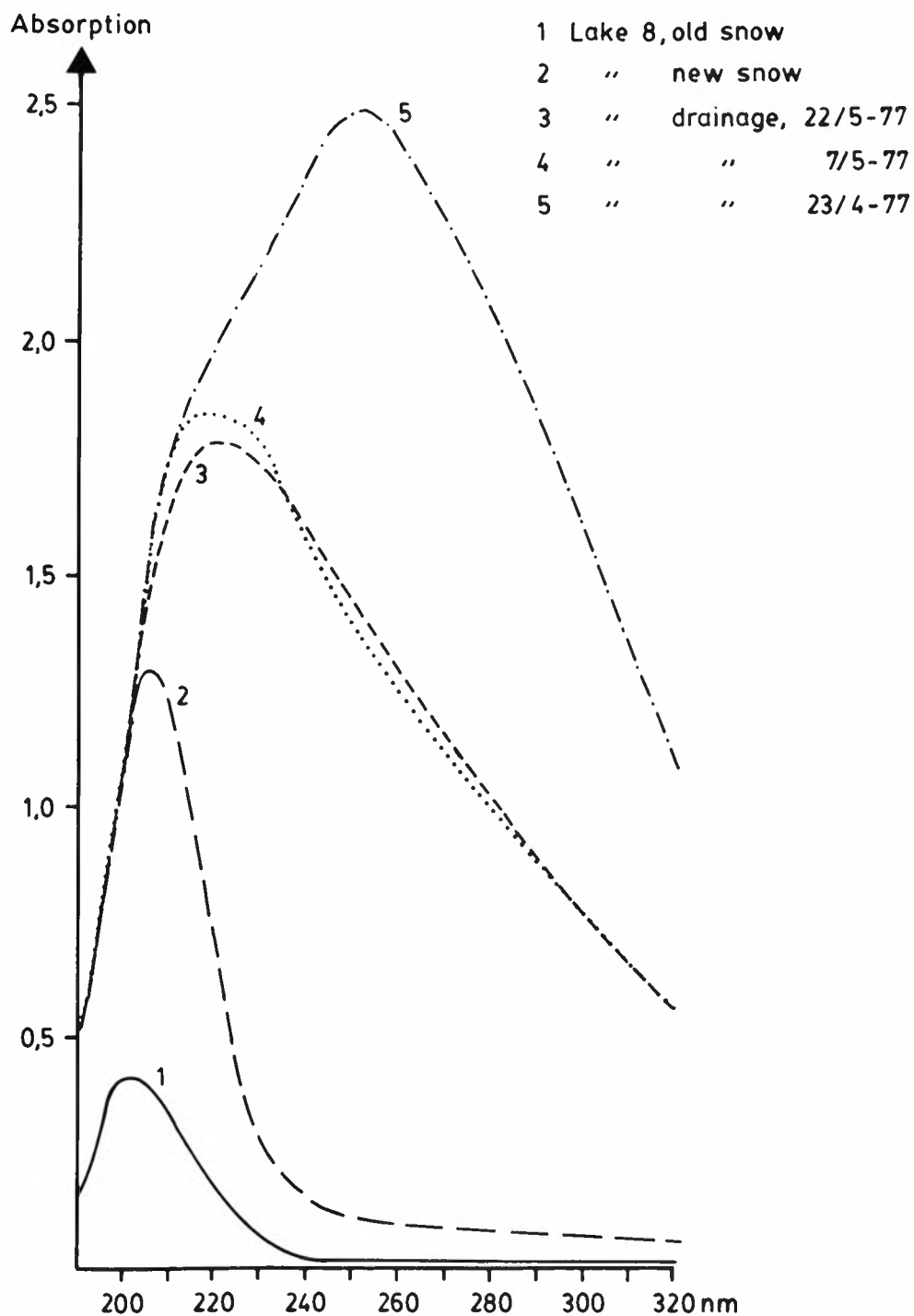

Fig. 17. Ultraviolet light absorption characteristics of different drainage water and relatively new and old snow.

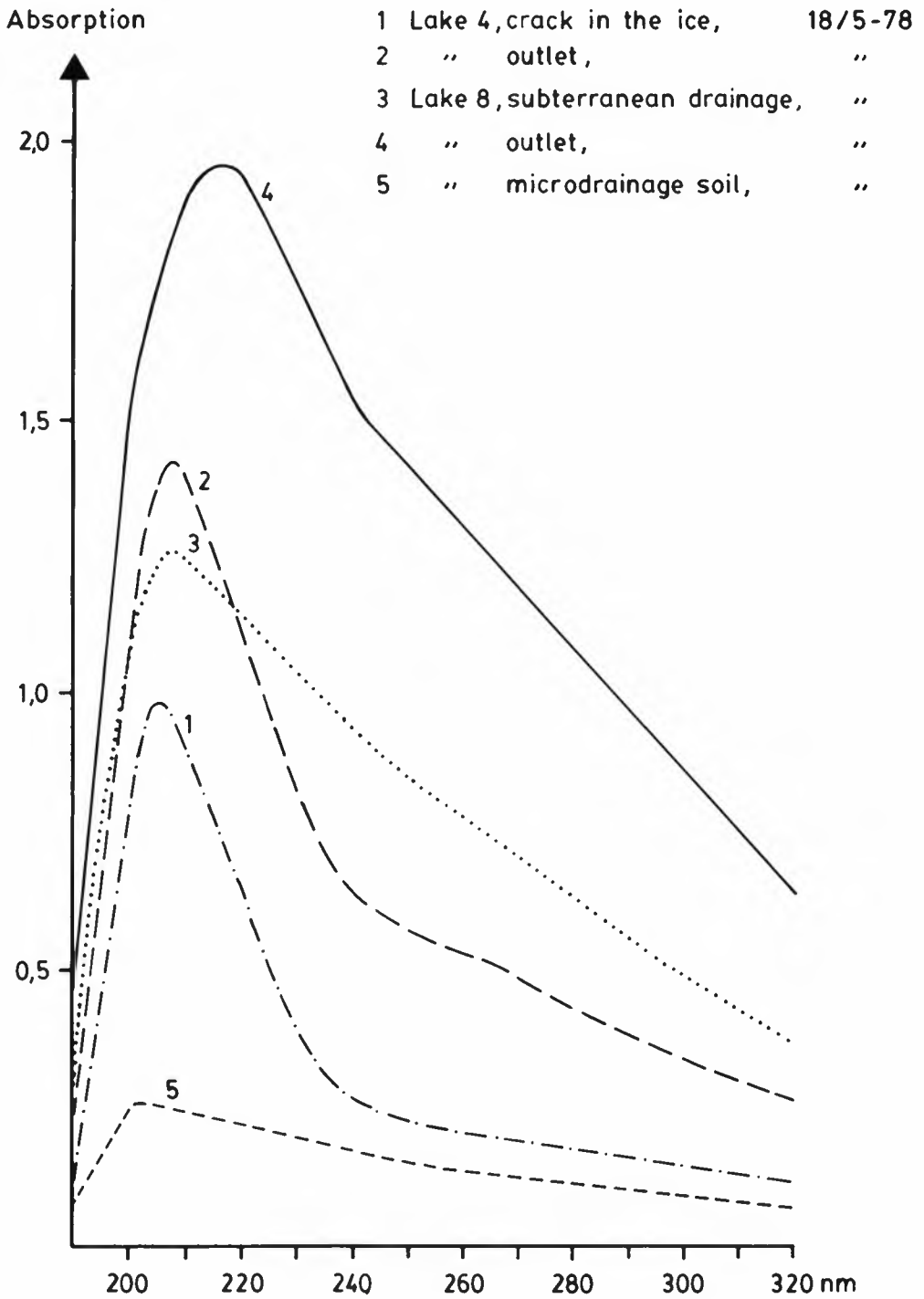

Fig. 18. As Fig. 17, but for some other water types.

prep.), which again are caused by meltwater influence and freezing-out effects (Grøterud 1978). The characteristics of the diluted samples (Fig. 19) indicate that the absorption values of the humic matter, iron and manganese (wavelengths 240-320 nm) are relatively more reduced than the absorption values for the nitrates (wavelengths about 210 nm). Consequently, dilutions complicate the interpretation of the absorption characteristics (Grøterud in prep.). The decreased absorption values from the ice surface water down into the deep water for Lake 1 (Fig. 19) seem to primarily reflect the decreased concentration of humic matter (Fe, Mn). In Lake 3 (Fig. 20) nitrate is reflected in a similar way. But both components are inevitable of importance for a more complete interpretation of the absorption characteristics of the two lake waters.

The "humic loading" on the lakes, expressed as Pt colour, is indicated by the terrestrial catchment/lake area ratio as shown by Fig. 96. The values of  $A_d/A_0$  and colour in Table 2 and 4 respectively seem to be in accordance with that. The "humic influence rate" on the lakes, expressed as Pt colour, should be indicated by the terrestrial catchment/lake volum ratio ( $A_d/V$ ) as shown in Table 2. E. g. Lakes 2, 4 and 15 should increase the lake water colour faster than the other lakes in the flood periods. This is also in accordance with the experiences.

There are few polluting activities in the catchments. The moderate liming of the lakes 4 and 10 should be mentioned. Lake 4 has been limed since 1968 and up to the present. In the period 1968-81 the lake received about 1700 kg  $\text{Ca}(\text{OH})_2$ , 1500 kg limestone powder and 12000 kg limestone. Lake 10 mainly received limestone along the littoral zone in the north. The amount is not recorded. Compared with the other acid lakes these two lakes reflect the liming with a moderately higher pH. Lake 4 and Lake 13 (not acidified) have relatively small concentrations of labile Al, namely about 50 and 30  $\mu\text{g/l}$  respectively.

The fish seems to have disappeared in most lakes due to the high acidity and concentrations of Al (labile Al). Lakes 4 and 13 have brown trout and perch, Lake 5 possibly perch and Lake 10 perch and possibly brown trout. The extinction of fish stocks in the lakes may have started 50 years ago, according to information from local elderly people.

A sporadic and rough investigation by the author of algal species indicated few in the acid lakes. A conspicuous phenomenon in these lakes is the relatively great invasion of filamentous algae, mosses and fungi on the bottom. This algal accumulation at low pH is probably due to reduced grazing by invertebrates and decreased decomposition. Few phytoplankton species in acid water are probably caused by specific intolerance to acid conditions or other associated chemical changes (Hendry et al. 1976). The invasion of mosses (*Sphagnum*) seems to outgrow the flowering plants in the acid lakes investigated. *Sphagnum* moss is acidophilous and utilizes  $\text{CO}_2$  instead of  $\text{HCO}_3^-$ , which is used by many other aquatic plants. *Sphagnum* mats have also been described in some acid southern Norwegian lakes (Halvorsen 1977), in some Swedish lakes (Grahn et al. 1974) and in USA (Hendrey & Vertucci 1980). In the investigated clear water lakes (Nos. 3, 4, 5, 7, 12, 14) the mosses and algal mats seem to have invaded bottom areas previously dominated by *Lobelia* species. Laake (1976) has shown experimentally that the growth of *Lobelia dortmanna* L. was inhibited at pH 4.0 compared to higher pH.

Gelatinous masses of fungi seem to be the most eye-catching in the humic lakes studied. Several investigations give evidence of shifts from bacterial to fungal decomposi-

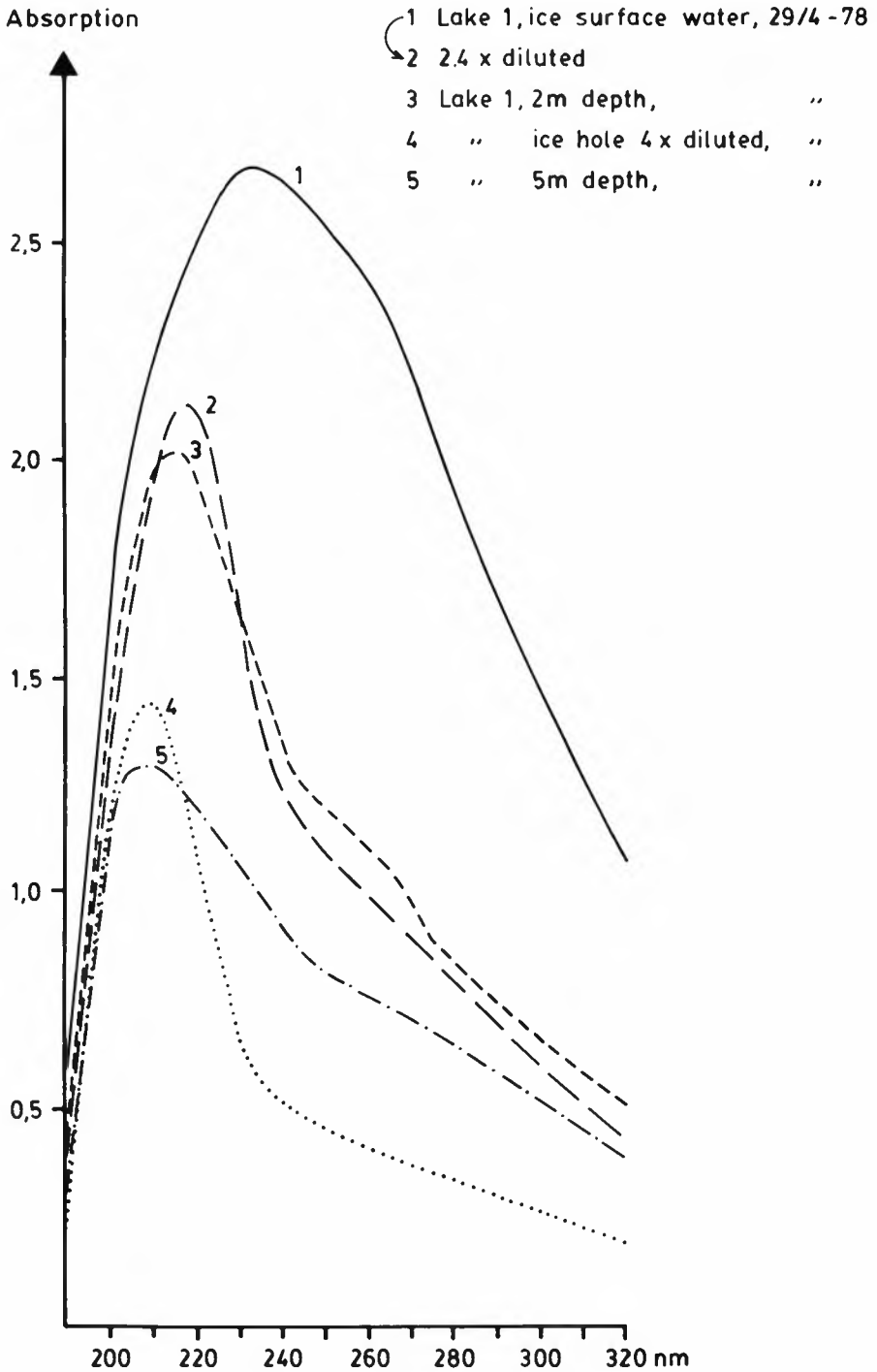

Fig. 19. Ultraviolet light absorption characteristics of different waters from Lake 1. Two water samples have been diluted with distilled water before measurements.



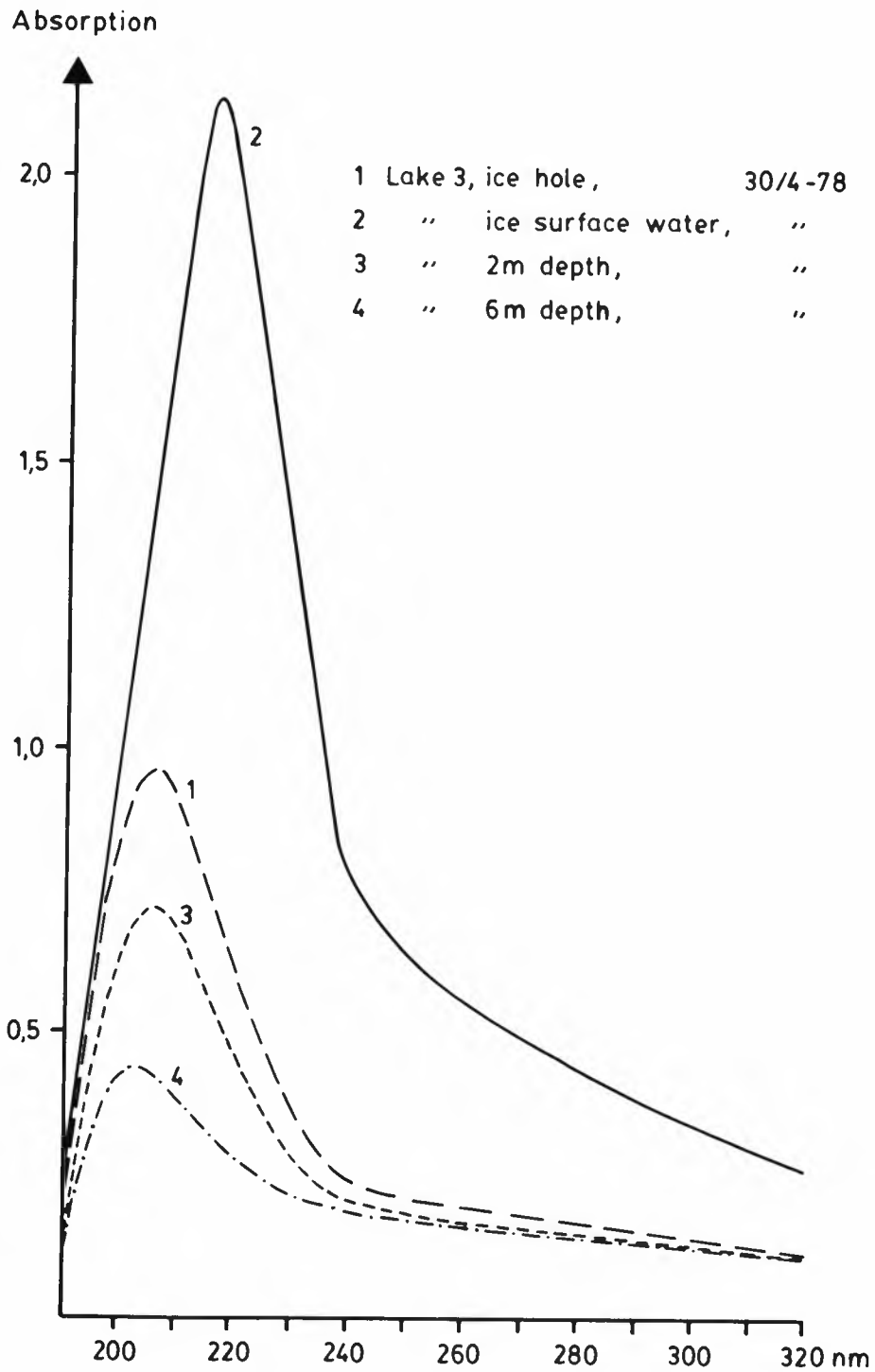

Fig. 20. As Fig. 19, but for Lake 3.

Table 4. The water chemistry of the lakes given as the highest and lowest values recorded in the outflow during 1st Oct. 1977 - 30 Sept. 1980

Parameter	Lake 1	Lake 2	Lake 3	Lake 4	Lake 5
pH	4.35 - 4.80	4.15 - 4.50	4.40 - 4.75	4.80 - 5.80	4.75 - 5.0
Colour, mg Pt/l	15 - 45	40 - 70	<5 - 15	<5 - 15	<5 - 10
K <sub>20</sub> , $\mu$ S/cm	18.2 - 23.5	20.8 - 32.5	16.5 - 20.2	11.0 - 18.5	13.1 - 19.0
SO <sub>4</sub> , $\mu$ eq/l	73 - 123	94 - 135	79 - 110	67 - 100	73 - 115
Cl, $\mu$ eq/l	11 - 17	11 - 17	11 - 18	11 - 18	11 - 18
NO <sub>3</sub> , $\mu$ eq/l	2 - 7	3 - 7	1 - 8	1 - 7	1 - 7
Ca, $\mu$ eq/l	15 - 30	10 - 28	10 - 20	30 - 60	40 - 70
Mg, $\mu$ eq/l	17 - 30	8 - 30	17 - 34	17 - 49	17 - 58
Na, $\mu$ eq/l	17 - 26	17 - 26	17 - 26	17 - 31	20 - 48
K, $\mu$ eq/l	6 - 10	8 - 15	7 - 10	8 - 10	6 - 10
Total P, $\mu$ g/l	9 - 13	10 - 15	5 - 8	7 - 10	3 - 5
PO <sub>4</sub> -P, $\mu$ g/l	<2 - 4	<2 - 3	<2 - 3	<2 - 5	<2 - 4
NH <sub>4</sub> , $\mu$ eq/l	1 - 13	2 - 7	1 - 21	1 - 25	2 - 15
Al, $\mu$ g/l	180 - 280	270 - 420	126 - 174	60 - 110	130 - 240
Fe, $\mu$ g/l	106 - 308	200 - 390	94 - 166	65 - 115	110 - 210
Mn, $\mu$ g/l	26 - 108	35 - 150	17 - 62	10 - 52	15 - 95
Si, mg/l	0.3 - 0.6	0.9 - 1.3	0.2 - 0.5	0.2 - 0.5	0.3 - 0.7

Table 4 (cont.) The water chemistry of the lakes given as the highest and lowest values recorded in the outflow during 1st Oct. 1977 - 30 Sept. 1980

Parameter	Lake 6	Lake 7	Lake 8	Lake 9	Lake 10
pH	4.35 - 4.75	4.32 - 4.75	4.25 - 4.65	4.40 - 4.80	4.75 - 5.50
Colour, mg Pt/l	15 - 35	5 - 35	40 - 65	20 - 50	10 - 30
K <sub>20</sub> , $\mu$ S/cm	18.5 - 23.8	15.1 - 24.0	17.0 - 25.2	16.9 - 22.7	17.5 - 23.6
SO <sub>4</sub> , $\mu$ eq/l	75 - 125	83 - 121	88 - 131	75 - 123	79 - 113
Cl, $\mu$ eq/l	11 - 18	11 - 18	11 - 19	11 - 18	11 - 18
NO <sub>3</sub> , $\mu$ eq/l	3 - 7	1 - 7	3 - 8	2 - 7	1 - 5
Ca, $\mu$ eq/l	15 - 30	10 - 20	10 - 20	15 - 30	40 - 55
Mg, $\mu$ eq/l	17 - 56	17 - 41	8 - 25	17 - 41	41 - 58
Na, $\mu$ eq/l	17 - 26	17 - 26	17 - 26	17 - 26	26 - 39
K, $\mu$ eq/l	18 - 22	7 - 10	5 - 10	8 - 13	8 - 11
Total P, $\mu$ g/l	9 - 12	5 - 8	11 - 15	9 - 13	3 - 6
PO <sub>4</sub> -P, $\mu$ g/l	<2 - 4	<2 - 3	<2 - 3	<2 - 4	<2 - 2
NH <sub>4</sub> -N, $\mu$ eq/l	1 - 10	1 - 16	2 - 8	1 - 15	1 - 10
Al, $\mu$ g/l	170 - 300	180 - 300	267 - 338	170 - 305	195 - 309
Fe, $\mu$ g/l	112 - 295	135 - 285	278 - 351	150 - 285	212 - 269
Mn, $\mu$ g/l	25 - 100	20 - 105	41 - 166	35 - 120	29 - 104
Si, mg/l	0.8 - 1.2	0.3 - 1.1	1.1 - 1.4	0.4 - 0.9	1.3 - 1.6

Table 4 (cont.) The water chemistry of the lakes given as the highest and lowest values recorded in the outflow during 1st Oct. 1977 - 30 Sept. 1980

Parameter	Lake 11	Lake 12	Lake 13	Lake 14	Lake 15
pH	4.15 - 4.40	4.45 - 4.85	6.80 - 7.35	4.50 - 4.85	4.15 - 4.80
Colour, mg Pt/l	45 - 75	<5 - 15	10 - 35	<5 - 20	15 - 50
K <sub>20</sub> , $\mu$ S/cm	22.1 - 31.0	14.9 - 20.5	35.4 - 54.1	18.2 - 21.0	16.9 - 33.0
SO <sub>4</sub> , $\mu$ eq/l	96 - 135	77 - 113	117 - 135	79 - 108	81 - 135
Cl, $\mu$ eq/l	11 - 17	11 - 17	14 - 20	11 - 18	11 - 17
NO <sub>3</sub> -N, $\mu$ q/l	2 - 7	2 - 8	1 - 5	2 - 7	1 - 8
Ca, $\mu$ eq/l	10 - 20	10 - 25	395 - 475	15 - 30	15 - 30
Mg, $\mu$ eq/l	17 - 35	17 - 35	41 - 66	25 - 41	25 - 50
Na, $\mu$ eq/l	17 - 26	17 - 26	44 - 54	17 - 26	17 - 30
K, $\mu$ eq/l	10 - 14	8 - 10	11 - 15	7 - 9	6 - 8
Total P, $\mu$ g/l	14 - 19	4 - 6	6 - 10	5 - 10	11 - 16
PO <sub>4</sub> -P, $\mu$ g/l	<2 - 3	<2 - 4	<2 - 3	<2 - 3	<2 - 3
NH <sub>4</sub> -N, $\mu$ q/l	3 - 8	1 - 18	2 - 7	1 - 14	1 - 12
Al, $\mu$ g/l	290 - 440	175 - 290	50 - 130	140 - 230	120 - 290
Fe, $\mu$ g/l	230 - 390	105 - 210	130 - 200	120 - 235	150 - 290
Mn, $\mu$ g/l	50 - 180	19 - 72	22 - 65	19 - 72	24 - 100
Si, mg/l	0.8 - 1.4	0.3 - 0.6	2.0 - 2.8	0.3 - 0.5	0.6 - 0.8

tion with acidification (Bick & Drews 1973, Hobæk & Raddum 1980, Laake 1976). Fungal decomposition is slower than bacterial according to laboratory experiments (Overrein et al. 1980). Liming experiments in acid lakes indicate increased microbiological activity and accelerated organic decomposition (Baalsrud et al. 1985). Liming also results in reduced growth of mosses and algae (Hultberg & Andersson 1982). The number of zooplankton species (crustaceans, rotifers, *Chaoborus* larvae) seem according to some observations by the author to be small in acid lakes, especially in the clear water lakes. The cladocerans are apparently most affected by acid conditions. The absence of fish predators and rate of physiological tolerance are probably important factors in explaining the zooplankton occurrence. The observations reported here are in accordance with Overrein et al. (1980) and Baalsrud et al. (1985).

Like the zooplankton, the aquatic insects in this research (Ephemeroptera, Trichoptera) seem to exhibit a relatively small number of species in acid lakes. While some species disappear, others seem to utilize the advantages of reduced competition. An example is the great number of water boatmen (*Corixidae*) observed in acid lakes. This phenomenon is due to reduced fish predation and high physiological tolerance to acid water (Vangenechten et al. 1979). Others in great numbers in acid lakes are beetles (Coleoptera) and dragonflies (Odonata), as expected (Mossberg & Nyberg 1979, Nilsen 1980).

Crustaceans, snails and mussels are only found in Lake 13. This is primarily due to the favourable pH and Ca in this lake (see Økland 1983).

The physico-chemical states of some of the lakes have been described previously (Grøterud 1971 a, b, 1972 a, b, c, 1973), and only sporadic investigations during the research period have been carried out in all the lakes. Lakes 2, 4, 5, 8, 10 and 13 have shown anaerobic conditions in the bottom water (about 1 m above the sediments at maximum depth) at the end of at least one winter during the research period. These lakes, with the exception of Lake 4 and partly 13, have greater relative depths (see Table 2). Lake 13 is not acid and Lake 4 has been limed. Both lakes seem to be more productive than the other lakes mentioned. The latter statement is based upon chlorophyll a determinations in the summer season, which have given mean values of 2.3 µg/l for the two lakes in question, 2.0 µg/l in Lake 14 and < 2 µg/l for the other 12 lakes.

A relatively permanent thermal stratification during summer has been observed in all the lakes except Lakes 4, 11 and 15 (shallow lakes). Only Lake 10 (deep lake) has the temperature of maximum density in the bottom water throughout the year.

The lakes in the reference area (see Fig. 7) have been investigated sporadically during the research period. The following values have been obtained: pH = 5.8-6.8,  $\kappa_{20}$  = 18.6-62.5 µS/cm,  $\text{SO}_4$  = 121-206 µeq/l, Ca = 100-400 µeq/l, colour = 20-75 mg Pt/l, reactive Al = 65-125 µg/l, labile Al = 10-50 µg/l. Although this area has been described geologically (felsic rocks) as a sensitive area (Overrein et al. 1980), there are no clear indications of acidification so far. It is interesting to note that the sulphate values are higher here than in the acidified lakes. If the precipitation supply of  $\text{SO}_4$  is equal in the two areas in question (which there is good reasons to believe), the catchment must supply  $\text{SO}_4$  to the reference lakes.

Perch, brown trout and minnow are supposed to exist in most reference lakes.

#### IV. HYDROLOGY

##### 1. Precipitation measurements and estimations

The precipitation recordings were started at Lake 4 (about 600 m above sea level) October 1st, 1970. The results are given in Table 5. The registrations were done continuously until 1976. As previously mentioned the Norwegian Meteorological Institute recommended using its Fossum station in Modum in the project. This station lies approximately 10 km south of the research area, 58 m above sea level. The monthly data from this station, in Fig. 21, and the data in Table 5 are used to make a regression analysis. This analysis gives the equation

$$y = 1.39 X + 4.84$$
$$r = 0.979, n = 63, p < 0.001$$

where  $y$  = precipitation at Lake 4 station and  $X$  = precipitation at Fossum station.

The correlation coefficient indicated that the precipitation at Lake 4, and consequently the precipitation in the neighbouring lakes, could be calculated by the regression equation mentioned. This has been done for 1977 (last three months), 1978, -79 and -80 as shown in Table 5. The yearly sum is given both for the calendar year and the hydrologic year (1st October - 30th September). The latter is favourable when considering the water balance for a whole year, due to the fact that snow is an important part of the precipitation in Norway and that this snow in most years has disappeared by October 1st. The hydrologic year is not usually used in Norway, as in the rest of Europe, but this has been recommended (Otnes & Ræstad 1978).

The data in Table 5 are differentiated into snow and rain, to better examine the precipitation accumulation and storage and the potential spring flood in the catchments. As seen in the table, the hydrologic year in 1970/71 has relatively much precipitation as snow and in 1972/73 relatively little.

As already mentioned the precipitation station at Lake 4 was moved in 1976 to Lake 1 (about 640 m above sea level) in connection with the establishment of a field laboratory. The data from this station, which were recorded continuously until 1983, were considered together with the corresponding data from the meteorological station Fossum in Modum in a regression analysis which resulted in the equation

$$y = 1.43 X + 1.93$$
$$r = 0.973, n = 87, p < 0.001$$

where  $y$  = precipitation at Lake 1 station and  $X$  = precipitation at Fossum station.

The correlation coefficient indicated that the precipitation at Lake 1, and consequently the precipitation in the neighbouring lakes, could be calculated by the regression equation found. By comparing the data from the two precipitation stations in the research area, it seems quite clear that they are covarying and that the values from Lake 1 are somewhat higher (about 2.5%) than from Lake 4. This is probably due to the difference in height above sea level and east-west position. The precipitation amounts increase generally with height (Otnes & Ræstad 1978).

Table 5. Precipitation values in mm measured at Lake Sandtjern (4). Values from October 1977 - December 1980 are calculated by using the regression equation  $y = 1.39x + 4.84$  where  $y =$  Lake Sandtjern (4) and  $x =$  Fossum meteorological station. Hydrologic year: 1st October - 30th September, s = snow and ps = partly snow (50% snow when adding up in the hydrologic year).

	Jan.	Feb.	March	Apr.	May	Jun.	July	Aug.	Sep.	Oct.	Nov.	Dec.	Hydrologic year		
													Snow	Tot.	
1970										90ps	240ps	40s	549	495	1044
1971	58s	58s	65s	43s	70	65	172	88	55	58	84s	56s	405	601	1006
1972	51s	46s	86s	92s	70	144	72	170	87	20	21s	74s	256	606	862
1973	50s	30s	26s	55s	100	61	171	94	160	14	97s	74s	357	440	797
1974	76s	50s	60s	0	35	46	85	65	195	192	151s	58s	435	504	939
1975	140s	16s	40s	30s	40	16	45	86	125	75	77s	41s			
1976															
1977										101	131	116			1169
1978	112	81	99	31	37	72	174	98	117	28	44	40			900
1979	48	30	94	83	105	74	119	166	69	112	131	76			890
1980	41	45	44	10	109	92	84	70	76	177	54	62			864

Table 6. Precipitation values in mm measured at Lake Store utg. tjern (1). Hydrologic year: 1st October - 30th September, s = snow and ps = partly snow (50% snow when adding up in the hydrologic year).

	Jan.	Feb.	March	Apr.	May	Jun.	July	Aug.	Sep.	Oct.	Nov.	Dec.	Hydrologic year		
													Snow	Tot.	
1975										85	66s	43s	200	288	488
1976	30s	41s	5s	15s	50	36	28	3	86	306ps	162s	75s	779	630	1409
1977	121s	51s	90s	127s	44	151	119	72	91	112	153s	117s	579	630	1209
1978	100s	80s	100s	29s	37	81	169	107	124	26	45s	37s	323	573	896
1979	46s	28s	88s	85s	107	85	130	154	71	109ps	126s	81s	378	506	884
1980	36s	40s	40s	6	112	100	80	75	79	174ps	60s	61s	308	380	688
1981	16s	16s	65s	5ps	86	90	75	40	65	105	130s	75s	415	620	1035
1982	45s	35s	80s	50s	155	40	75	75	170	145s	164s	111s			

The values shown in Table 6 bear witness to great variations in the yearly quantity of precipitation, especially with regard to snow. The total precipitation of 1409 mm (snow = 779 mm) in the hydrologic year 1976/77 is 2.9 times more than in the year 1975/76, with a total precipitation of 488 mm (snow = 200 mm). The ratio for the snow is even higher (3.9).

## 2. Runoff measurements and estimations

The runoff from Lake 9 is, as previously mentioned, regulated for power production. The basin is filled up during the spring, summer and autumn and the dam gate opened for runoff in the beginning of the winter (see Grøterud 1984b).

The main measurements of runoff were carried out from Lakes 2, 4 and 13. The results are given in Figs. 22, 23 and 24. The runoff pattern is rather typical for continental catchments, with two marked floods in spring and autumn, the greatest in spring. Some deviations from this pattern are also obvious in the figures mentioned, e.g. the values in 1974 show the greatest flood in autumn and in 1978 the graphs shows three floods where the summer flood was the next greatest. The monthly and annual variations in runoff are relatively high, reflecting the small reservoirs in the catchments. This is due to small ground water reservoirs which are in general of relatively great significance for moderating the runoff variations in catchments. The small amounts of ground water are estimated in relation to the geology and soil previously described in the area. According to the literature (e.g. Englund 1980) small ground water resources are expected in this kind of geology. The runoff relations between six lakes (Fig. 25), and especially two lakes and one terrestrial catchment (Fig. 26), bear witness to small runoff delays in the research area. This is another indication of small ground water reservoirs in the lakes' catchments. However, experiences from localizing small brooklets in the catchments on rainy days have given indications of some ground water flows in the catchments of Lakes 5 and 10. This has also been revealed in some other ways (see chapter VII).

The runoff relation between Lake 4 and neighbouring lakes (Lakes 5, 6, 7, 8 and 12) is elucidated by Fig. 25. This figure indicates that the monthly runoff from the neighbouring lakes could be calculated by using the monthly values in mm from Lake 4. A similar relation is shown by Fig. 26. The values for the neighbouring catchments (Lake 3 and the reference catchment) seem to be somewhat higher than for Lake 2 for small runoff values (< 50-100 mm/month) and somewhat lower for great runoff values (> 50-100 mm/month). This relation indicates, in spite of the discrepancy mentioned, that the monthly runoff from Lake 2 could be used in calculating the monthly values in mm from the neighbouring lakes. The relation between runoff and precipitation on an annual basis is estimated by means of regression analyses. For the five hydrologic years 1970/71-1974/75 the regression equation was

$$y = 1.05 X - 383$$

$$r = 0.93, n = 5, p < 0.05$$

where  $y$  = runoff from Lake 4 and  $X$  = precipitation from the station at Lake 4. This relation is presented in Fig. 27, where also runoff from neighbouring lakes for one or two hydrologic years is included.

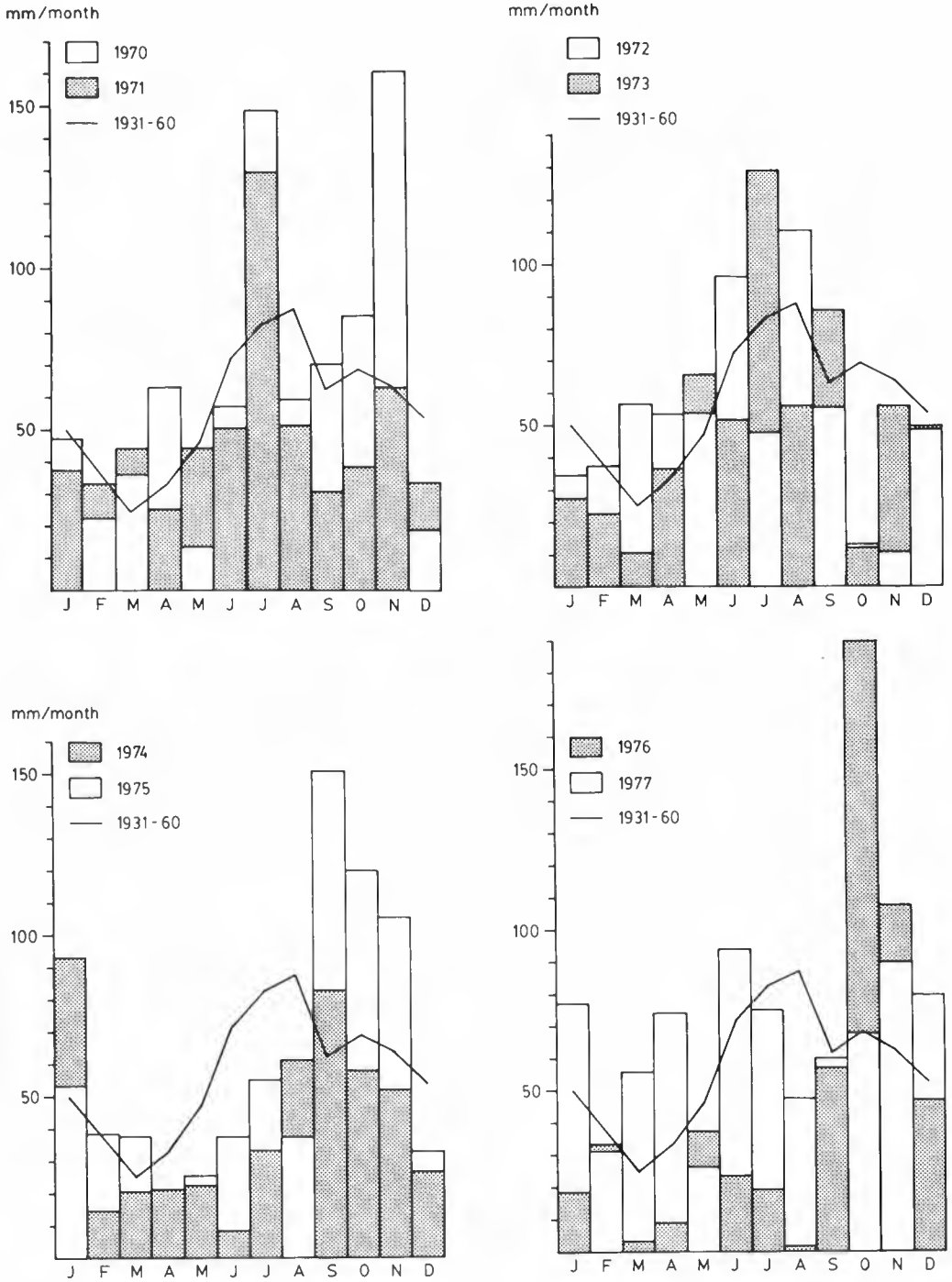
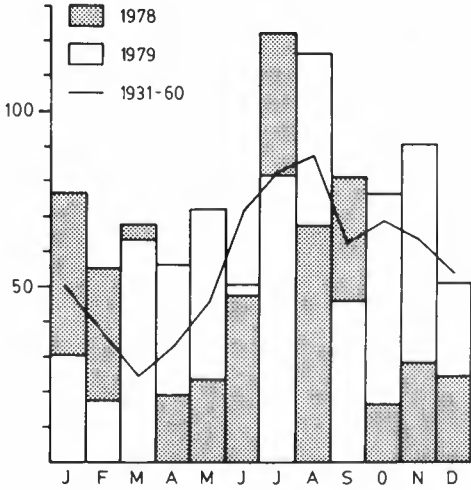

Fig. 21. Monthly precipitation in the normal (1931-60) and research (1970 - 82) periods.



mm/month



mm/month

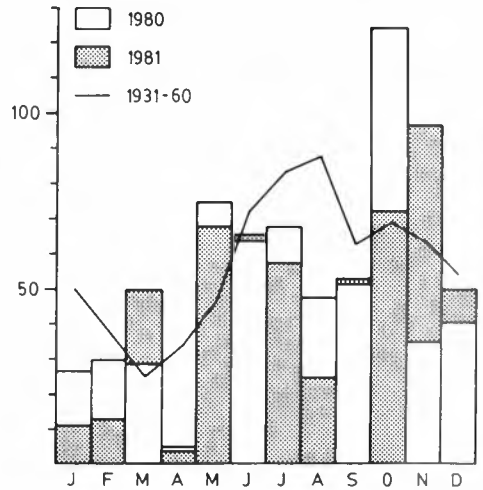

mm/month

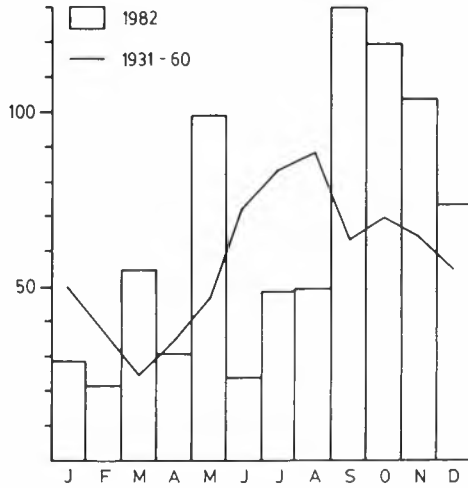

Run-off  
Lake 4  
mm/month

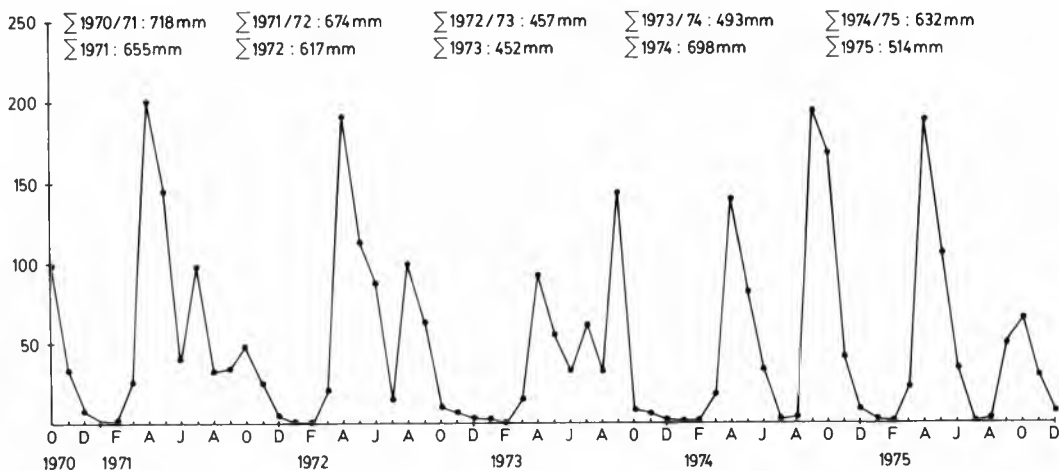

Run-off  
Lake 4  
mm/month

$\sum$ 1977/78 : 923mm	$\sum$ 1978/79 : 602mm	$\sum$ 1979/80 : 499mm
$\sum$ 1978 : 812mm	$\sum$ 1979 : 647mm	$\sum$ 1980 : 533mm

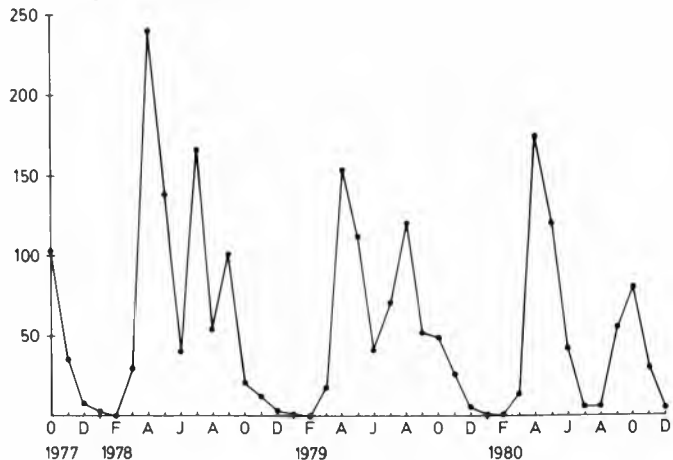

Fig. 22. Monthly runoff data from Lake 4. The annual sum is given for both the calendar and hydrologic (1st October - 30th September) years.

Run-off  
Lake 2  
mm/month

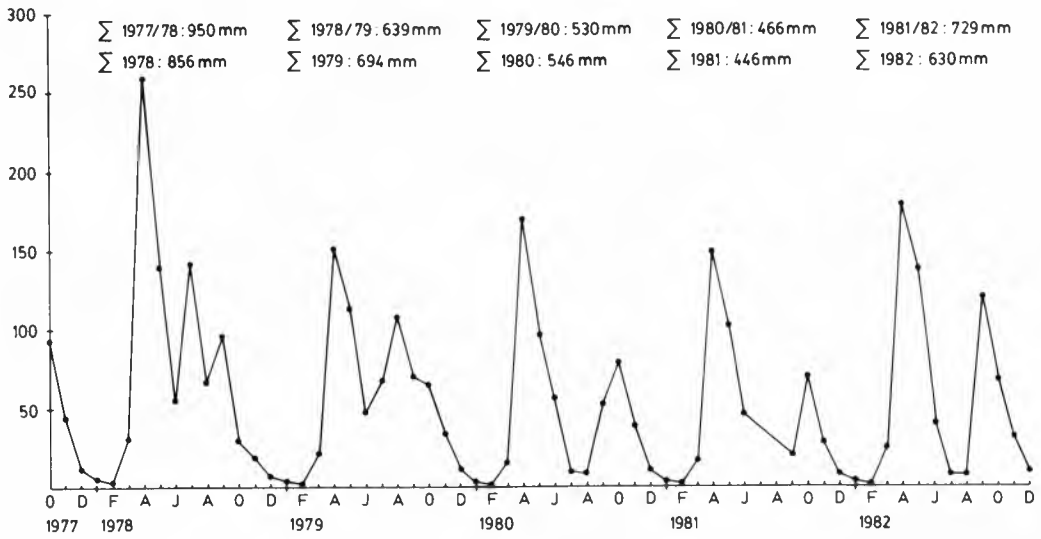

Fig. 23. As Fig. 22, but for Lake 2.

Run-off  
Lake 13  
mm/month

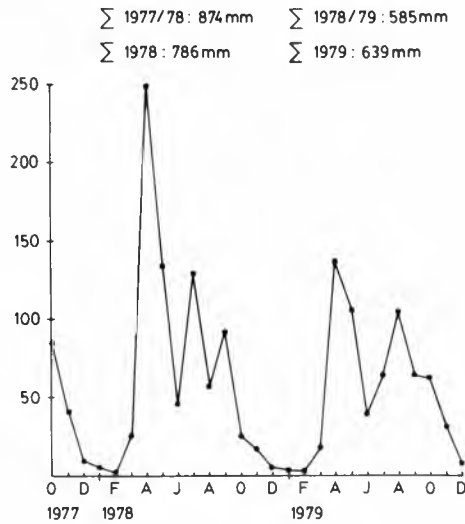

Fig. 24. As Fig. 22, but for Lake 13.

Run off from  
Lake Sandtjern (4)  
mm/month

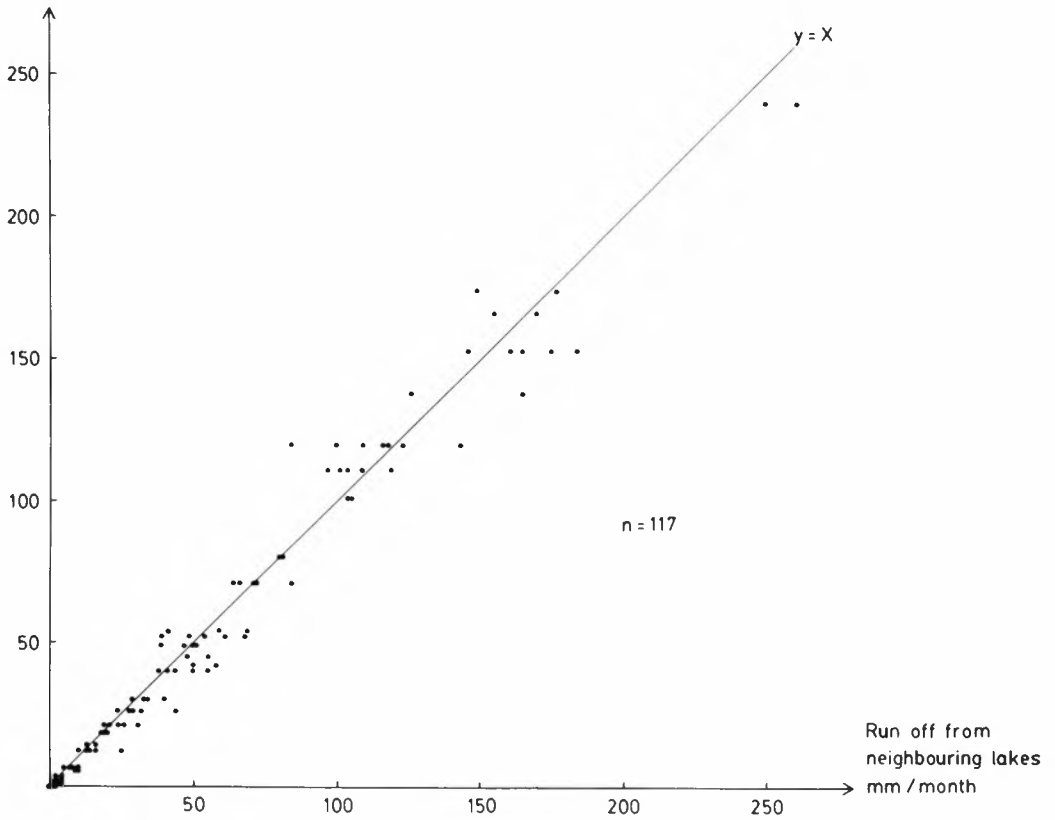

Fig. 25. The runoff relation between Lake 4 and some neighbouring lakes. The line represents equal proportions.

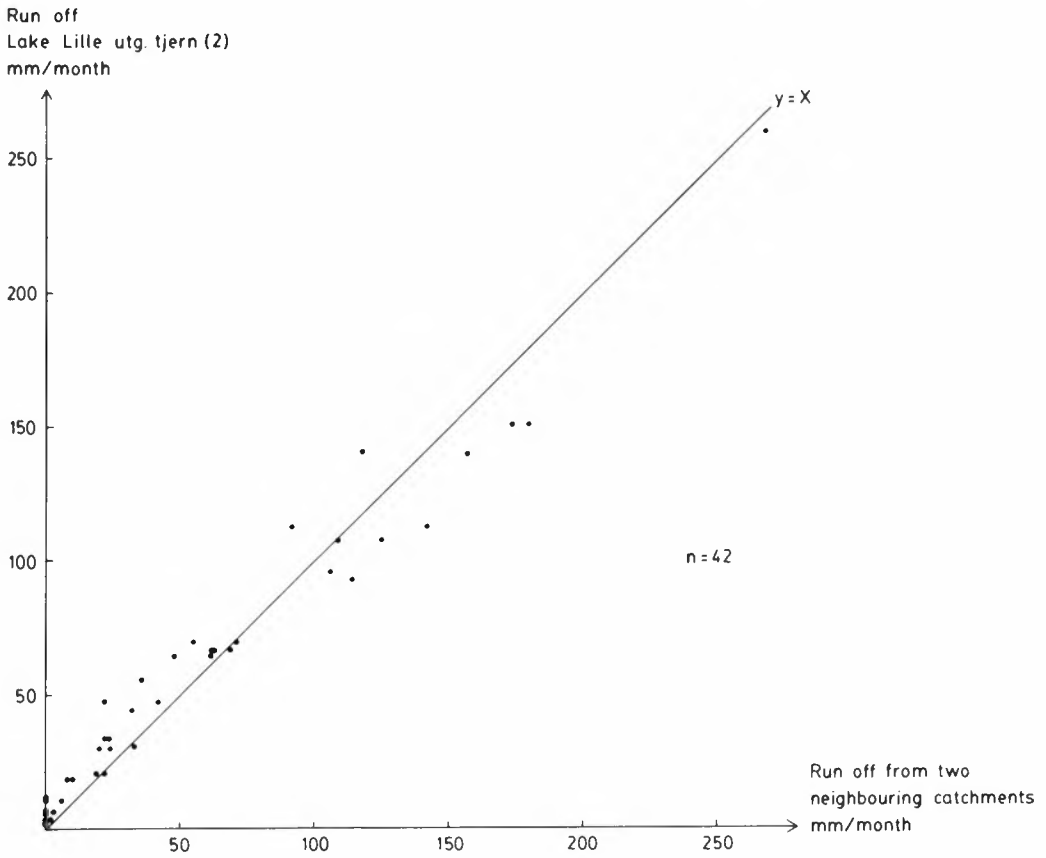

Fig. 26. The runoff relation between Lake 2 and two neighbouring catchments. The line represents equal proportions.

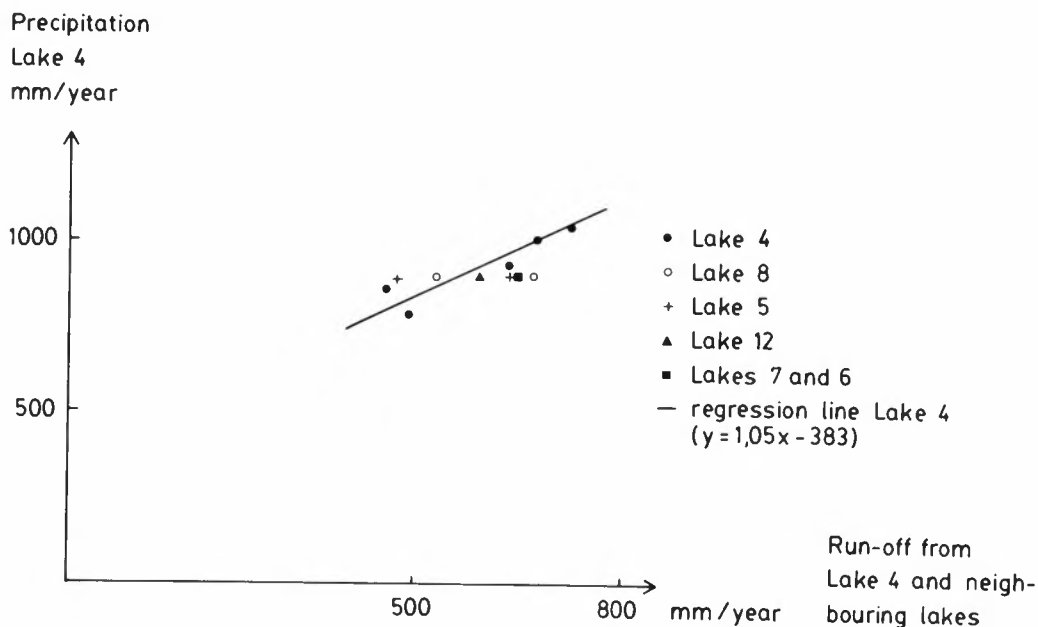

Fig. 27. The relation between runoff and precipitation on an annual basis for Lake 4 where also runoff from neighbouring lakes is included.

The relation between runoff from Lake 4 and the meteorological station Fossum, for the same five hydrologic years as mentioned above and in addition the three years 1977/78-1979/80, is elucidated by the two regression equations

$$y = 1.52 X - 352 \text{ (1970/71 - 74/75)}$$

$$r = 0.96, n = 5, p < 0.01$$

$$y = 1.73 X - 485 \text{ (1970/71 - 75/75, 1977/78 - 79/80)}$$

$$r = 0.97, n = 8, p < 0.01$$

where  $y$  = runoff from Lake 4 and  $X$  = precipitation from Fossum station.

The regression equations and graphical presentations given here point out that the annual runoff from the lakes in the research area could be satisfactorily calculated by using the annual precipitation values from the meteorological station Fossum in Modum. To be correct, the calculated values for the lakes situated in the neighbourhood of the precipitation station at Lake 1 (and Lake 2) should be increased by 2.5 % (the difference between this station and the station at Lake 4). But in a practical connection it is questionable whether this correction is adequate due to the relatively great uncertainty incorporated in a regression equation.

The size of the spring flood into lakes is very often of decisive importance in estimating the water quality development. This applies especially to lakes with high and varying concentrations of hydronium ions and aluminium (labile Al). Most lakes in this project are of this kind. Therefore the regression equation for the runoff sum from Lake 4 and

the precipitation sum recorded at the meteorological station Fossum in Modum during the eight months from October 1st - May 31st was calculated. The same eight years as for the above calculated regression equation were used. The regression equation was

$$y = 1.52 X - 159$$

$$r = 0.99, n = 8, p < 0.01$$

$y$  = runoff at Lake 4 station and  $X$  = precipitation at Fossum station. This equation may express the potential spring flood.

One striking feature of the regression equations is that the correlation coefficient is actually higher for the relation between runoff from Lake 4 and precipitation at Fossum station than for the relation between runoff from Lake 4 and precipitation at Lake 4 station. This is unreasonable and difficult to explain. It could perhaps be due to better precipitation measurements at the meteorological station Fossum in Modum than at the precipitation station at Lake 4.

*Standard (normal) runoff values* from the lakes will be of interest in a comparative connection. Due to lack of data, these standard values have been determined in an unusual way. The annual mean runoff for Lake 4 in the eight hydrologic years 1970/71-1974/75 and 1977/78-1979/80 was calculated to 625 mm ( $Q_{4,8}$ ). This value was assumed to be the standard runoff value for the Lakes 4, 5, 6, 7, 8, 10, 12 and 14, which all are supposed to belong to the same hydrologic regime (see Figs. 7 and 25). The annual mean runoff for Lakes 2 and 4 in the three hydrologic years 1977/78-1979/80 was calculated to 702 ( $Q_{2,3}$ ) and 675 mm ( $Q_{4,3}$ ) respectively. The standard value for Lake 2 was then

$$Q_{4,8} \frac{Q_{2,3}}{Q_{4,3}} = 625 \frac{702}{675} = 650 \text{ mm } (Q_{2,8})$$

which was assumed to be the standard runoff value for the Lakes 1, 2, 3, 9, 11 and 15. These lakes are assumed to belong to the same hydrologic regime (see Fig. 17). The annual mean runoff for Lake 13 in the two hydrologic years 1977/78-1978/79 was calculated to 730 mm ( $Q_{13,2}$ ) and for Lake 2 in the same two years to 791 mm ( $Q_{2,2}$ ). The standard runoff value was then

$$Q_{2,8} \frac{Q_{13,2}}{Q_{2,2}} = 650 \frac{730}{791} = 600 \text{ mm}$$

### 3. Evapotranspiration measurements and estimations

This quantity is governed by direct evaporation from different surfaces in the catchments, especially from lake surfaces, and by transpiration through the plant organisms. Consequently evaporation is closely connected to the temperature and transpiration to the availability of water in the soil. This means that the summer temperatures and summer quantities of precipitation, evenly distributed, are of great importance.

Table 7. Evapotranspiration calculated by means of the water balance equation ( $P = Q + E$ ) for the catchment of Lake 4, mm/year

Hydrologic year	P	Q	E = P - Q
1970/71	1044	718	326
1971/72	1006	674	332
1872/73	862	457	405
1973/74	797	493	304
1974/75	939	632	307

Table 8. As Table 6, but for the catchment of Lake 2

Hydrologic year	P	Q	E = P - Q
1977/78	1209	950	259
1978/79	896	632	264
1979/80	884	533	351
1980/81	688	466	222
1981/82	1035	729	306

The evapotranspiration values were determined by the water balance calculation and are given in Tables 7 and 8. Data procured by calculated differences are encumbered by relatively great uncertainties. It is therefore expected that the evapotranspiration values will vary relatively much. This is partly the case with the present data. The highest value, 405 mm, was noted in the hydrologic year 1972/73 for the catchment of Lake 4 and the lowest value, 222 mm, in the year 1980/81 for the catchment of Lake 2. If these two extreme values are excluded the evapotranspiration in the research area seems to be around 300 mm per year.

An attempt to explain the variations in the calculated evapotranspiration data in relation to the summer temperatures and quantities of precipitation has not been successful. For example the two extremes mentioned occurred in years with no special meteorological conditions recorded.

*Potential evaporation measurements* have been carried out in the two summers 1978 and 1979 with the following results in mm per month:

Year	Month					Sum
	May	June	July	August	September	
1978	71	99	66	53	18	307
1979	59	84	57	48	25	273



These values are of an expected magnitude, compared with similar measurements (Myhr 1986, Grøterud 1986) and taking into consideration the height above sea level.

Generally, it seems that the potential evapotranspiration is somewhat higher than the potential evaporation which again is somewhat higher than the lake evaporation (Otne & Ræstad 1978). On the other hand, the actual or real evapotranspiration is somewhat lower than the potential evapotranspiration due to lack of water in the soil.

On the basis of all the above mentioned facts it was decided to choose, *for the sake of simplicity*, 300 mm per year as a *standard value for the evapotranspiration and evaporation from the lakes* in the research area. As a consequence, three *standard values for the precipitation* are given, namely  $625 + 300 = 925$  mm/year for Lake 4 and the neighbouring lakes,  $650 + 300 = 950$  mm/year for Lake 2 and the neighbouring lakes and  $600 + 300 = 900$  mm/year for Lake 13. The reasonableness of these standard values could be checked roughly by calculating the evapotranspiration's increase on the chloride concentration (chloride is considered as a conservative parameter) of the water in the lakes' catchments. The following calculation can be made:

$$10 \times 925 = CI \times 625$$

$$CI = 9250/625 = \text{ca. } 15 \mu\text{eq/l}$$

10 = chloride concentration in the precipitation,  $\mu\text{eq/l}$  (see Table 3), 925 = precipitation quantity, mm/year, CI = chloride concentration in the runoff (lake water),  $\mu\text{eq/l}$ , 625 = runoff value, mm/year. By comparing the value of CI with the chloride values of the lakes presented in the Table 4, the standard hydrological values decided above seem probable.

#### **4. Water balance and hydraulic retention time and loading**

The water budgets and hydraulic retention time and loading of the lakes on basis of the standard hydrologic values described above are given in Table 9. The data show relatively great differences, with hydraulic retention time of 0.2-2.5 years and hydraulic loading of 1.5 - 15.5 m/year.

Table 9. Water budgets and hydraulic retention time and loading of the lakes calculated on basis of the standard hydrologic values described in the text.

Name	No	Outflow from the lake, $Q_0$ $m^3$	Precipitation on the lake surface, $P$ , $m^3$	Evaporation from the lake surface $E$ , $m^3$	Inflow to the lake, $Q_1 = Q_0 \cdot P + E$ , $m^3$	Hydraulic retention time $T_w = V/Q_0$ , year	Hydraulic loading $Z/T_w$ , $m/year$
Store utg.tj.	1	72719	21375	6750	58094	1.1	3.2
Lille utg.tj.	2	120413	7363	1628	114678	0.3	15.5
Sandtj.	3	188663	104738	33075	117000	1.8	1.7
Sandtj.	4	98125	60125	19500	57500	1.4	1.5
Gudbrandstj.	5	256916	81516	26438	201838	2.5	2.9
Lårvika	6	397188	69838	22650	350000	1.1	5.2
Sandvika	7	95625	25322	8213	78516	2.5	3.5
Gammledammen	8	436719	33416	10838	414141	0.6	12.2
Breilivann	9	879450	298300	94200	675350	1.2	2.8
Svarttj.	10	662032	98860	32063	595234	2.3	6.2
Andtj.	11	106113	11875	3750	97988	0.2	8.4
Hvals-Broktj.	12	93437	37578	12188	68047	2.3	2.3
Abbortj.	13	668400	81000	27000	614400	1.2	7.4
Ventj.	14	106563	28444	9225	87344	1.5	3.5
Pytt	15	4712	1021	323	4014	0.3	4.4

## V. FIELD AND LABORATORY EXPERIMENTS

### 1. Addition of NaOH and ice to minicatchments

The snow in minicatchment 1 was neutralized with NaOH before the snowmelt in 1978. Concentrations of important parameters were measured in water every tenth day until all the snow had melted. The results have been compared to those obtained for the reference catchment in the neighbourhood (Fig. 28). The parameter values in the minicatchment follow roughly the values in the reference catchment, except the Na values, which are clearly higher in the minicatchment in the first part of the snowmelt. This is in accordance with Rosenqvist et al. (1980) and Seip et al. (1980). Na-ions have been exchanged for hydronium ions.

The snow in minicatchment 2 was replaced by ion-poor clear ice (Grøterud 1978) in the same period as for the neutralization of minicatchment 1. The same parameters were measured. The ion concentrations show, as expected, lower values than in the reference catchment, but the hydronium and sulphate concentrations are still surprisingly high.

Some ions are supplied by the precipitation (about 60 mm during the snowmelt period) and the rest are leached (desorption included) from the ground. The latter phenomenon applies especially to the hydronium and sulphate ions. Singh (1984) has described desorption of sulphate from acid forest soils under varying conditions and his results indicate that parts of the leached sulphate could be explained by desorption.

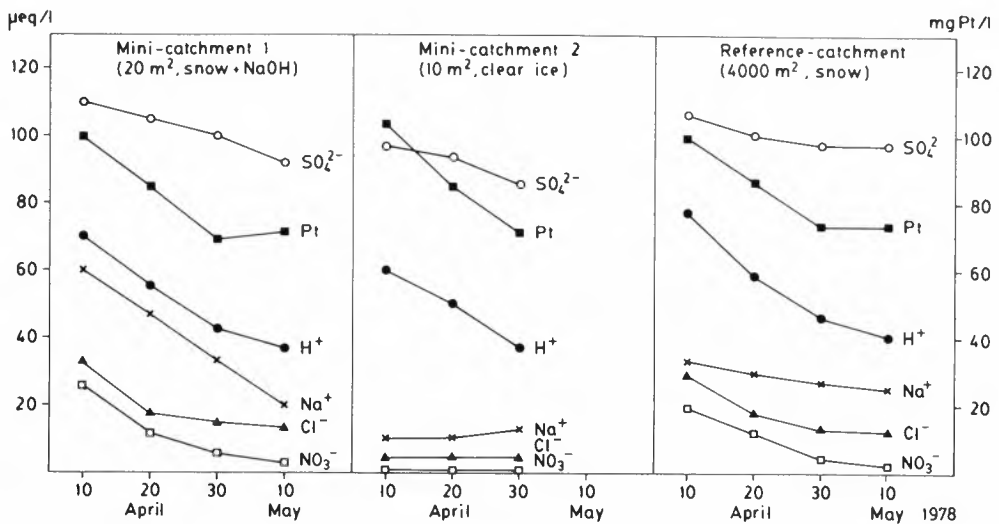

Fig. 28. Concentration of important parameters measured every tenth day until all the snow had melted in two minicatchments and a reference catchment. The minicatchments were added NaOH to the snow (No. 1) and replaced the snow with ion-poor clear ice (No. 2).

## 2. Laboratory lysimeter experiments

Lysimeter experiments with topsoil give additional evidence (besides micro-drainage and runoff from small catchments) that the terrestrial ecosystem is a great source of hydronium ions. The results given in Table 10 are from one of the lysimeter experiments on topsoil sampled just after the spring flood. Similar results have been previously described (Grøterud 1981) and are assumed to give a representative picture of the experiments performed. The percolated lysimeter water seem to contain surprisingly high concentrations of hydronium in spite of the low concentrations of cations in the input water. Unfortunately no anions of strong acids (sulphate) were analysed, but it is supposed that the hydronium ions in question are contributed by sulphuric acid and humic acids leached from the soil. The leaching process here may be comparable with that described for the field experiment with addition of ice to a minicatchment.

Calculations on the basis of data from Table 10 give the percolating water (2376 ml) a weighted mean value of 149  $\mu\text{eq H}^+/\text{l}$ . This means 720 mm water with pH 3.83. Natural precipitation in the area is about 950 mm yearly («standard values», see Chapter IV) with pH about 4.4 (see Chapter III), and on this basis the topsoil seems to contribute to the drainage water roughly four times the amount of hydronium as the precipitation. This is in agreement with the runoff measurements in the small catchments carried out during the snowmelt period (see Chapter III).

Table 10. Results from a lysimeter experiment at room temperature with top podzol soil (humus layer) sampled 18.5.78 Soil surface; 33 cm<sup>2</sup>. Soil thickness: 10 cm. Simulated rain: Distilled water. The soil is stored at 4 °C during resting periods

Date	Simulated precipitation			pH	Hydronium $\mu\text{eq}$
	mm	min.	mm/min.		
<u>1978</u>					
22.5	30	10	3.0	3.85	14
6.6	30	10	3.0	3.85	14
7.6	50	30	1.7	3.90	21
15.6	100	50	2.0	3.80	52
22.6	25	10	2.5	3.65	19
26.6	45	30	1.5	3.70	30
27.6	100	50	2.0	3.80	52
4.7	60	30	2.0	3.75	35
25.7	100	50	2.0	3.85	47
28.7	50	50	1.0	3.85	24
10.8	30	10	3.0	3.90	12
20.8	100	50	2.0	4.00	33
Sum	<u>720</u>				<u>353</u>

### 3. Laboratory experiments with undisturbed water-sediment cores

Many experiments with undisturbed water-sediment cores from the lakes have been performed. Some representative results from Lake 1 are shown in this paper in Figs. 29, 30 and 31. Each point in the diagrams is a mean value from four parallel experiments, two from maximum and two from middle depth. The lines (curves) through the points are therefore smooth and give a reliable impression of the relation between pH and time.

The experiments with excessive loading of acid, i.e. replacement of the natural water with melted snow, with  $H_2SO_4$  added to pH 3.4, are given in Fig. 29. It seems obvious that the pH change or rate of hydronium consumption was greatest in the beginning when the concentration was highest (an exponential pH increase). The essential consumption takes place in a relatively short time. The final level (about pH 4.8) could either be due to buffering or an exhausted buffering or neutralizing capacity (Grøterud & Hongve 1980, Grøterud 1981). The hydronium consumption by the sediments is assumed to be caused mainly by ion exchange and adsorption of the major cations, adsorption and reduction of sulphate, release of ammonia by decomposition of organic matter and neutralization of hydronium by aluminium, iron and manganese hydroxides (Hongve 1978, Grøterud & Hongve 1980, Grøterud 1981). Indications of this are obtained by analyses of the components in the water after the experiment. The analyses show an increase of the major cations, ammonia (especially if water boatmen were used for turbulence; see the laboratory experiments with water boatmen), aluminium, iron and manganese and a reduction of the sulphate.

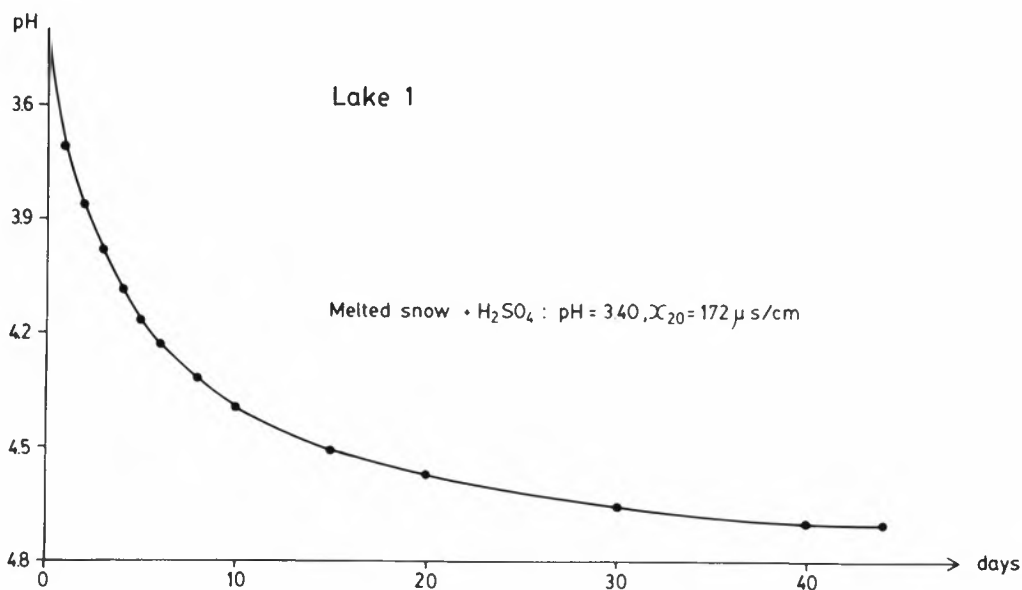

Fig. 29. pH increase in water which has been acidified to pH 3.4 and in steady contact with the sediment of Lake 1. The natural water has been replaced by melted snow, added  $H_2SO_4$ .

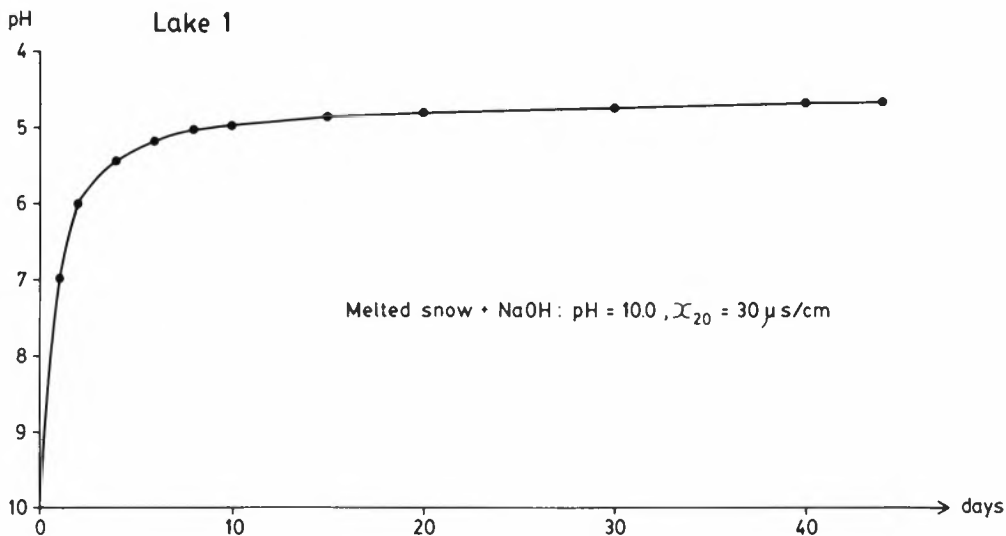

Fig. 30. pH decrease in water which has been alkalinized to pH 10.0 and in steady contact with the sediment of Lake 1. The natural water has been replaced by melted snow, added NaOH.

The results obtained by introducing melted snow added NaOH or distilled water instead of the natural water above the sediment cores (Figs. 30 and 31) indicate that together with the first mentioned experiments the final pH level is a buffering level. The lines through the points seem to move towards a pH level at 4.8 - 4.6. (Figs. 29, 30 and 31).

#### 4. Storing of stones in distilled water and storing of percolation water

Simple experiments with distilled water and stones, taken from brooks, the littoral zone in lakes and fracture zones in rocks with temporary stagnant water, were carried out to throw light on possible acid-producing or -consuming processes in natural fresh waters. Surprisingly, the experiments showed acid production with visible growth of periphytic algae only after some months.

Results from the experiments performed with a small littoral stone are shown in Tables 11 and 12. In addition to hydronium ions there are values of conductivity and colour (as mg Pt/l) which show leaching of ions and humic matter from the stone. At the end of the experimental run the colour is dominated by the developed algae (green). Unfortunately no other parameters than those given were analysed. But it is supposed that sulphuric and humic acids are involved in the hydronium ion production. This production is not easy to explain on this slight basis, and the results can only be regarded as descriptive. Neither can the acid production be transferred to natural conditions without strong reservations.

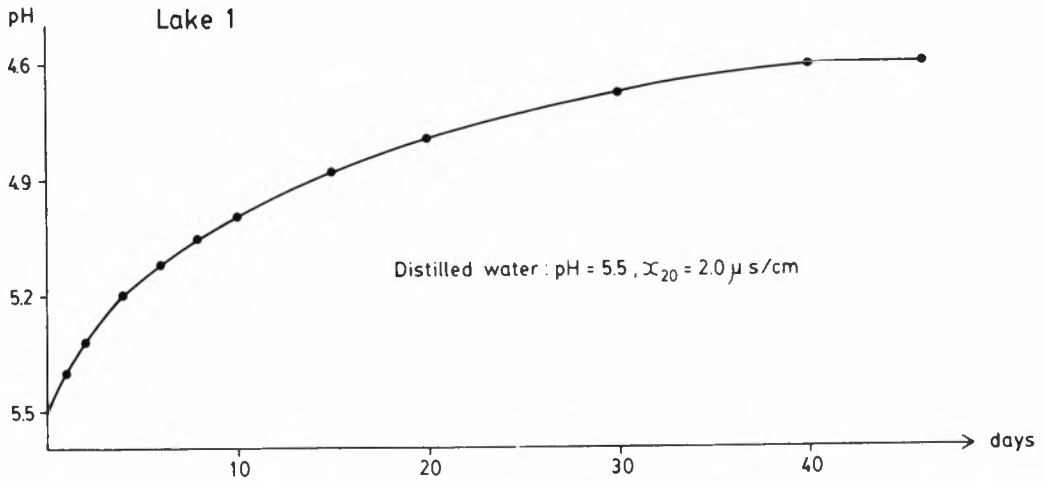

Fig. 31. As Fig 30, but with distilled water of pH 5.5.

Table 11. Results from a simple experiment with 0,5 l distilled water and a small stone ( Biotite granite with a size of about  $100 \text{ cm}^3$  ) taken from the littoral zone in Lake 1. At the end of the experiment a great concentration of small round green algae in gelatinous envelopes, possibly cysts of Tetrasporales, was observed in the water which had been coloured green. The temp. was about  $20^\circ \text{C}$  during the experiment

Date	pH	$K_{20}$	Colour, mg Pt/l
23.5-1979	5,60	2,0	0
25.5	5,00	8,8	10
11.6	5,80	20,2	-
18.7	5,80	30,1	65
3.9	4,74	50,0	-
26.9	5,01	48,0	50
22.10	4,20	80,0	-
26.11	4,00	-	-
26.2-1980	3,36	174	-
25.4	3,36	162	-

Similar storing experiments with water which has previously percolated through top soils in a lysimeter arrangement have been done. A typical example from these experiments is given in Table 13. The high concentration of phosphorus is assumed to explain the heavy growth of algae (green colour). The high production of hydronium ions may be connected to the algal growth. But also in this case the basis is too slight to offer an explanation, and the main purpose of the report is to describe an interesting discovery.

Table 12. Results from the second experiment with the same stone as referred to in Table 11. At the end of the experiment a great concentration of diatoms, probably *Pinnularia interrupta* f. *minutissima* Hustedt, was observed in the water which had been coloured green. The temp. was about 20 °C during the experiment

Date	pH	K <sub>20</sub>	Colour, mg Pt/l
25.4-1980	5,60	2,0	0
29.4	5,50	3,0	0
28.5	4,47	20,0	5
7.7	4,20	26,9	-

Table 13. Storing experiment with water which has percolated through a raw-humus layer in a lysimeter arrangement. Small particles were present in the water. The raw-humus was taken from the soil in the catchment of Lake 1. At the end of the experiment the percolated water was coloured green by algae. Total P in the water was 137 µg/l. The temp. during the storing was about 20 °C

Date	pH	K <sub>20</sub>	Colour, mg Pt/l
1.10-1979	3,75	115	400
1.6-1980	3,30	285	-

Table 14. Simple experiments with water boatmen (*Corixidae*) in polyethylene bottles. Four water boatmen were put into 400 ml distilled and humic waters for some days and the changes in some water parameters were recorded

Water types	Numer of days	pH	K <sub>20</sub> , µs/cm	Colour, mg Pt/l
Distilled water	0	5,55	1,95	0
	1	5,90	2,70	0
	2	6,10	3,80	0
Humic water 1	0	4,12	36,5	25
	3	5,00	26,0	15
Humic water 2	0	4,22	29,7	60
	1	4,30	27,8	60
	3	4,55	23,0	55



### 5. Water boatmen (*Corixidae*) in the laboratory

When using water boatmen to create turbulence in experiments with water sediment-cores, it seems obvious that the water quality also will be somewhat modified by the presence of the organisms. To test this, simple experiments with water boatmen were performed. Some representative results are given in Table 14. Hydronium consumption and colour reduction seem to occur in water with water boatmen. In the humic water the humic matter (Fe, Mn) was precipitated and this could explain the colour reduction. The mechanism behind the precipitation is not known, but there are two possibilities: 1. The water boatmen consume the humic particles and precipitate them as excrements. 2. The excrements from the water boatmen act as flocculation agents, thus precipitating the humus particles.

Unfortunately only ammonia was analysed in addition to the parameters shown in Table 14. Therefore it is impossible to draw any exact conclusion from these findings. Even the ammonia analyses were done too sporadically, i.e. on some waters at the beginning and end of the experiments only. These analyses, however, indicate ammonia production by the water boatmen, and that this production can explain at least a part (breakdown of humic acids may be another part) of the hydronium consumption found. Very roughly the results indicate that one water boatman will consume about  $1.5 \mu\text{eq H}^+$ /day at  $15^\circ\text{C}$  in acid humic water. To elucidate the magnitude of this consumption, 20-30 water boatmen per  $\text{m}^3$  (a density which may occur in acid humic lakes without fish) will consume about  $15 \mu\text{eq H}^+$ /l year, corresponding to a pH increase from 4.4 to 4.6.

### 6. Lake fertilizing

Lake 15 was chosen for investigating the effect on the acidity of increased primary production by adding phosphorus (which was supposed to be a limiting factor). Increased acidity was recorded as a short and decreased acidity as a long term effect (Grøterud 1982a, 1982b). The water quality development after the fertilizing is shown by three parameters in Table 15. The water and plankton algae samples were taken from 1 m depth (max. depth is 2.0 m) and the attached algae were scraped from birch boughs hanging down into the water.

The short term effect is seen about one month after the addition of phosphorus by decreased pH, increased concentration of sulphate and reduced humic colour. From measurements in the preceding years a colour reduction during summer was expected, but not as much as shown in this experiment (the min. value previously recorded was  $15 \text{ mg Pt/l}$ ). On the other hand, the increased concentrations of hydronium and sulphate are rather unexpected, since concentrations of these ions in all previous years have clearly decreased during the summer (see Chapter VI). An explanation of this phenomenon is not easy, but there are reasons to believe that some sulphuric acid has been produced (Grøterud 1982b). This production may have been caused by oxidation of sulphur components in the sediments, accelerated by the oxygen production provided by the algal growth. In the autumn the algal matter is broken down in the sediments, consuming the oxygen and thus reducing the redox potential below the limit necessary for reducing sulphate. This may be the reason for the values recorded 18th September, even if it is somewhat difficult to understand such a low  $E_h$  in this shallow lake in the autumn. One point in this connection is that the lake is relatively efficient protected against wind influence. Later in the autumn (27th October) a heavy runoff from the catchment is the reason for the strongly coloured acid water.

Regarding the relatively strong colour reduction recorded in the summer, in relation to previous summers, there are reasons to believe that the decreased pH (Ohle 1940) and the increased growth of algae (measured as an increase of chlorophyll a from <2 to 3 µg/l, see Fig. 123) are of importance. The growth of algae (or the addition of phosphorus) may accelerate the removal of the humic substances (Fe, Mn). The mechanism is not known, but a couple of possibilities can be put forward. 1. The fertilization and subsequent increased algae production activate bacterial decomposition of the humic matter. 2. The algal growth accelerates precipitation of the humic particles by metabolic products (O<sub>2</sub>, organic compounds).

The long term effect (one year or more) has already been indicated by the measurements September 18th (Table 15). Water analyses during the winter, spring and summer of 1983 bear witness to an average increase in pH (about 0.3 units), decrease in sulphate (about 10 µeq/l) and nitrate (about 2 µeq/l) compared with previous years. The water colour also seems to have decreased, but the change is possibly too small to draw any conclusions. The long term effect seems to continue during the winter, spring and early summer of 1984, but then decreases. After this time the lake was limed and the final fertilizing effect could therefore not be exactly determined.

Table 15. Results from a fertilizing experiment in Lake 15. The P-concentration was increased with 40 µg/l by adding H<sub>3</sub>PO<sub>4</sub> 11.6.1982. About one month later a great increase of algae was recorded. The most dominant species were *Mougeotia* (attached algae) and *Dinobryon* (plankton algae)

Date	pH	SO <sub>4</sub> , µeq/l	Colour, mg Pt/l
11.6-1982	4,30	67	30
25.6	4,40	75	20
10.7	4,50	88	15
25.7	4,36	92	10
7.8	4,34	104	7,5
21.8	4,34	92	10
18.9	4,60	83	12,5
27.10	4,17	121	55

## VI. LAKE WATER CHEMISTRY

The lake water chemistry has already been treated very roughly in connection with the description of the water quality and lake ecology in the research area (see chapter III). A more detailed study is given here.

The volume-weighted mean values of important chemical parameters in the outlet of the lakes during three years are given in Table 16. Lake 13 deviated as expected from the other lakes by higher pH, higher concentration of sulphate, calcium, magnesium and reactive silicate and lower concentration of aluminium (except Lake 4). The values measured in the outlet are not completely representative for the values in the lake basin due to short cut flows, especially in the flood periods. But by using the volume-weighted mean values over a three-year period the discrepancies are assumed to be relatively small.

The relationships between the eleven important parameters given in Table 16 are elucidated by the Pearson correlation matrix presented in Table 17. Lake 13 is rather unlike the other lakes in many respects and is therefore kept apart. pH is assumed to be mainly influenced by  $\text{SO}_4$ , Ca, Pt (colour), Fe and Al. A multiple stepwise regression analysis gave:

$$\begin{aligned} \text{pH} &= 6.180 - 0.017 \text{SO}_4 + 0.007 \text{Ca} \\ r^2 &= 0.895, p < 0.001, n = 14 \end{aligned}$$

The pH variations was best adapted to this regression equation (about 90% is explained). A model also including Pt and Al did not improve significantly the prediction (about 1%). In this connection it is of interest that Henriksen (1982) has described a regression model for lake acidification by means of excess  $\text{SO}_4$  and excess (Ca + Mg).

The variations of Al was by stepwise regression best adapted to:

$$\begin{aligned} \text{Al} &= 5.786 + 1053.593 \text{Fe} \\ r^2 &= 0.820, p < 0.001, n = 14 \end{aligned}$$

But in an acidification context Fe could not directly determine the Al concentrations in the lake waters. A model using pH,  $\text{SO}_4$  and Pt should, however, be of interest. The best adapted regression equation was:

$$\begin{aligned} \text{Al} &= -872.226 + 10.569 \text{SO}_4 \\ r^2 &= 0.736, p < 0.001, n = 14 \end{aligned}$$

If pH and Pt were included, the prediction was improved by only about 2%. The sum of Al and  $\text{H}^+$  has been plotted against  $\text{SO}_4$  in another research work with  $r = 0.93$  (Overrein et al. 1980).

Regarding the correlation coefficient matrix in Table 17, the values are, broadly speaking, in agreement with data from other research (Dickson 1975, Wright & Gjessing 1976, Wright et al. 1977, Wright & Henriksen 1980, Mohn et al. 1980a, b, Brække 1981) although some discrepancies have been stated. This applies especially

Table 16. Volume-weighted mean values of important parameters in the outlet of the lakes during 1st Oct. 1977 - 30th Sept. 1980 (n = 27)

Innsjø	Nr.	pH	Colour mg Pt/l	SO <sub>4</sub> <sup>2-</sup> µeq/l	NO <sub>3</sub> <sup>-</sup> µeq/l	Ca <sup>2+</sup> µeq/l	Mg <sup>2+</sup> µeq/l	Al µg/l	NH <sub>4</sub> <sup>+</sup> µeq/l	Si mg/l	Fe µg/l	Tot. P µg/l
Store utg.tj.	1	4.43	31	110	6	25	25	250	12	0.50	250	11
Lille utg.tj.	2	4.29	51	114	6	26	28	380	4	1.10	360	13
Sandtj.	3	4.60	10	103	7	18	25	150	20	0.40	140	6
Sandtj.	4	4.89	9	93	5	45	45	70	23	0.30	100	8
Gudbrandstj.	5	4.82	5	101	3	55	50	200	14	0.50	190	4
Lårvika	6	4.41	30	111	6	20	50	280	7	0.95	240	10
Sandvika	7	4.38	25	109	5	15	25	280	12	0.90	250	6
Garnledammen	8	4.37	50	118	7	18	12	310	6	1.25	330	13
Breilivann	9	4.54	33	103	6	25	25	280	14	0.85	230	11
Svarttjern	10	4.82	20	103	4	45	47	280	8	1.50	250	4
Andtjern	11	4.33	65	116	6	22	29	400	7	1.30	340	17
Hvals-Broktj.	12	4.52	10	103	5	20	25	280	15	0.50	180	5
Aborttjern	13	7.00	20	128	3	450	55	110	4	2.40	180	8
Venttjern	14	4.62	12	99	6	20	32	190	11	0.45	210	7
Pytt	15	4.41	30	107	5	25	30	250	10	0.70	270	14

Table 17. Pearson matrix of correlation coefficients (r) for the values given in Table 16 except Lake 13 (n = 14)

	pH	Pt	SO <sub>4</sub> <sup>2-</sup>	NO <sub>3</sub>	Ca <sup>2+</sup>	Mg <sup>2+</sup>	Al	NH <sub>4</sub> <sup>+</sup>	Si	Fe	Tot. P	H <sup>+</sup>
pH	1.000											
Pt (colour)	-0.761	1.000										
SO <sub>4</sub> <sup>2-</sup>	-0.862	0.893	1.000									
NO <sub>3</sub>	-0.583	0.472	0.487	1.000								
Ca <sup>2+</sup>	0.789	-0.395	-0.532	-0.779	1.000							
Mg <sup>2+</sup>	0.629	-0.433	-0.526	-0.662	0.721	1.000						
Al	-0.745	0.822	0.858	0.181	-0.373	-0.340	1.000					
NH <sub>4</sub> <sup>+</sup>	0.631	-0.725	-0.766	-0.138	0.258	0.137	-0.850	1.000				
Si	-0.368	0.707	0.674	0.065	-0.084	-0.075	0.775	-0.784	1.000			
Fe	-0.752	0.894	0.881	0.259	-0.328	-0.379	0.905	-0.923	0.774	1.000		
Tot. P	-0.698	0.876	0.703	0.524	-0.383	-0.405	0.552	-0.495	0.368	0.690	1.000	
H <sup>+</sup>	-0.984	0.822	0.876	0.530	-0.698	-0.570	0.776	-0.672	0.434	0.807	0.739	1.000

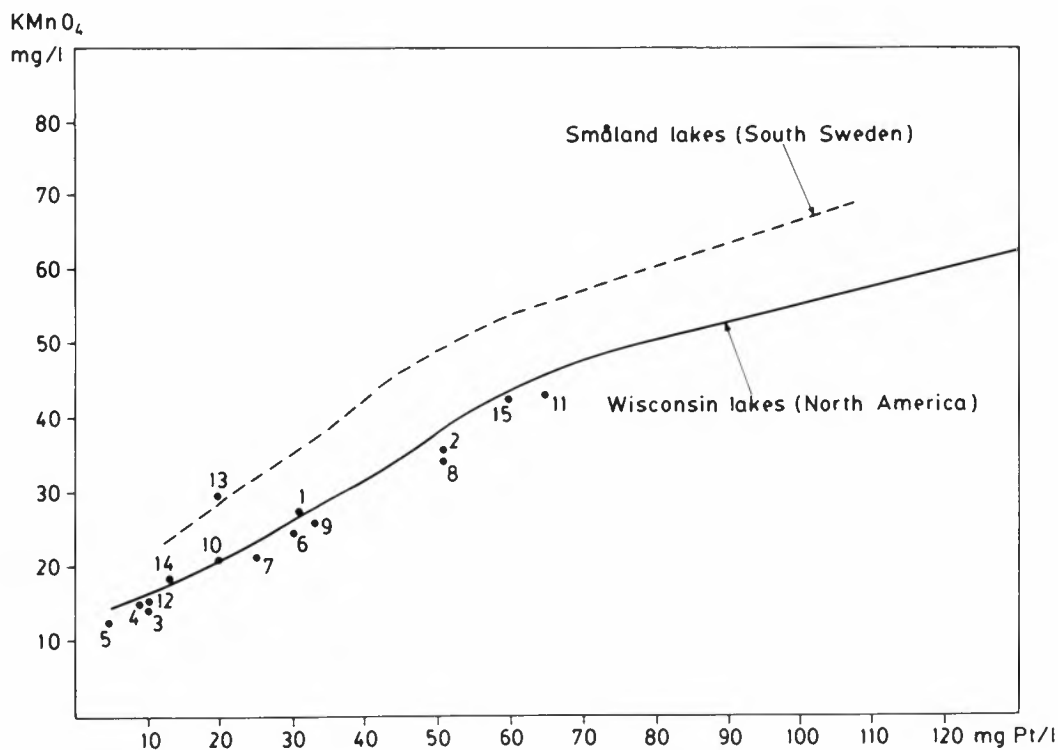

Fig. 32. The relation between  $\text{KMnO}_4$  consumption and water colour (Pt) for the Finnemarka lakes compared with Småland lakes (Thunmark 1937) and Wisconsin lakes (Juday and Birge 1932). The colour values are taken from Table 16 and the  $\text{KMnO}_4$  values are yielded in the same way and time period, but on basis of 12 samples only (one in the spring, summer, autumn and winter during three years).

to the data from Brække (1981) which are analyses of different kinds of terrestrial waters (drainage).

The concentrations of total P in the lakes seem high compared with more productive lowland lakes. This is somewhat complicated to explain. Some hypotheses can be presented. 1. In the lakes with coloured waters the humic substances contribute P, which is also indicated by the correlation coefficient between P and Pt (0.876). 2. Much of the P, measured as volume-weighted mean values in the outlet, is relatively little utilized by the algae because the transport of P through the lake and concentrations in the water masses are greatest in the flood period, which is unfavourable for algal growth (low temperatures). 3. The P in the lake waters is relatively little available to the algae, owing to sorption of P by the Al and Fe complexes (the sorption by the humic complexes is included in point 1). The correlation coefficients between P and Al (0.552) and between P and Fe (0.690) may be an indication of this. 4. Elements other than P or in addition to P could be limiting for algal growth. 5. Some toxic components (Al,  $\text{H}^+$ , humic substances) for the algae may exist in the lake waters.

Table 18. pH and water colour (mg Pt/l) recorded during autumn, winter, spring and summer 1977/78 in Lake 1

Depth m	Date	2.10.77		5.1.78		29.4.78		20.7.78	
		pH	Pt	pH	Pt	pH	Pt	pH	Pt
0.5		4.40	40	4.50	30	3.85	70	4.75	15
2		4.40	40	4.50	30	4.20	60	4.65	20
5		4.45	35	4.40	35	4.40	40	4.60	30
8		4.50	35	4.45	40	4.60	45	4.60	35
9		4.55	45	4.70	45	5.50	55	4.85	40

Table 19. The same as in Table 18 for Lake 3

Depth m	Date	2.10.77		5.1.78		30.4.78		20.7.78	
		pH	Pt	pH	Pt	pH	Pt	pH	Pt
0.5		4.55	10	4.65	5	4.00	10	4.80	< 5
2		4.58	10	4.65	5	4.30	5	4.70	< 5
6		4.60	5	4.55	5	4.40	5	4.60	5
8		4.60	5	4.50	10	4.90	10	4.80	5
8.5		4.65	10	4.60	10	5.20	15	5.00	10

The organic matter in the lakes is of two main types: humic substances derived from the drainage area (allochthonous matter) and algal biomass, macrophytes and animals produced in the lake waters (autochthonous matter). The concentration of humic matter is often measured as water colour (mg Pt/l) and the concentration of organic matter is often determined as  $\text{KMnO}_4$  consumption. Both parameters give indirect values and consequently are of uncertain validity. Rodhe (1951-52) has presented a diagram which shows the relation between  $\text{KMnO}_4$  consumption and colour as mg Pt/l on data from Wisconsin lakes (Juday & Birge 1932) and Småland lakes (Thunmark 1937). The Finnemarka lakes are plotted in this diagram, and they seem to have about the same relation as the Wisconsin lakes (Fig. 32). An exception is Lake 13, which seems to fit better with the data from Småland lakes. It is difficult to explain the difference between these lake groups, but it is supposed to be partly connected to the portion of autochthonous matter of the total amount of organic matter in the lake waters. The lakes with the highest  $\text{KMnO}_4$ /Pt ratio (Småland lakes and Lake 13) are assumed to be the most productive. Another view is that these lakes contain allochthonous matter with another optical properties and/or more easy decomposable

by  $\text{KMnO}_4$  than the Wisconsin and Finnemarka lakes (except Lake 13). There are also uncertainties connected to the acidity and the concentration of Fe and Mn of the lakes. The Finnemarka lakes are acid and have a relatively high concentration of Fe and Mn (except Lake 13). Finally, the different methods used for determining the  $\text{KMnO}_4$  consumption must also be mentioned regarding the uncertainties.

If the lakes had acted as reactors (i.e. with water constantly mixed), the data given in Table 16 would have been entirely representative for the lake water chemistry. But because of the short cuts of the flow-through, as already pointed out, and lake stratification, this is not true. The acidity and humic colour have been recorded once every season in all lakes for at least three years. A general picture of these recordings is elucidated by values from two representative lakes, one humic and one clear water lake (the latter is here defined as having water with mean colour  $< 15$  mg Pt/l) during 1977/78. These values are given in Tables 18 and 19. In the autumn, pH increases from the surface to the bottom due to heavy input of acid water from the terrestrial catchment and the atmosphere and a buffering effect from the sediments. The water colour decreases from the surface downwards, with an increase just above the sediment surface. The decrease is caused by minor influx of coloured drainage which dominates the uppermost water layers and the increase is connected to the sediments, either as leakage from below or accumulation from above of humic substances. In the winter, pH first decreases downwards and then increases towards the sediment surface, i.e. a dichotomous pH stratification (cf. Yoshimura 1932). The water colour increases from the lake surface to the bottom. This is probably due to precipitation and transportation of the humic substances into deeper water. The ice sheet will prevent the wind-induced currents and turbulence, thus providing good conditions for sedimentation of small particles (humic colloids). The very low flow rate in the winter also favours this process. In the spring, just before the ice break-up, the acidity shows its highest yearly value in the water just beneath the ice sheet (see also Grøterud 1972b, c, 1973). This phenomenon is related to the influx of acid meltwater, which also seems obvious considering the water colour. The latter is very strong in the uppermost water layers, especially in the lakes most influenced by drainage (high ratio  $A_d/A_o$ , see Table 2). Just below the meltwater-affected strata the colour is weakest, then increases again towards the bottom. This is a dichotomous colour stratification. In the summer the acidity shows the same dichotomous pH stratification as described for the winter situation, and the water colour increases from the surface to the bottom, also as described for the winter.

Due to lack of systematic measurements of other necessary parameters an explanation of the above-mentioned recordings will be somewhat speculative. But some indications will nonetheless be given. The pH values in the top water layers may be connected to the water colour. Strong water colour may give low pH, and some sort of acids (sulphuric and humic acids) may therefore be related to the concentration of humic matter. The water quality is much like bog waters (see Gorham et. al. 1985). In the meltwater period, nitric acid is in addition supposed to be responsible for parts of the acidity recorded just below the ice cover (Grøterud 1972b). The relatively high pH values just above the sediment surfaces are recorded along with relatively strong water colour. This phenomenon reflects the sediment effect on the bottom waters and that decomposition, by lowering the redox potential, reduces the acid components (sulphate). In addition to humic matter, Fe and Mn may have been involved in the Pt colour values recorded, especially in the bottom waters of the lakes. All the processes described in Chapter V, Section 3 may be in effect.

Changes in the water chemistry of the lakes during the research period seem to be moderate. The most important are pH and oxygen in the bottom waters and mean pH and water colour of the whole water masses of some lakes. In Lakes 3, 5, 12 and 14 the oxygen concentrations seem to have increased and pH decreased in the last meter above the sediment surfaces. In the first three years of the research (1970, -71 and -72) the bottom water in Lake 5 was anaerobic by the end of the winter. In 1978, -79 and -80 this water contained about 1 ml O<sub>2</sub>/l at the same time of year. The three other lakes mentioned seem to have increased the oxygen concentration from about 0.5 to 1.5 ml/l. The pH decrease in the bottom water has roughly been 0.5 units in Lakes 5 and 12 and 0.2 in Lakes 3 and 14. Measurements made in situ (see Grøterud 1971b) and in sediment cores bear witness of a moderate pH decrease (about 0.2) in the surface of the sediments in Lakes 3, 5, 8, 12 and 14 during 1970-82. But due to different methods (in situ measurements 1971b and sediment cores 1982) these findings have to be used with caution. Lakes 3, 5, 12 and 14 seem to have established a lower pH (0.1-0.4) in the water body at the end of the research period. The water colour seems to have increased in Lakes 3, 4, 5, 7, 12 and 14 by 5-10 mg Pt/l. All these lakes are clear water lakes (previously defined as lake water < 15 mg Pt/l). These changes in water chemistry are probably involved in the acidification development in the area and are later treated more closely in connection with the discussion of the acidification dynamics.



## VII. LAKE RETENTION OF SUBSTANCES

Lakes can act as reservoirs for substances in the runoff waters and can consequently accumulate, consume or produce substances in the waters. Information about these phenomena may be obtained by determining the lake retention of different substances.

The determination of this retention presupposes satisfactory measurements of the quantity and quality of the water input and output to the lakes. The quantity of water is considered to have been satisfactorily measured and calculated (see Table 9). The quality of the input water, however, is featured by some ground water inflow to the lakes. The seepage water has been investigated relatively thoroughly, as mentioned in chapter II, by taking small water samples with a pipette just near to the shore of the lakes. The ground water flowing sublacustrine into the lakes has not been analysed. This quantity of water is supposed to be small and has also been impossible to sample.

### 1. Input - output measurements and calculations

The lake retention ( $R_x$ ) of the component x in the lakes was calculated by the formula:

$$R_x = \frac{Q_I C_I - Q_O C_O + PC_p}{A_0}$$

- where
- $Q_I$  = inflow to the lake
  - $Q_O$  = outflow of the lake
  - $P$  = precipitation on the lake surface
  - $C_I$  = volume-weighted mean concentration of the component x in the inflow
  - $C_O$  = volume-weighted mean concentration of the component x in the outflow
  - $C_p$  = volume-weighted mean concentration of the component x in the precipitation
  - $A_0$  = surface area of the lake

This formula do not take into consideration the mentioned uncertainty of seepage water and sublacustrine ground water supply to the lakes. The  $C_I$  values (and hence the  $R_x$  values) will probably be somewhat too high or too low, depending upon which component is calculated. E.g. hydronium is supposed to be too high and calcium too low (the hydronium and calcium concentrations are relatively low and high respectively in the ground water). However, the calculated  $R_x$  values in this research are, in spite of the indicated uncertainties, considered to be usable for throwing some light on important relationships and showing orders of magnitude.

The values of  $Q_I$ ,  $Q_O$  and  $P$  are given in Table 9. The volume-weighted mean concentrations ( $C_I$ ,  $C_O$ ,  $C_p$ ) were determined by the general formula:

$$C = \frac{\sum_{i=1}^n C_i \cdot q_i}{\sum_{i=1}^n q_i}$$

where  $C_i$  = concentration of water sample  $i$   
 $q_i$  = water flow at water sample  $i$

By volume-weighting the concentration in the inflow ( $C_I$ ) to some lakes the outlet flow was used for practical reasons (see Chapter II).

Some values of  $C_p$  and  $C_O$  are shown in Tables 3 and 16 respectively. The volume-weighted mean concentrations of Na and K in both the inflow and outflow of the lakes were determined by means of 12 measurements in the same samples as used for the  $KMnO_4$  determinations (see Fig. 32). The other values were determined by 27 measurements (see Table 16). The concentrations of humic matter (Pt colour), Fe, Al and Si (reactive silicate) in the precipitation were assumed to be zero in these retention calculations, due to lack of measurements and presumably relatively small values. Some sporadic analyses have supported this.

*a) Substance retention in relation to hydraulic loading, substance loading and hydraulic retention time.*

**H y d r o n i u m**

The hydronium retention in the lakes is presented in relation to the hydraulic loading as shown in Fig. 33. The two curves, drawn freehand, describe the hypothetical relations of the plotted values as a basis for discussion. The shape of the curves are chosen on the basis of the lake points and rational thinking. It seems logical to assume that the retention levels off with increasing hydraulic loading.

Regarding Fig. 33, Lakes 4, 5 and 10 seem to belong to another relation type than most of the other lakes. These three lakes seem to have the best ability to resist acidification according to the investigations done during the research period. Lake 4 is the most productive lake (beside Lake 13) and is in addition moderately limed. Lake 5 is relatively deep and has a long hydraulic retention time (2.5 years). Lake 10 is very deep and has the same retention time as Lake 5. Their deep basins, inter alia, may probably also provide a more seemingly  $H^+$  retention than the other lakes due to the unrecorded sublacustrine ground water influxes, which normally is less acid than the surface water. The small amount of lime added to Lake 10 is supposed to be of minor importance in this connection. Lakes 7, 9 and 13 fall outside the two «discussion curves». These lakes deviate somewhat from the others. Lake 7 has its outlet situated near the main influx of water from the terrestrial catchments, so that this water reaches the outlet without the normal mixing with the lake water, especially in the

$H^+$  retention  
meq/m<sup>2</sup> · year

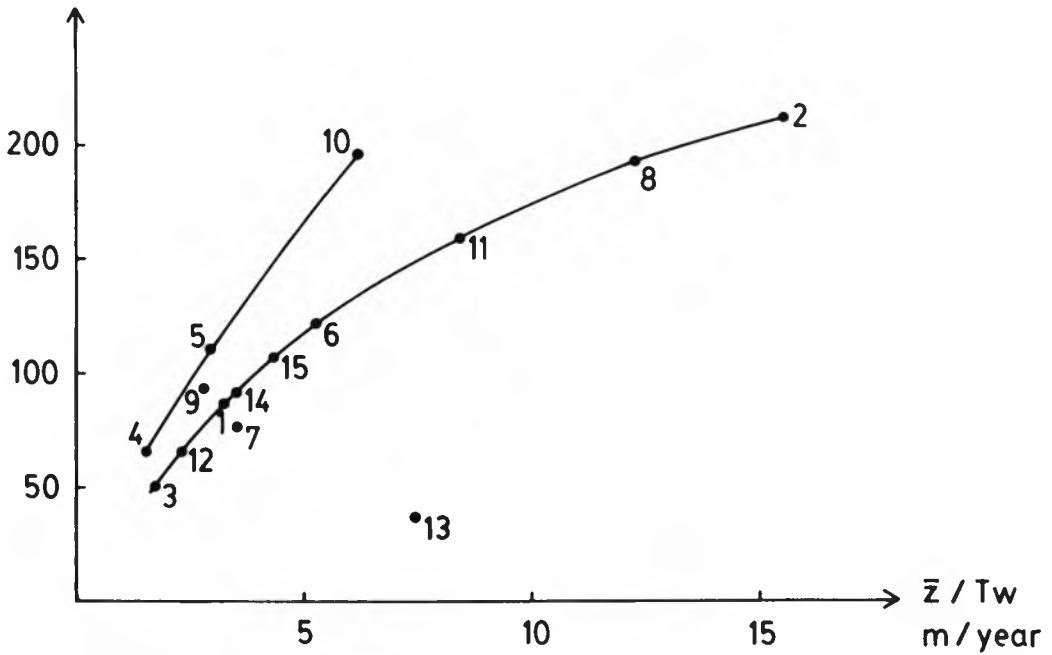

Fig. 33. Hydronium retention as meq/m<sup>2</sup> · year in the lakes in relation to the hydraulic loading. The two curves, drawn freehand, describe the hypothetical relations of the plotted values as a basis for discussion.

$H^+$  retention  
%

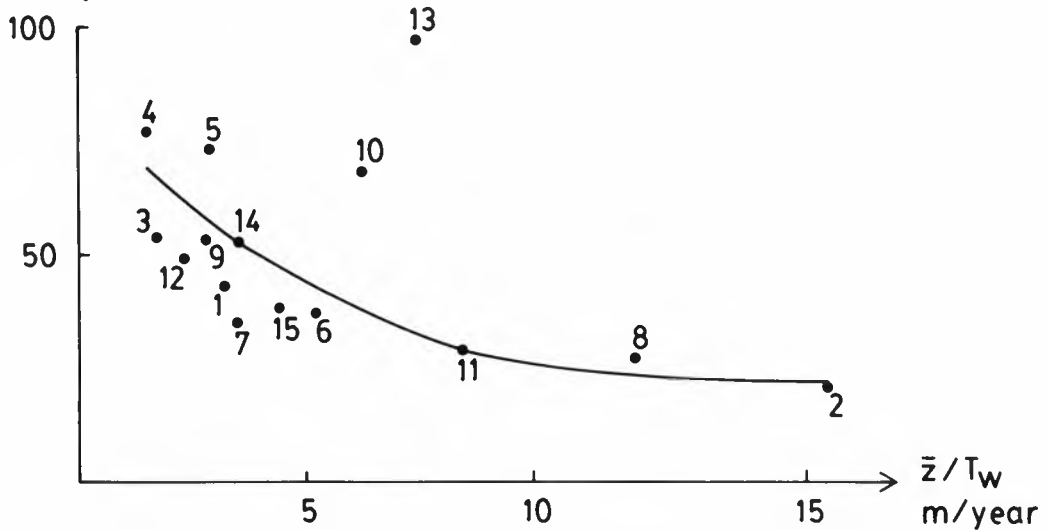

Fig. 34. As Fig. 33, but with retention expressed as % and only one «discussion curve»

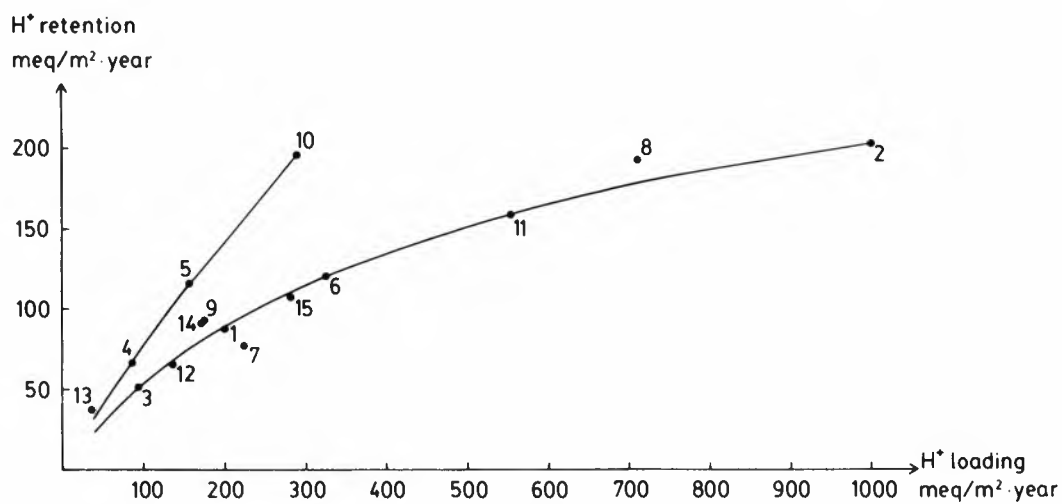

Fig. 35. As Fig. 33, but in relation to hydronium loading.

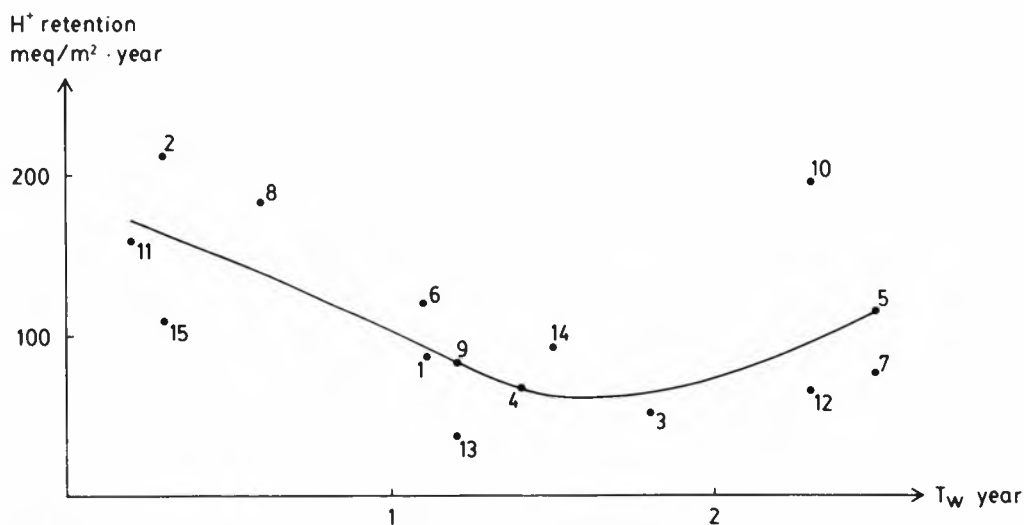

Fig. 36. As Fig. 33, but in relation to hydraulic retention time and only one «discussion curve».

flood periods. The retention of terrestrial components will therefore be less than expected. Lake 9 is regulated, with outflow through a dam gate at about 4 m depth. This seems to favour the hydronium retention by bringing more water into greater depths where the hydronium consumption is greater (Grøterud 1984b). Lake 13 is neutral, with a small hydronium loading and consequently a small hydronium retention.

The retention is also presented as percentage (instead of  $\text{meq/m}^2 \text{ year}$ ) in Fig. 34. The discussion curve is drawn on the same basis and has the same meaning as mentioned above. This diagram throws light on the ability of the lakes to neutralize the input of acids. The best ability seems to be found in the lakes with the lowest hydraulic loading. Lakes 4, 5, 10 and 13 show relatively high values, especially the last one. This is in accordance with what has already been stressed concerning the lakes. The same can be said about Lake 7, but with the opposite trend.

Fig. 35 shows the retention in relation to loading. The two discussion curves are much like those drawn in Fig. 33. A couple of deviations, however, could be mentioned. First, Lake 13 has a rather different position in the two diagrams. Second, the lakes are a little more scattered around the main discussion curve in Fig. 35 than in Fig. 33. This second deviation may indicate a closer connection between hydronium retention and hydraulic loading than between hydronium retention and hydronium loading, due to the fact that the former loading expresses both the loading of hydronium and transport effects down towards the sediment surface (Grøterud & Hongve 1980).

$\text{H}^+$  retention in relation to  $T_w$  is shown in Figs. 36 and 37. The discussion curve in Fig. 36 indicates a minimum or a constant level of about 1.5 years of  $T_w$ . The  $\text{H}^+$  retention is determined by two factors, namely the supply of  $\text{H}^+$  ions and the time these ions are kept in the lakes. These two factors, roughly speaking, act inversely, and their sum is indicated by the discussion curve in Fig. 36. Of the lakes mentioned with distinctive character (Lakes 4, 5, 7, 9, 10 and 13, which will be denoted «deviation lakes» in the subsequent text), Lakes 7, 10 and 13 are found relatively far from this discussion curve. Lake 10 above and Lakes 7 and 13 below must be considered as expected. When expressing the  $\text{H}^+$  retention as percentage, the increasing retention ability with increasing  $T_w$  is indicated as shown in Fig. 37. Three of the deviation lakes are relatively far from the discussion curve, with Lakes 4 and 13 above and Lake 7 below the curve as expected. The  $\text{H}^+$  retention seems to level off at 60-70 % with the increase of  $T_w$ . This suggests that the lakes'  $\text{H}^+$  retentions may have been greater previously as indicated by the  $\text{H}^+$  budget for a lake in Canada (Schindler et al. 1976). This lake, which lies in Precambrian rock, is nearly acidified and has shown  $\text{H}^+$  retention of 95-97 %. It could also be mentioned that Lake Langtjern in Norway has shown a  $\text{H}^+$  retention of 36 % (Henriksen and Wright 1977), which is high in relation to the comparable lakes in Finnemarka (with the same  $T_w$ , which is about 0.2 years for Langtjern). Finally, it could be mentioned that the relationship between pH in land runoff and lake water in the Finnemarka lakes is about the same as recorded in the Swedish Lake Gårdsjön (see Hultberg 1985).

### Sulphate

The  $\text{SO}_4$  retention in relation to  $Z/T_w$  is, broadly speaking, similar to the hydronium retention, with the exception of the ratio values, which are lower for  $\text{SO}_4$  (Figs. 38 and 39). The deviation lakes have about the same position relative to the discussion curve as the hydronium ions, except Lake 13, which lies on the opposite side (Fig. 38). This

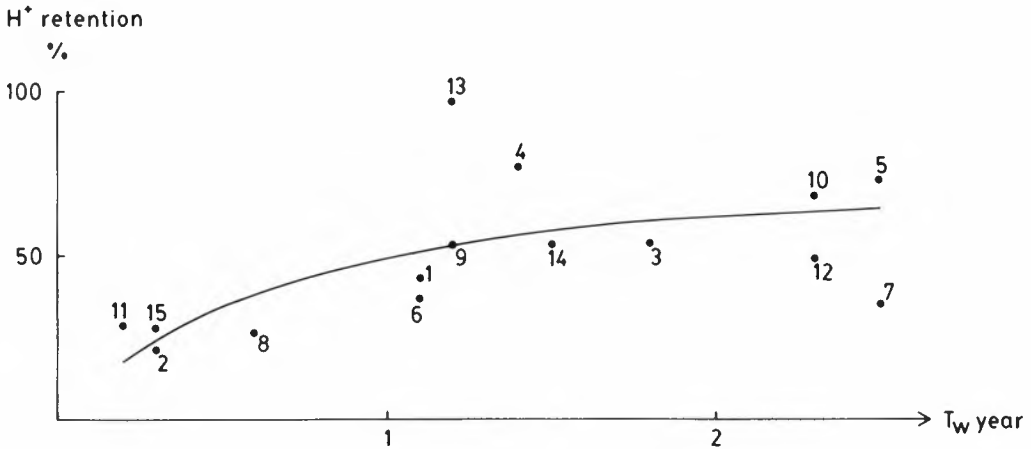

Fig. 37. As Fig. 36, but with retention expressed as %

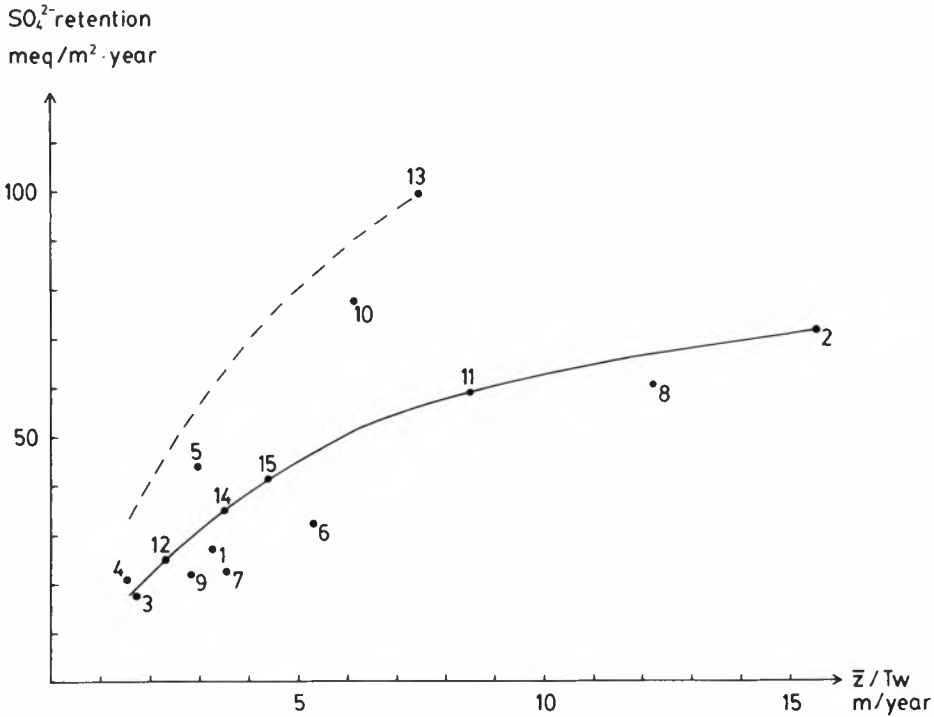

Fig. 38. Sulphate retention as meq/m<sup>2</sup>·year in the lakes in relation to the hydraulic loading. The curve, drawn freehand, describes the hypothetical relation of the plotted values as a basis for discussion. The broken curve indicated values of lakes of the same retention type as Lake 13.

bears witness to the connection between sulphate retention and hydronium retention in the lakes, and that reduced acidity (Lakes 4 and 13), higher productivity (Lakes 4 and 13) and greater depth (Lakes 5 and 10) are favourable regarding the  $\text{SO}_4$  retention.

The broken curve indicates values of lakes of the same retention type as Lake 13 ( $Z/T_w \leq 7.4$  m/year). There is a possibility that some of the other lakes have previously belonged to this type (or similar types).

The  $\text{SO}_4$  retention in Fig. 40 shows that the relation to  $\text{SO}_4$  loading is quite similar to the relation to  $Z/T_w$  (Fig. 38). In Figs. 41 and 42 the  $\text{SO}_4$  retention in relation to  $T_w$  is presented. The discussion curves and the position of lake values are rather similar to the  $\text{H}^+$  retention, except for Lake 13. This is expected and is an additional indication of the close connection between the hydronium and sulphate retentions in the lakes investigated. The percentage retention of sulphate seems to be about 4 - 14.

#### Nitrate

Figs. 43 and 44 show the  $\text{NO}_3$  retention in relation to  $Z/T_w$ . There seems to be a retention maximum around 5 m/year for hydraulic loading. Low hydraulic loading favours  $\text{NO}_3$  retention, as indicated by the discussion curve in Fig. 44. But at loading values less than approximately 5 m/year the retention is more determined by this loading than by long hydraulic retention time, as shown in Figs. 46 and 47. The discussion curve shown in Fig. 45 reflects roughly the same picture

Regarding the deviation lakes, only Lake 13 seems to clearly reflect its character by showing relatively high  $\text{NO}_3$  retention. This indicates that non-acidified lakes have better abilities to retain  $\text{NO}_3$  than acidified ones. The shallow lakes (e.g. Nos. 11 and 15) seem to be more favourable for  $\text{NO}_3$  retention than expected. The sediment effect is assumed to be of importance in this connection.

#### Aluminium

The Al retention seems to follow roughly the same pattern as the hydronium retention. This is shown by Figs. 48, 49, 50, 51 and 52 and indicates a close connection between the two components in question. This is in agreement with the correlation matrix presented in Chapter VI. Lake 11 is an exception and shows a relatively low Al retention. One explanation is that this shallow lake is able to stir up Al components from the sediments, thus preventing them from being permanently accumulated in the lake. The wind effect on the lake is relatively strong. Lake 15 is also shallow, but the wind has little effect in stirring up the water masses and consequently the Al retention does not show a similar trend.

#### Humic substances

The loading and retention of humic substances are determined indirectly by colour measurements as mg Pt/l. This loading and retention are strictly speaking a colour loading and retention and are therefore denoted «humic loading» and «humic retention» in quotation marks. The results are presented in Figs. 53, 54, 55, 56 and 57 and the relations are quite similar to that of aluminium. This indicates a close connection to the aluminium, supported by the correlation matrix given in Chapter VI.

It is necessary to mention that the concentration and amount of humic matter has been expressed by means of Pt colour units in the absence of a better alternative. This

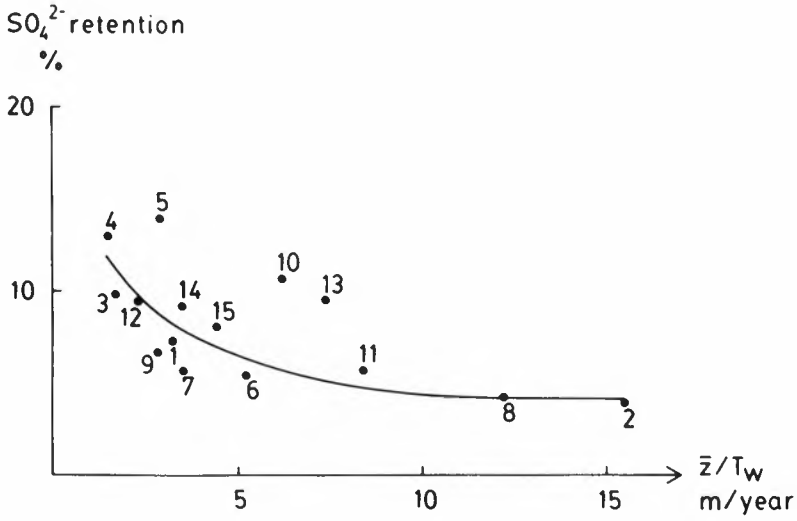

Fig. 39. As Fig. 38, but with retention expressed as % and no broken curve.

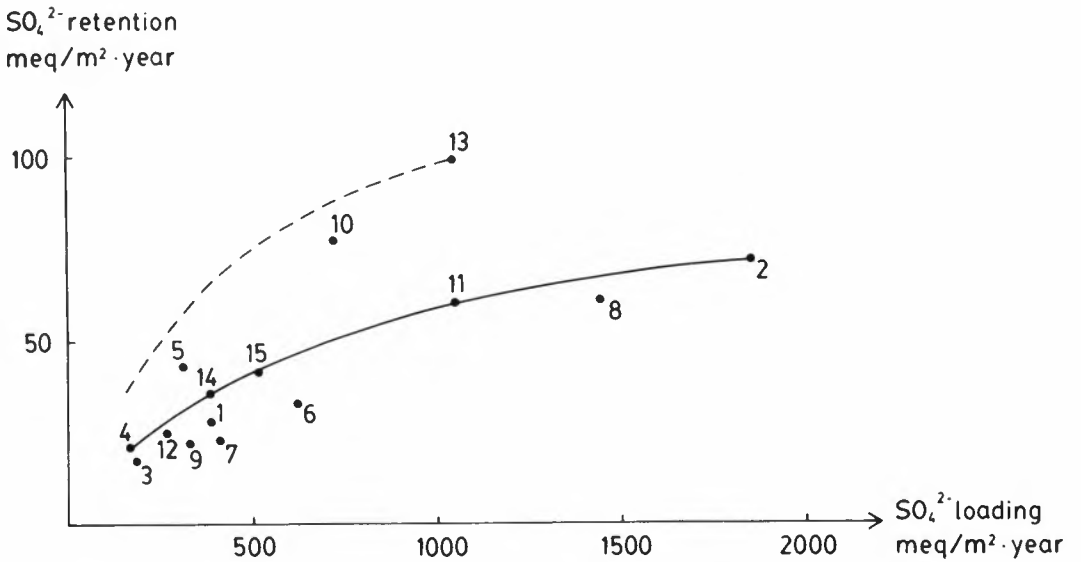

Fig. 40. As Fig. 38, but in relation to sulphate loading.



is somewhat disadvantage due to the fact that the Pt colour is mainly determined by the specific type of humic matter and concentration of iron and manganese.

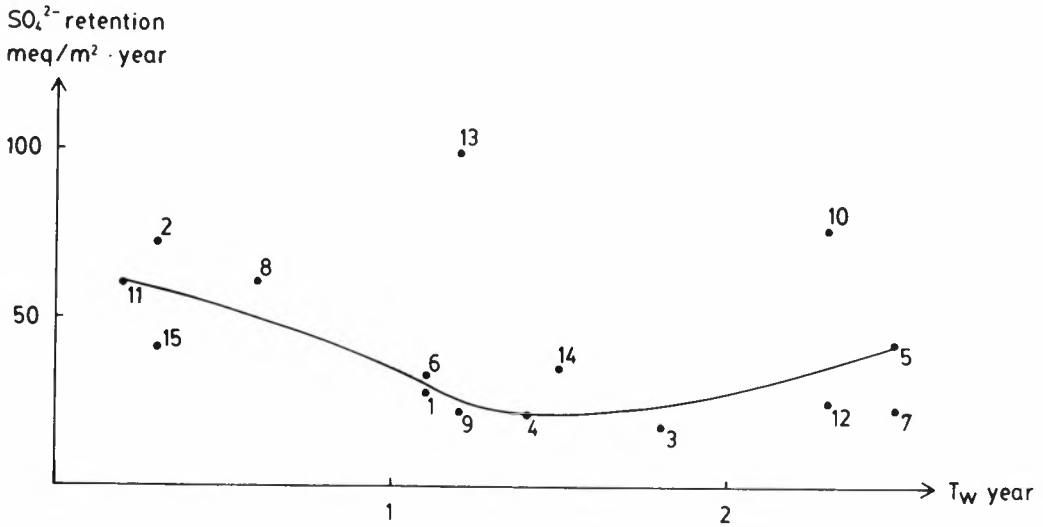

Fig. 41. As Fig. 38, but in relation to hydraulic retention time and no broken curve.

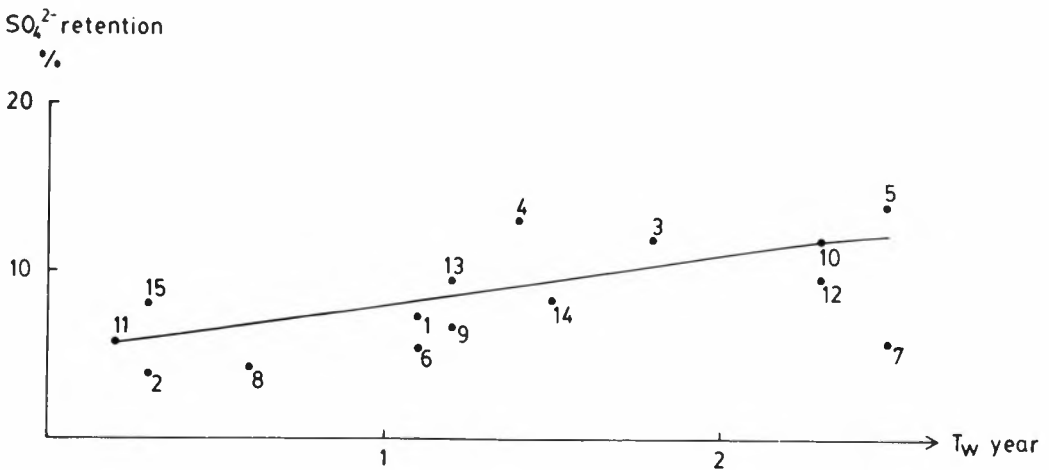

Fig. 42. As Fig. 41, but with retention expressed as %.

$\text{NO}_3^-$  retention  
meq/m<sup>2</sup>·year

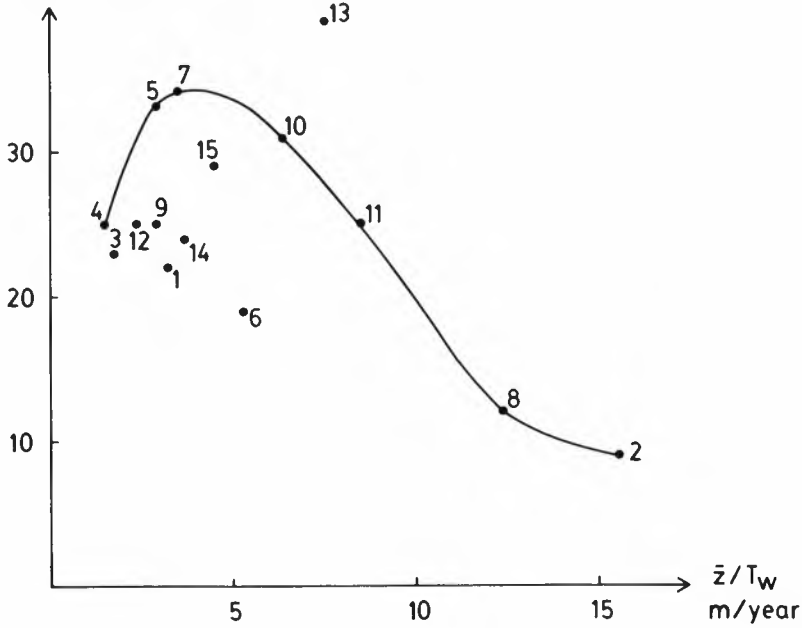

Fig. 43. Nitrate retention as meq/m<sup>2</sup>·year in the lakes in relation to the hydraulic loading. The curve, drawn freehand, describes the hypothetical relation of the plotted values as a basis for discussion.

$\text{NO}_3^-$  retention  
%

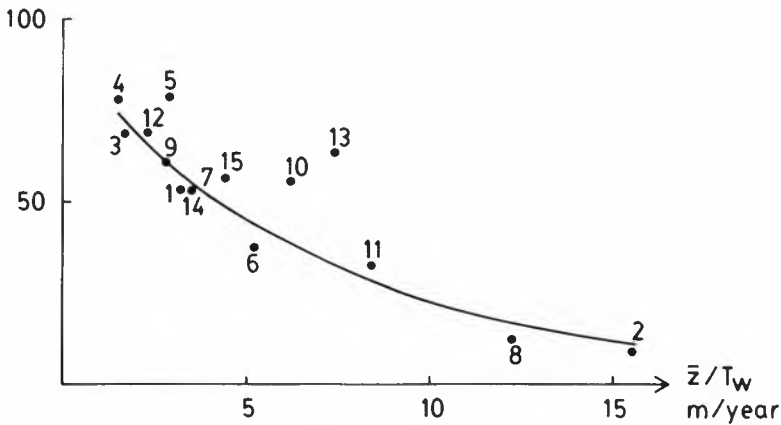

Fig. 44. As Fig. 43, but with retention expressed as %.

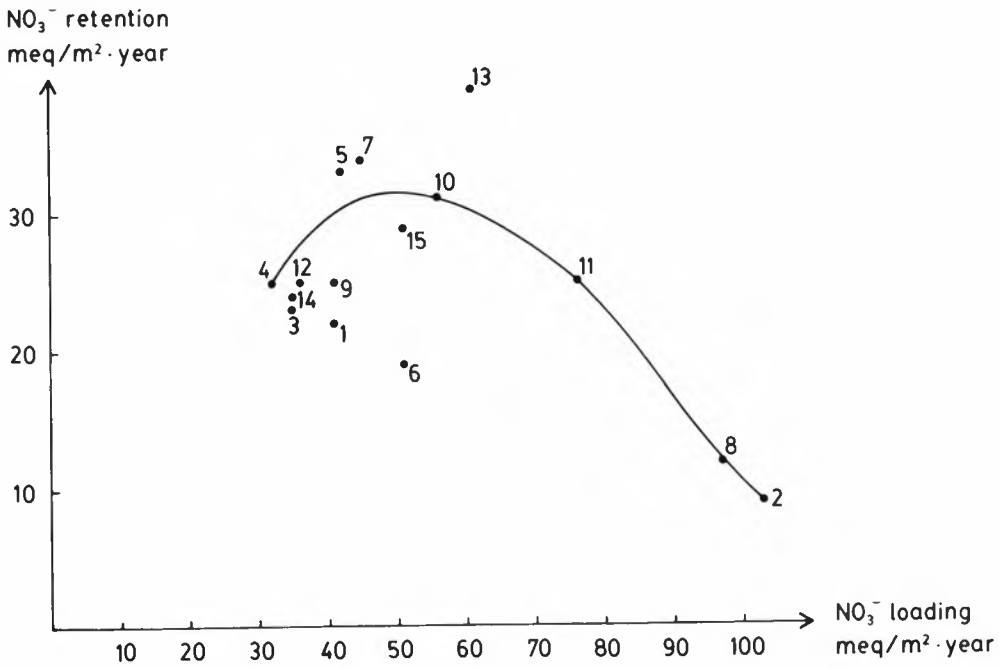

Fig. 45. As Fig. 43, but in relation to nitrate loading.

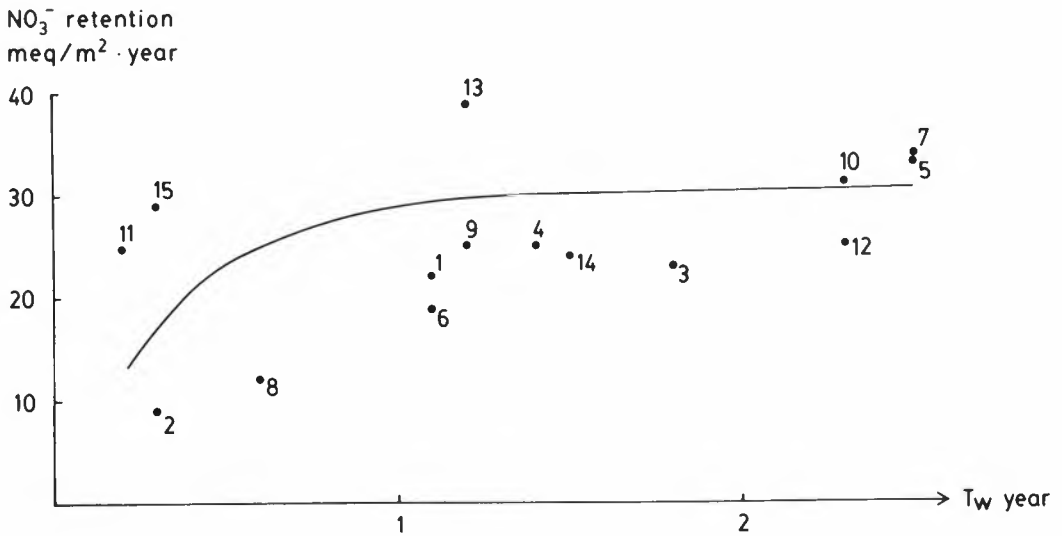

Fig. 46. As Fig. 43, but in relation to hydraulic retention time.

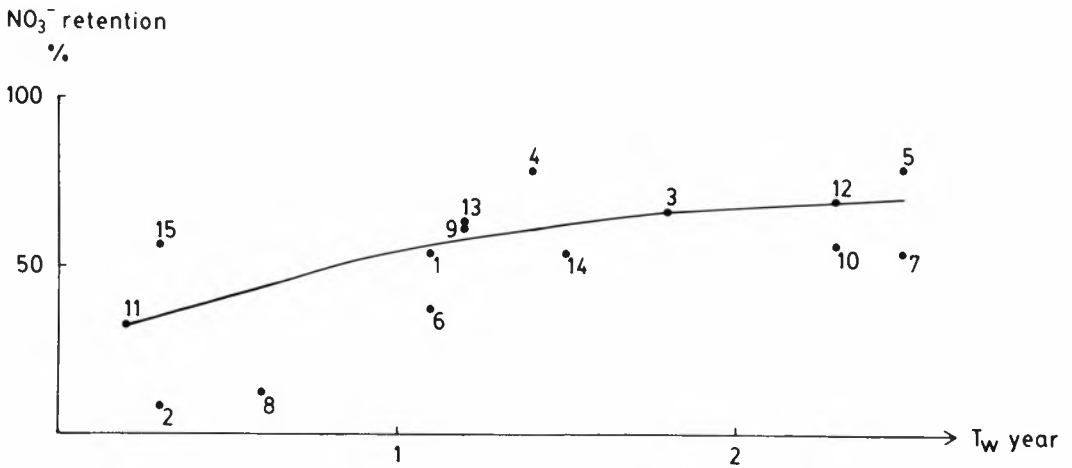

Fig. 47. As Fig. 46, but with retention expressed as %.

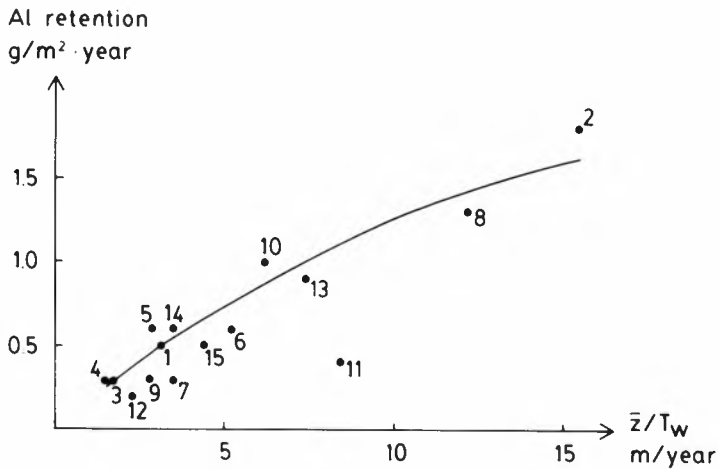

Fig. 48. Aluminium retention as  $\text{g/m}^2 \cdot \text{year}$  in the lakes in relation to hydraulic loading. The curve, drawn freehand, describes the hypothetical relation of the plotted values as a basis for discussion.

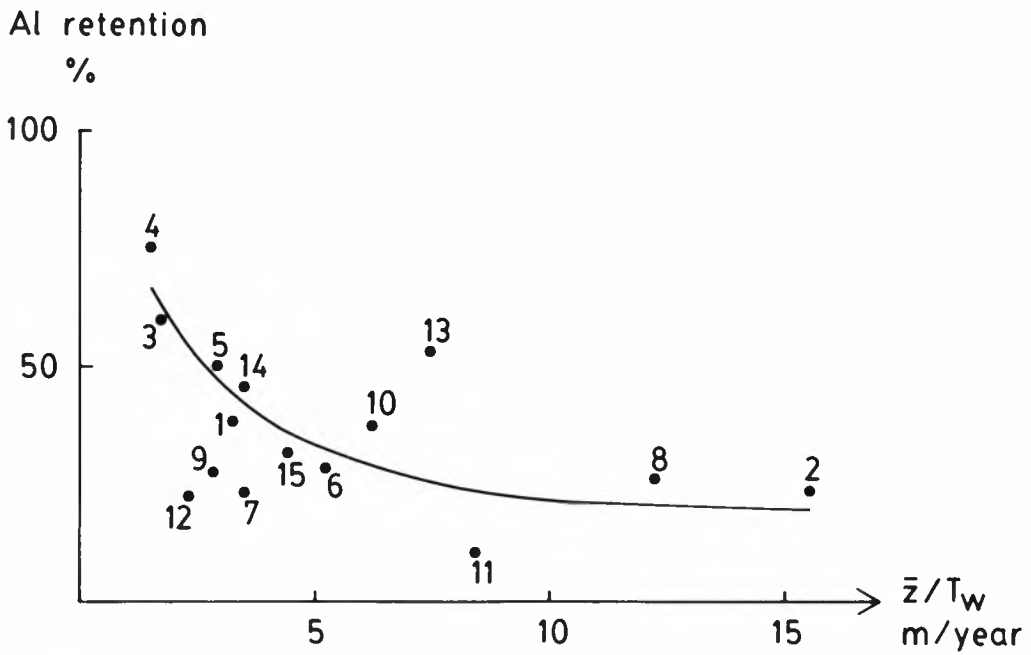

Fig. 49. As Fig. 48, but with retention expressed as %.

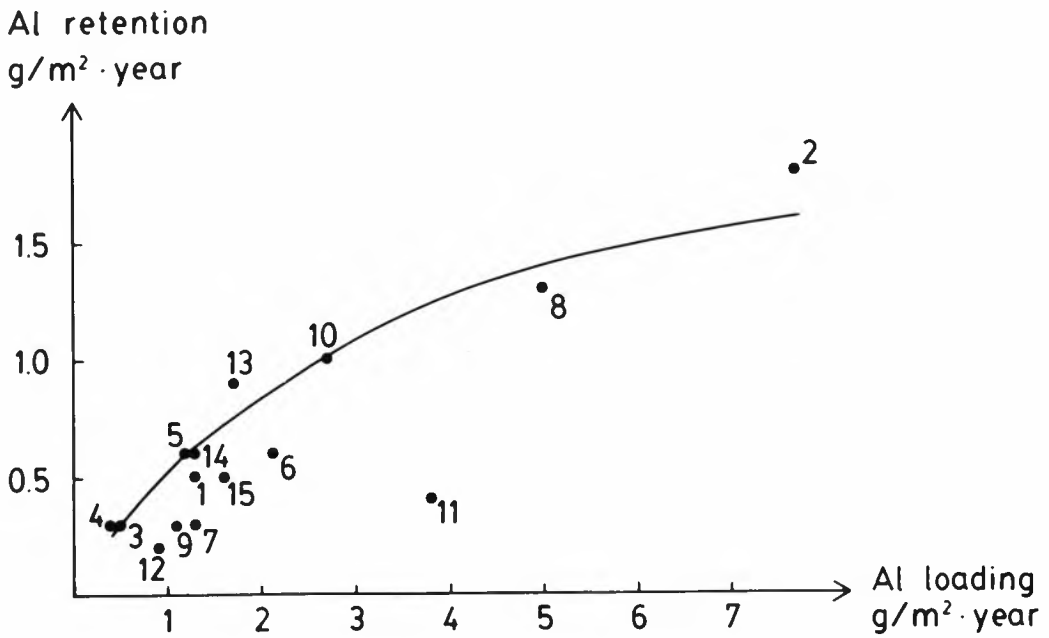

Fig. 50. As Fig. 48, but in relation to aluminium loading.

Al retention  
g/m<sup>2</sup> · year

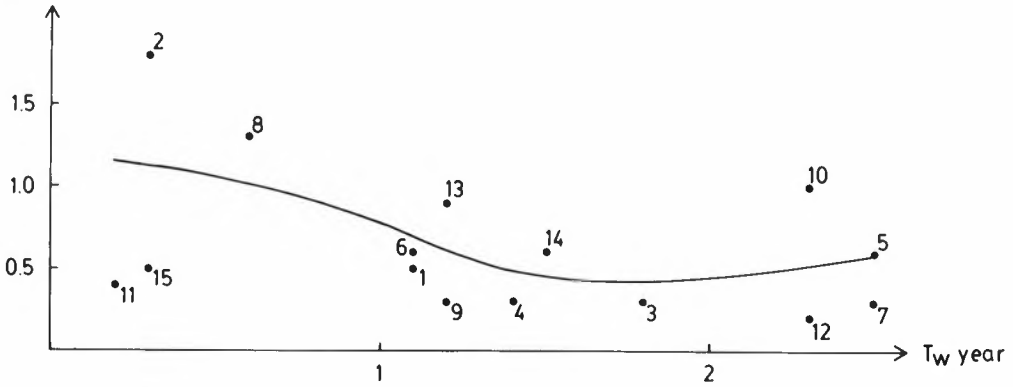

Fig. 51. As Fig. 48, but in relation to hydraulic retention time.

Al retention  
%

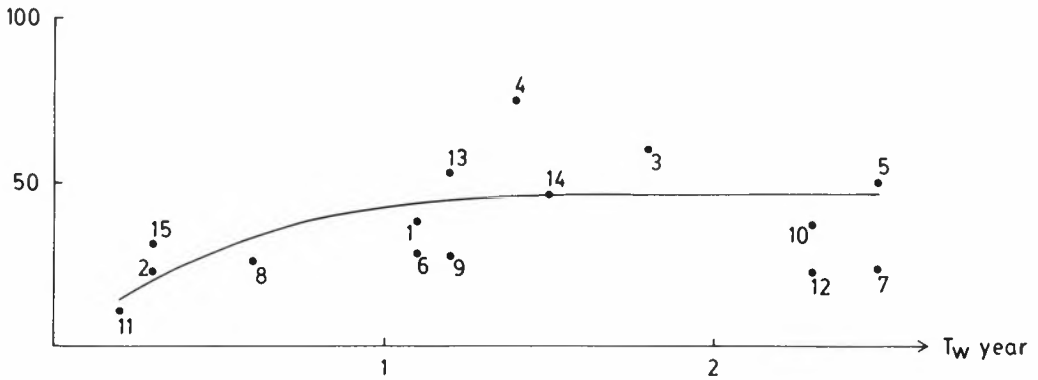

Fig. 52. As Fig. 51, but with retention expressed as %.

"Humic retention"

$\text{g Pt} / \text{m}^2 \cdot \text{year}$

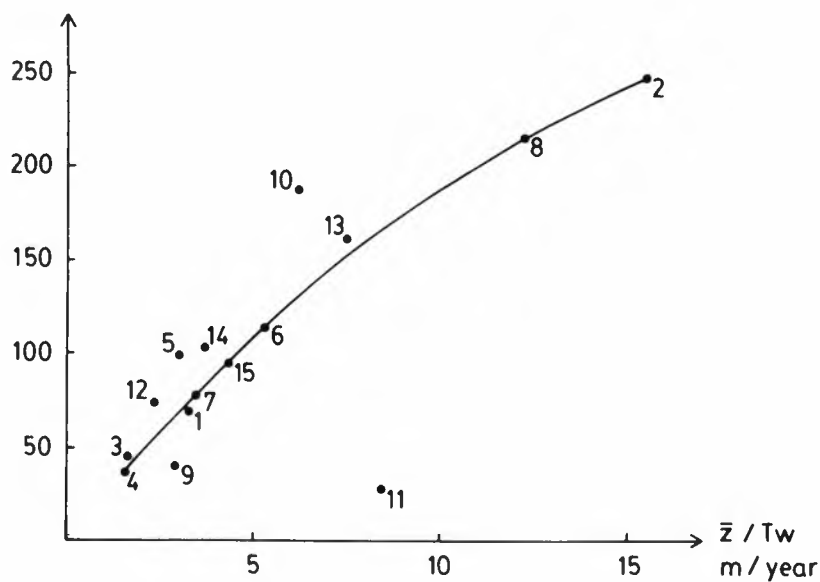

Fig. 53. «Humic retention» as  $\text{g Pt} / \text{m}^2 \cdot \text{year}$  in the lakes in relation to hydraulic loading. The curve, drawn freehand, describes the hypothetical relation of the plotted values as a basis for discussion.

"Humic retention"

%

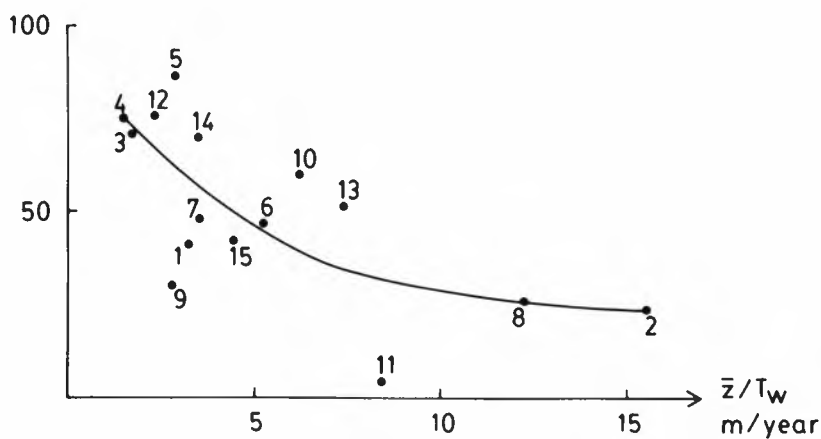

Fig. 54. As Fig. 53, but with retention expressed as %.

"Humic retention"  
gPt/m<sup>2</sup> · year

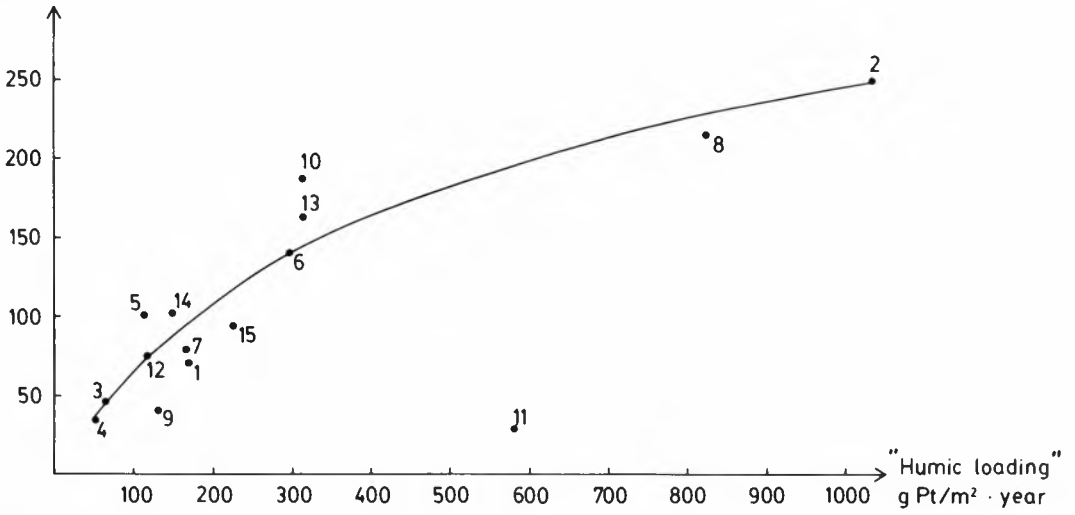

Fig. 55. As Fig. 53, but in relation to «humic loading».

"Humic retention"  
gPt/m<sup>2</sup> · year

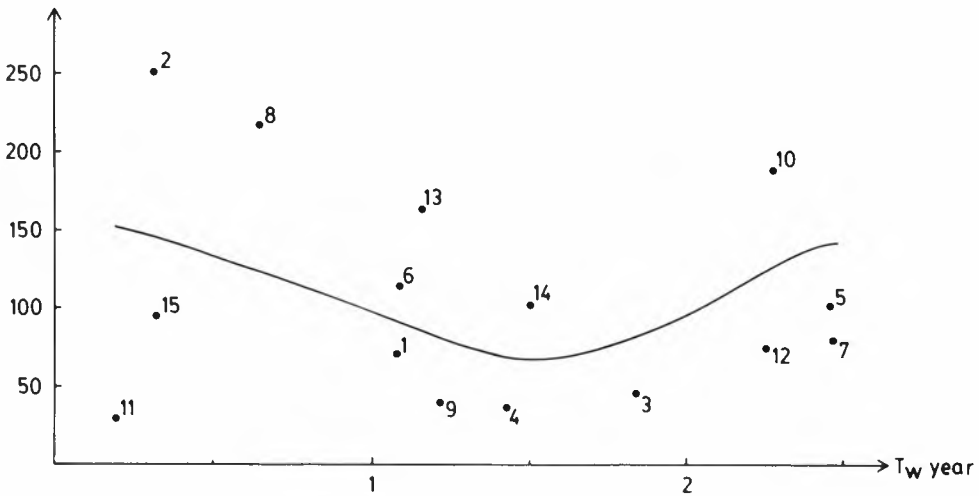

Fig. 56. As Fig. 53, but in relation to hydraulic retention time.



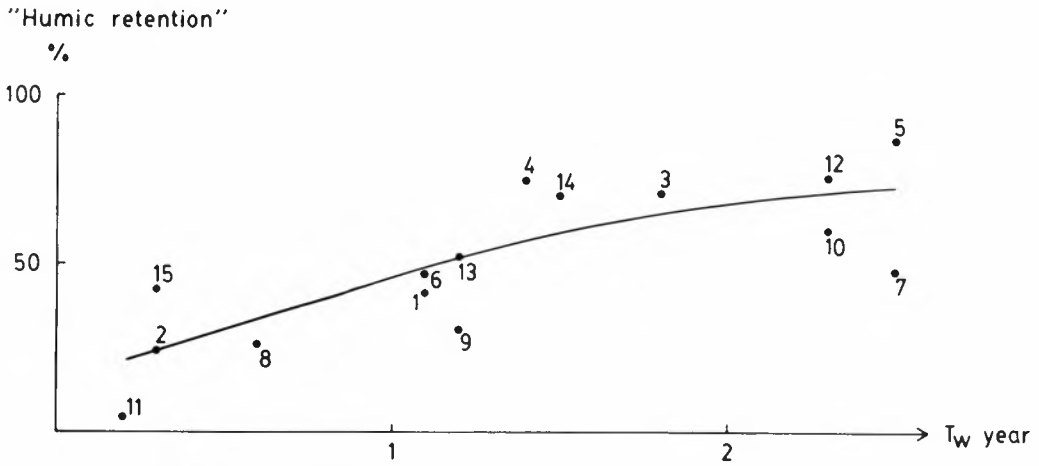

Fig. 57. As Fig. 56, but with retention expressed as %.

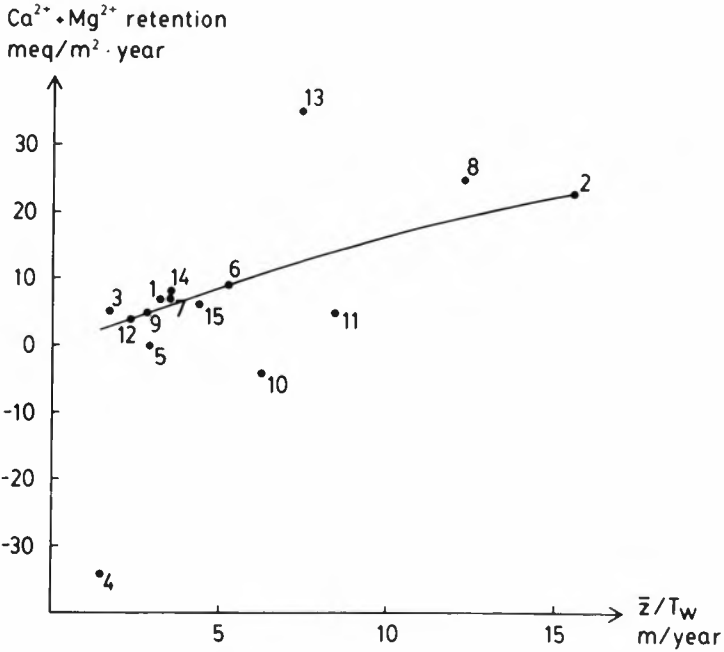

Fig. 58. Calcium plus magnesium retention as  $meq/m^2 \cdot year$  in the lakes in relation to hydraulic loading. The curve, drawn freehand, describes the hypothetical relation of the plotted values as a basis for discussion.

### Calcium and magnesium

The retention of these components is generally small, as shown in Figs. 58, 59, 60, 61 and 62. Lakes 4, 5 and 10 have even shown zero or negative values. The highest value is represented by Lake 13. These four lakes belong to the deviation lakes. Lake 4 is limed and Lakes 5 and 10 probably receive groundwater richer in Ca (Mg) than the inflowing water which was analysed. Lake 13 receives relatively much Ca via the inflowing water, which characterizes the retention. Lake 11, which has shown low retention for «humic substances» and Al, also shows low retention for Ca and Mg. This may be due to leaching of components from the sediments in periods with relatively strong acid waters and high flow-through rate.

### Sodium

These retention values are also small and show very roughly similar relations as Ca and Mg. This is shown in Figs. 63, 64, 65, 66 and 67. Sodium is considered a conservative component (biologically inactive) and the findings here should therefore be reasonable.

The zero retention in Lakes 4 and 10 may be seen in connection with the liming and the supposed ground water influx. The negative value in Lake 5 supports the previously assumed ground water influx.

### Potassium

Figs. 68, 69, 70, 71 and 72 show the five relations of the K retention and the patterns resemble those of hydronium (except Lake 13). This may indicate that K retention is involved in some of the same mechanisms providing for the hydronium retention (adsorption and ion-exchange).

### Reactive silicate

The retention of this component is presented in Figs. 73, 74, 75, 76 and 77. The relations indicated by the discussion curves are similar to those for the «humic retention». This bears witness to a connection between these two components. Mortimer (1941/42) and Tessenow (1966) have described Si increase in the deep water of lakes due to release from the sediments where humic substances (and iron) were involved. The relatively low retention in Lakes 11 and 13 is probably due to a shallow basin, highly influenced by winds and a relatively high pH, respectively. The solubility of Si increases with increasing pH, which may also be of importance for Lake 13.

### Iron

The retention values of Fe in relation to  $Z/T_w$ , Fe loading and  $T_w$  are shown in Figs. 78, 79, 80, 81 and 82; the picture resembles that of Al. This is not unexpected, because these two components are often correlated to each other (see Chapter VI).

### Phosphorus

The relations in the lakes' P retention, as shown in Figs. 83, 84, 85, 86 and 87, are roughly speaking the same as in the «humic retention». This fits well with the correlation between P and water colour ( $r = 0.876$ ) presented in Chapter VI. This appears when comparing the discussion curves. The two deviation lakes, 10 and 13, seem to obtain relatively high retention values and Lake 11 the opposite, namely low values. Great depth and neutral pH may possibly favour P retention, and shallow water, together with strong wind influence, may prevent P retention.

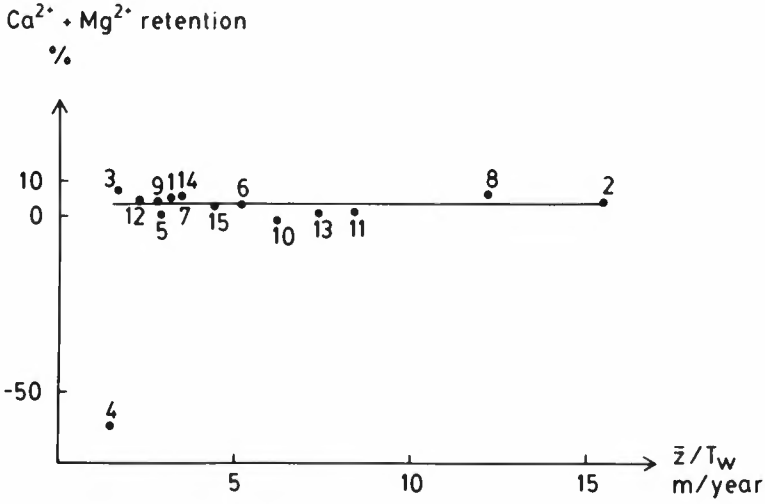

Fig. 59. As Fig. 58, but with retention expressed as %.

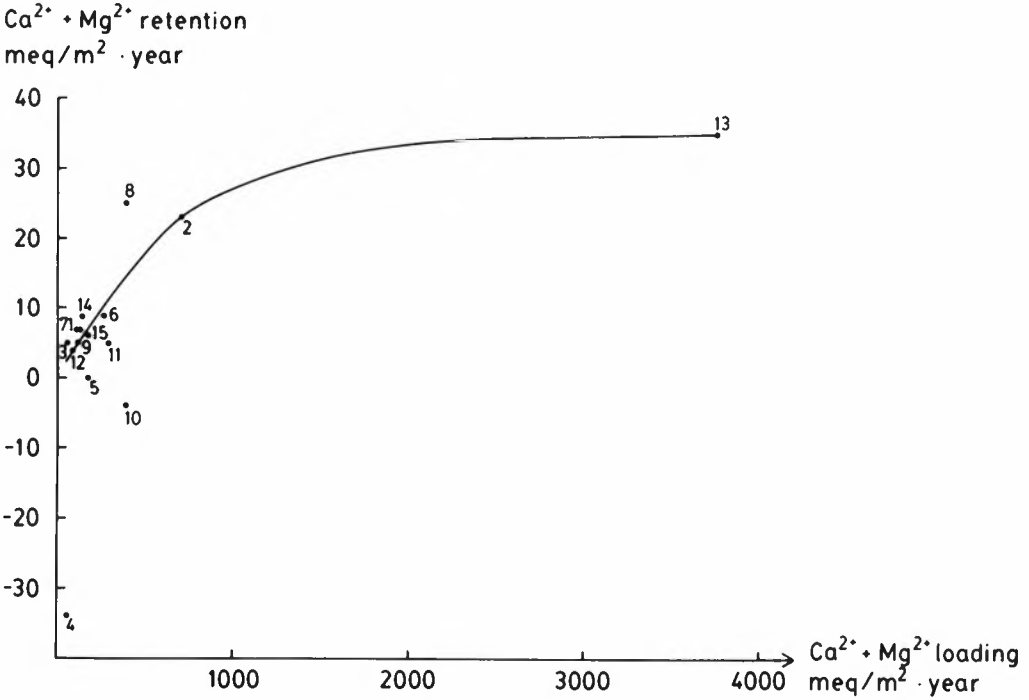

Fig. 60. As Fig. 58, but in relation to calcium plus magnesium loading.

Ca<sup>2+</sup> + Mg<sup>2+</sup> retention  
meq/m<sup>2</sup> · year

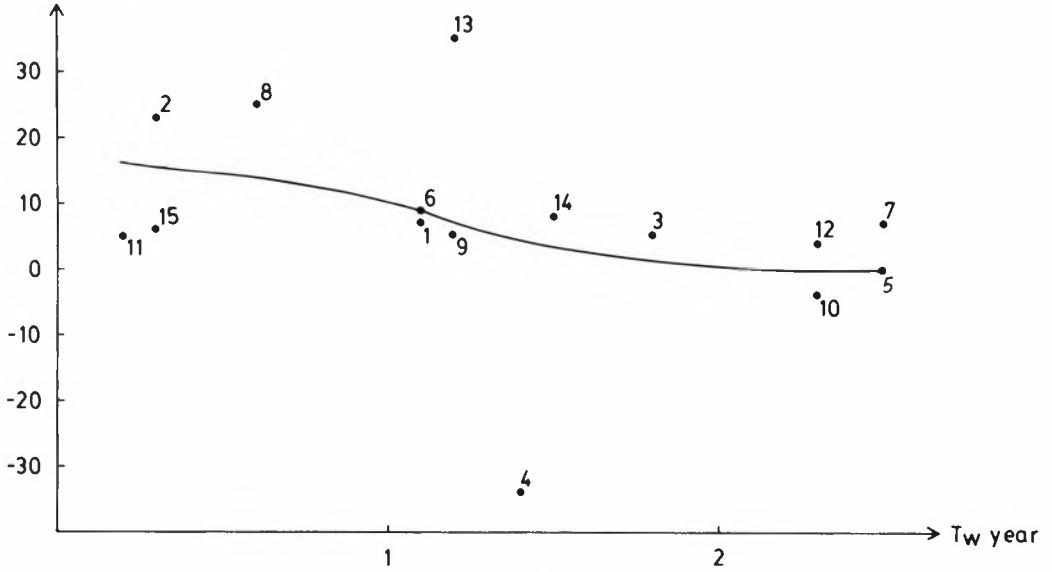

Fig. 61. As Fig. 58, but in relation to hydraulic retention time.

Ca<sup>2+</sup> + Mg<sup>2+</sup> retention  
%

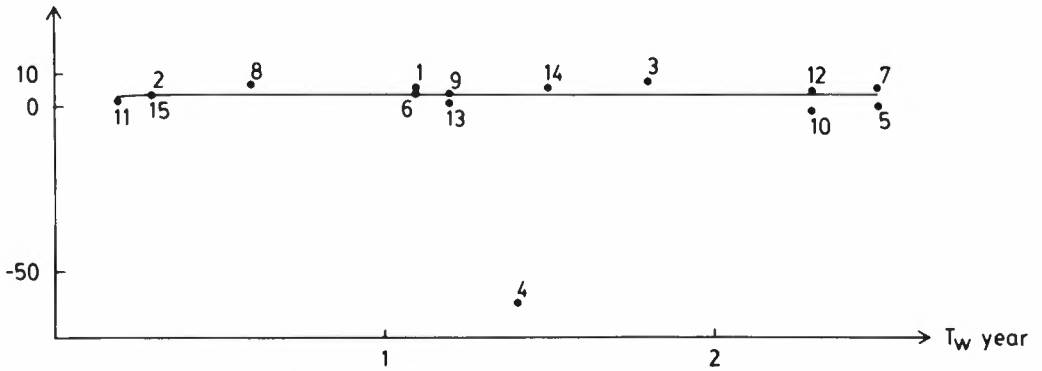

Fig. 62. As Fig. 61, but with retention expressed as %.

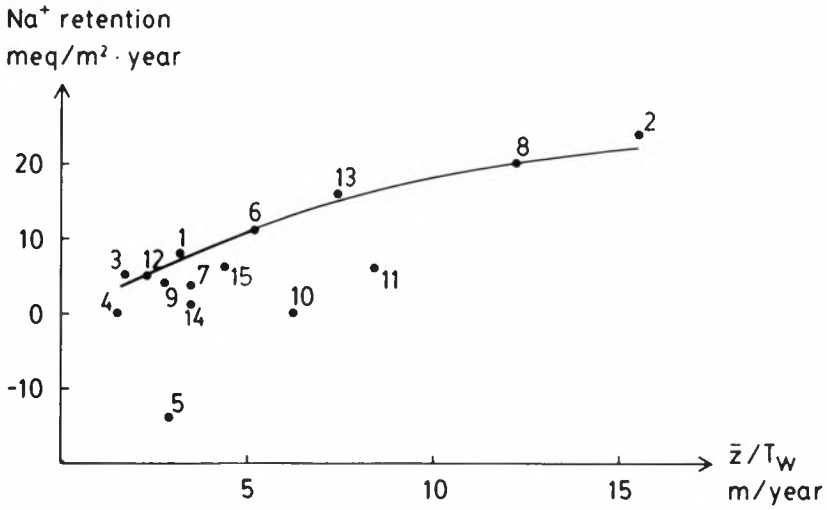

Fig. 63. Sodium retention as meq/m<sup>2</sup>·year in the lakes in relation to hydraulic loading. The curve, drawn freehand, describes the hypothetical relation of the plotted values as a basis for discussion.

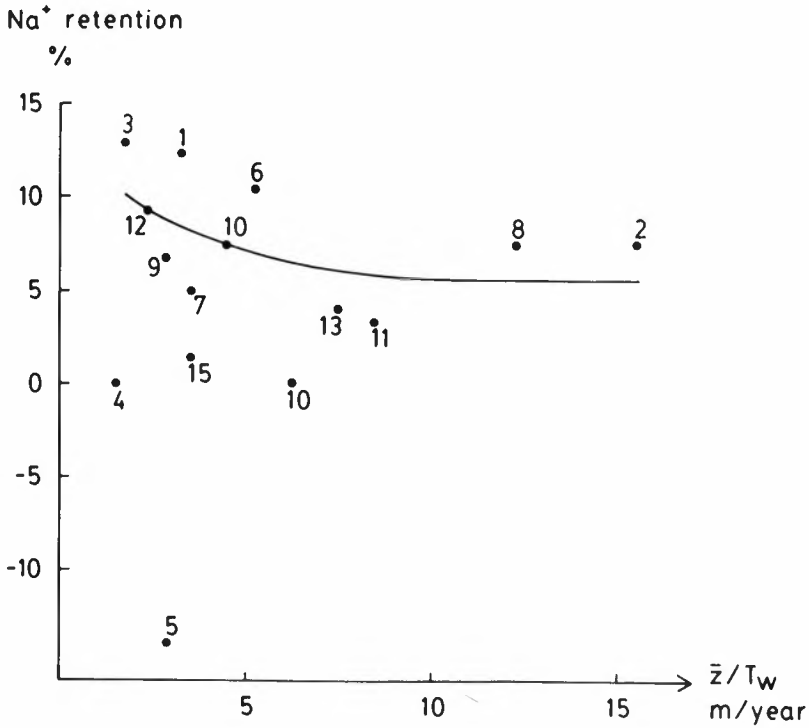

Fig. 64. As Fig. 63, but with retention expressed as %.

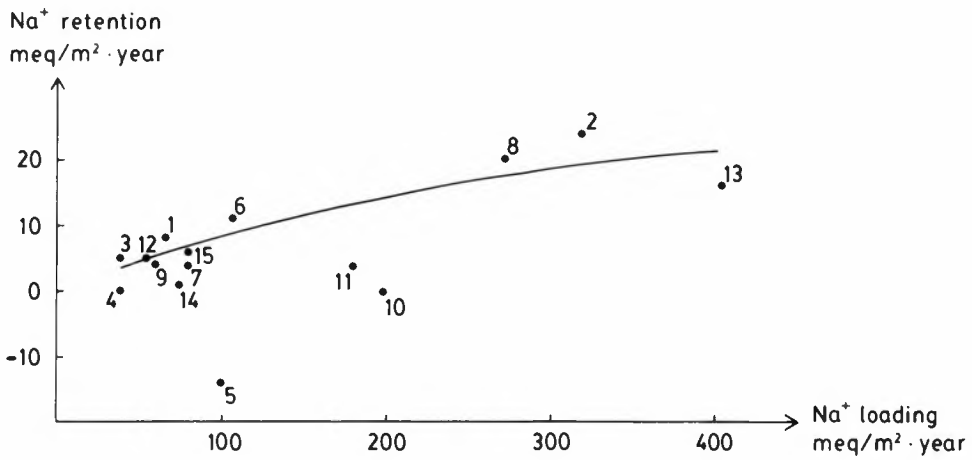

Fig. 65. As Fig. 63, but in relation to sodium loading.

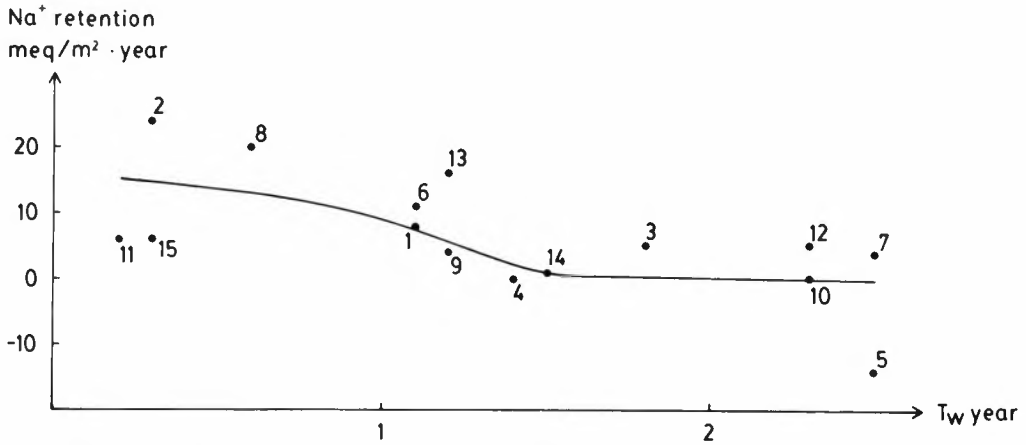

Fig. 66. As Fig. 63, but in relation to hydraulic retention time.

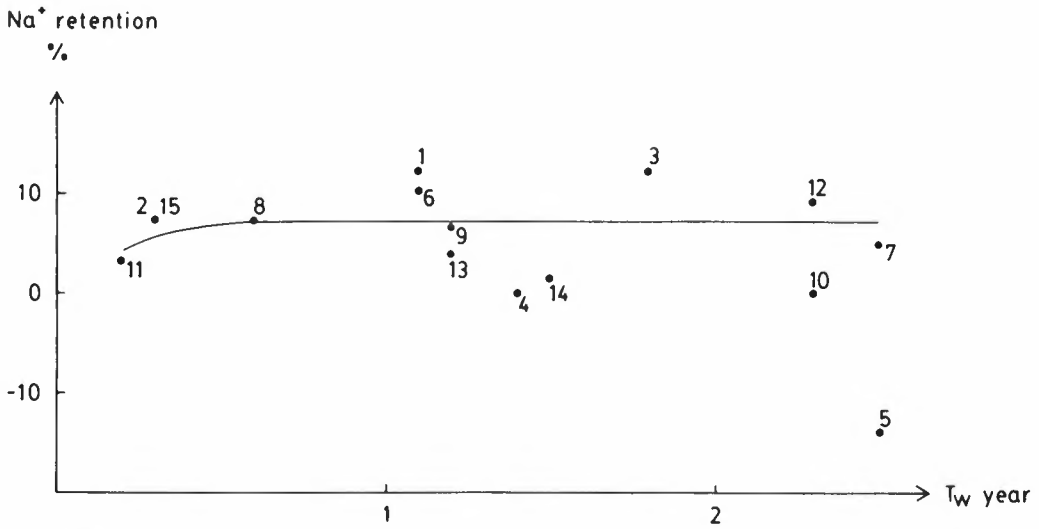

Fig. 67. As Fig. 66, but with retention expressed as %.

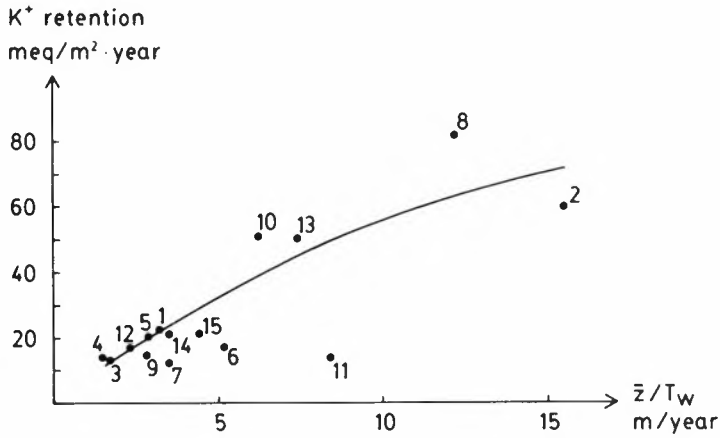

Fig. 68. Potassium retention as meq/m<sup>2</sup>·year in the lakes in relation to hydraulic loading. The curve, drawn freehand, describes the hypothetical relation of the plotted values as a basis for discussion.

$K^+$  retention  
%

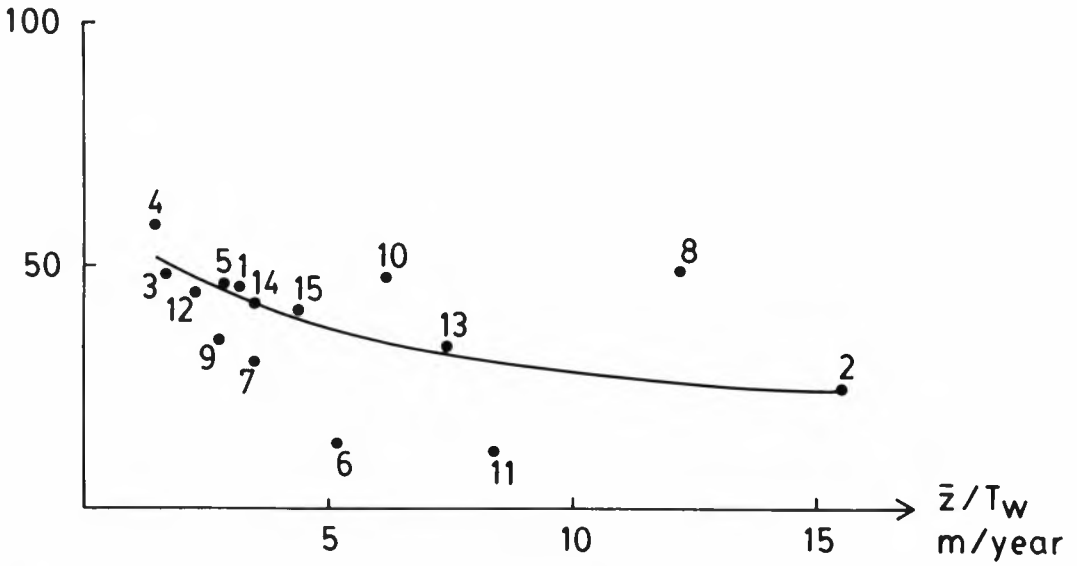

Fig. 69. As Fig. 68, but with retention expressed as %.

$K^+$  retention  
meq/m<sup>2</sup> · year

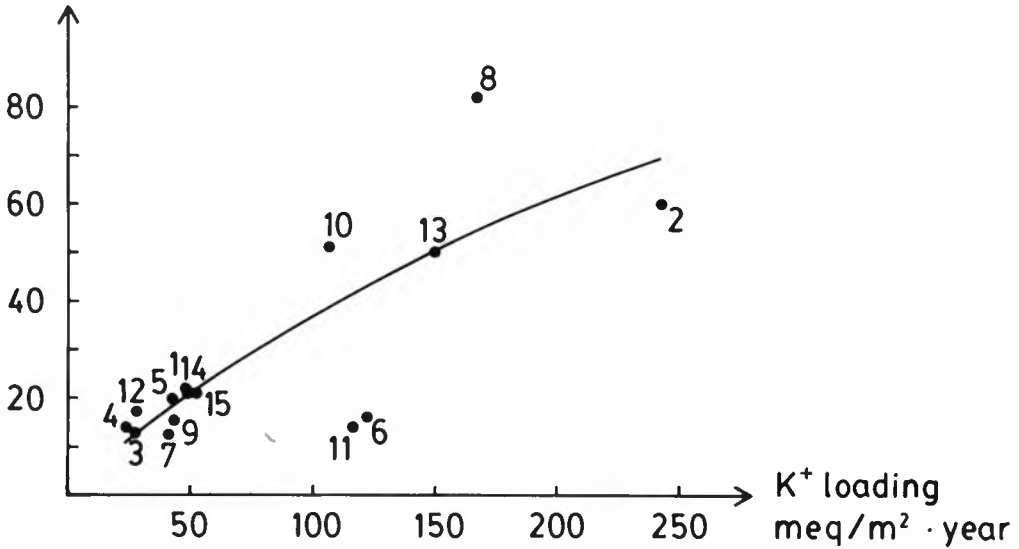

Fig. 70. As Fig. 68, but in relation to potassium loading.



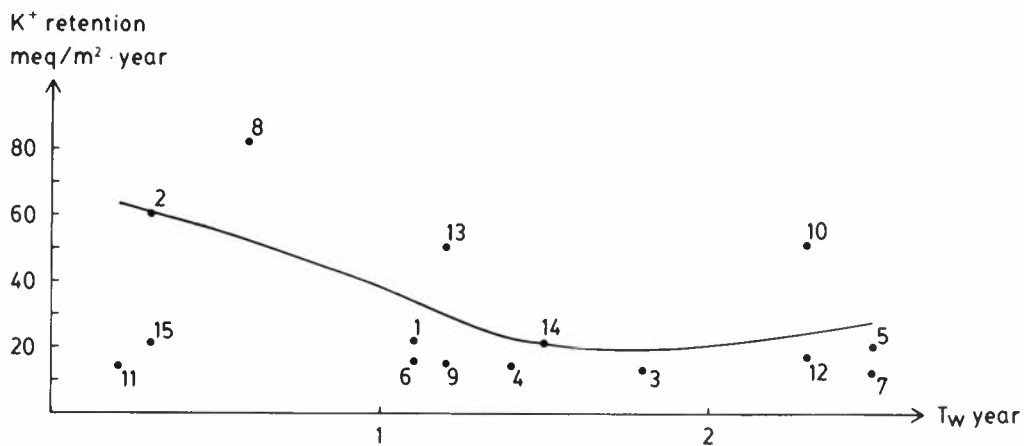

Fig. 71. As Fig. 68, but in relation to hydraulic retention time.

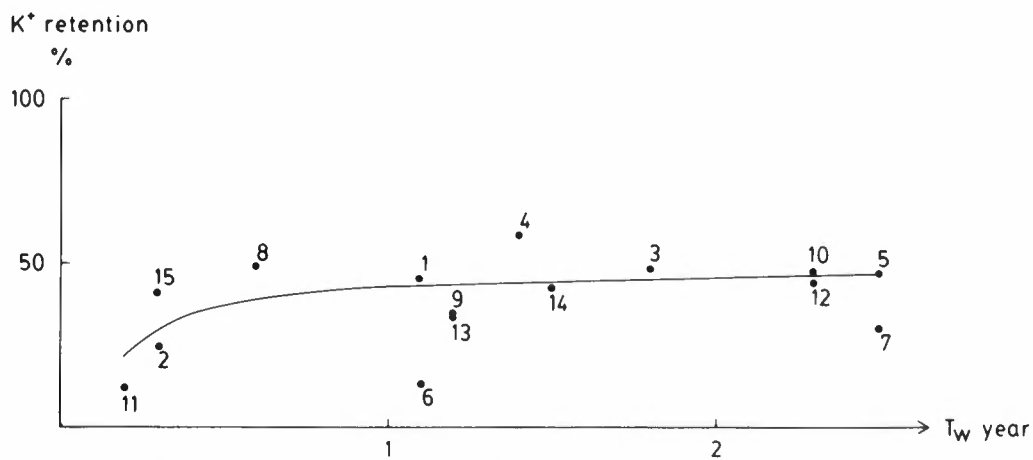

Fig. 72. As Fig. 71, but with retention expressed as %.

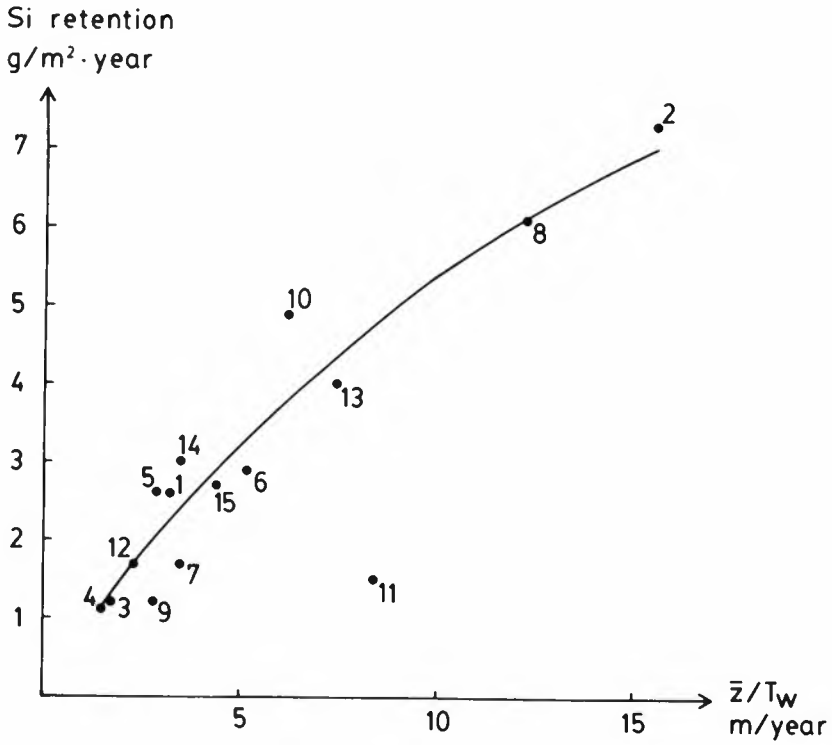

Fig. 73. Silicium (reactive silicate) retention as g/m<sup>2</sup>·year in the lakes in relation to hydraulic loading. The curve, drawn freehand, describes the hypothetical relation of the plotted values as a basis for discussion

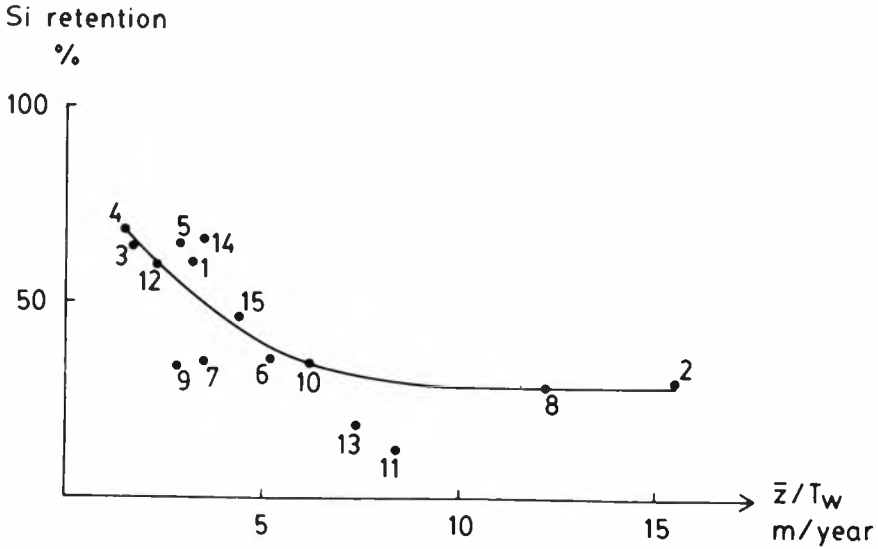

Fig. 74. As Fig. 73, but with retention expressed as %.

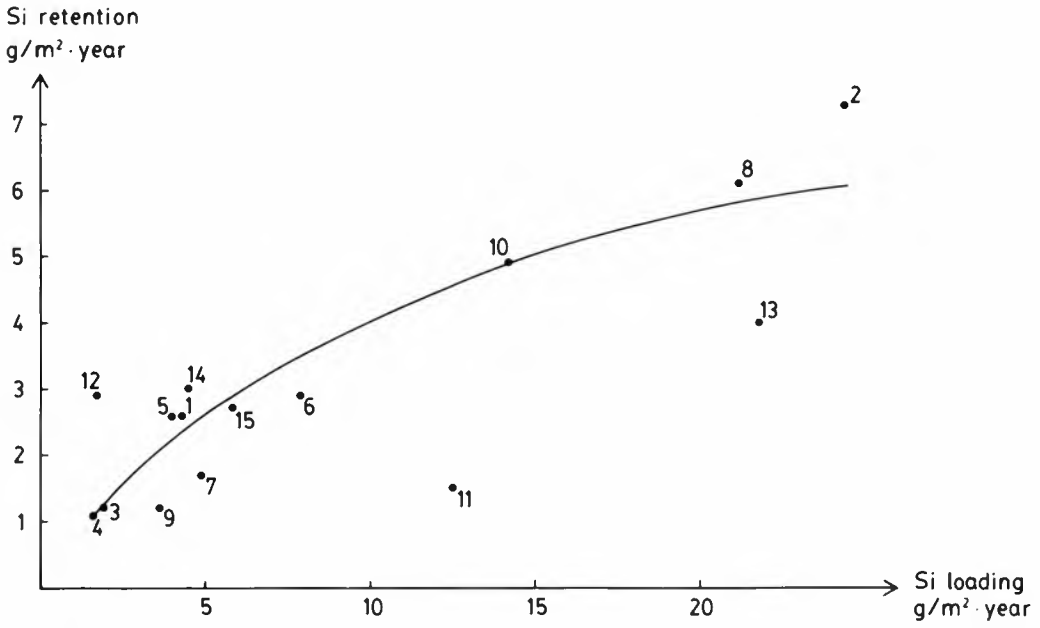

Fig. 75. As Fig. 73, but in relation to silicium loading.

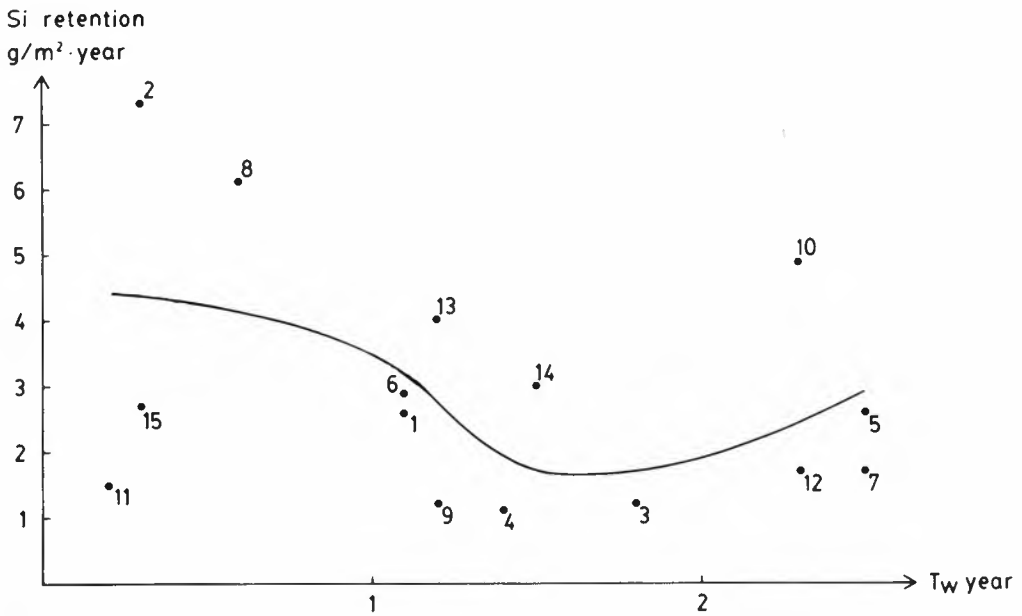

Fig. 76. As Fig. 73, but in relation to hydraulic retention time.

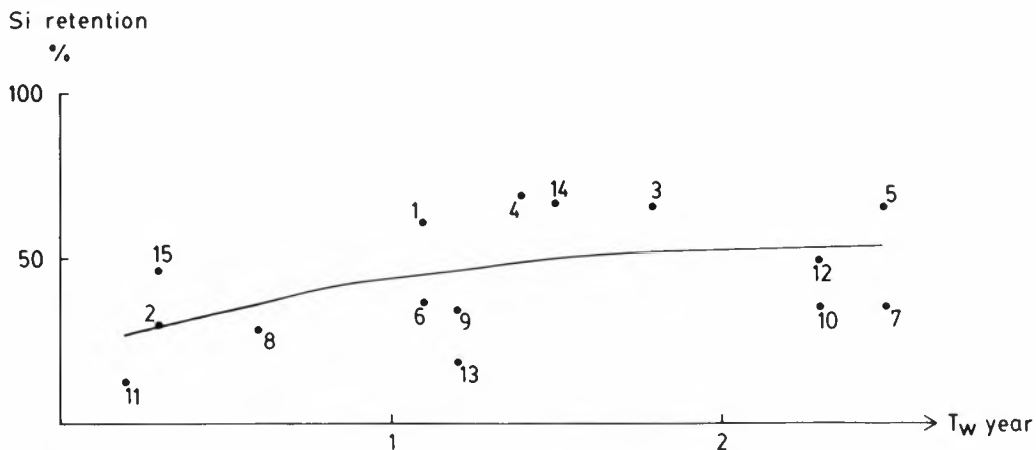

Fig. 77. As Fig. 76, but with retention expressed as %.

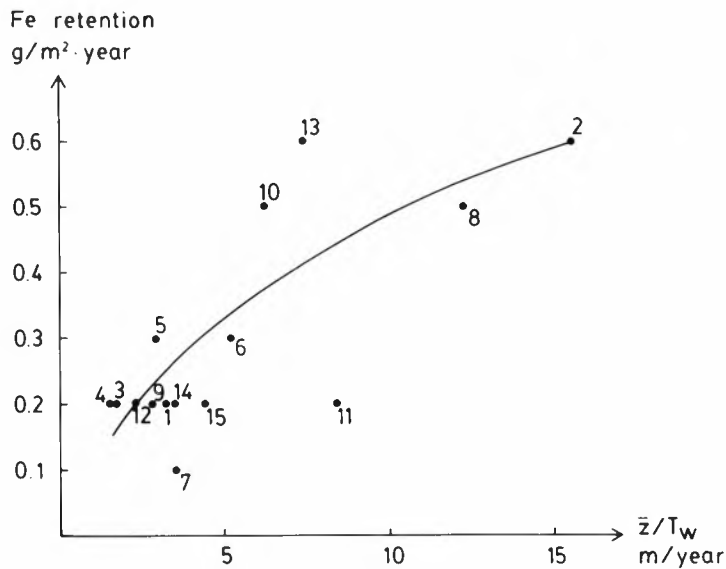

Fig. 78. Iron retention as  $\text{g/m}^2 \cdot \text{year}$  in the lakes in relation to hydraulic loading. The curve, drawn freehand, describes the hypothetical relation of the plotted values as a basis for discussion.

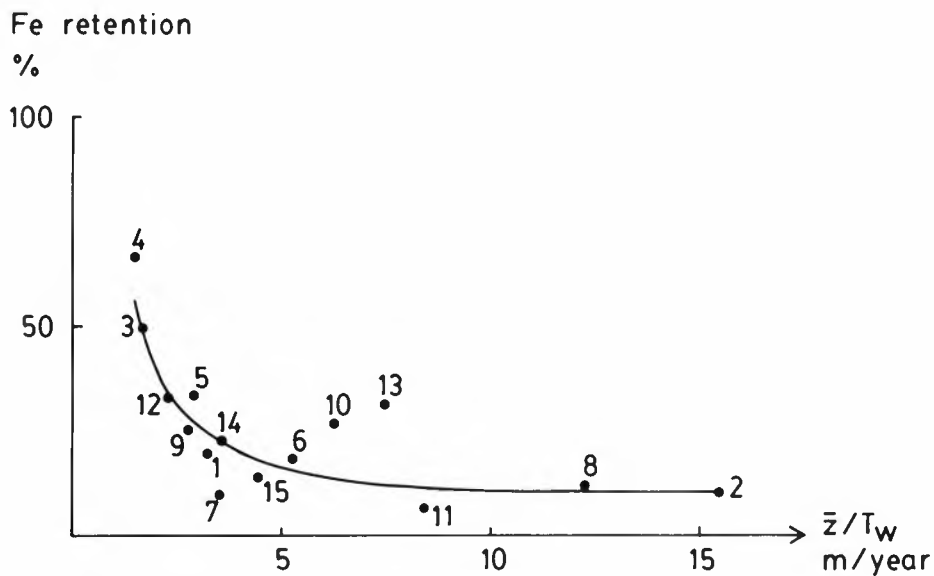

Fig. 79. As Fig. 78, but with retention expressed as %.

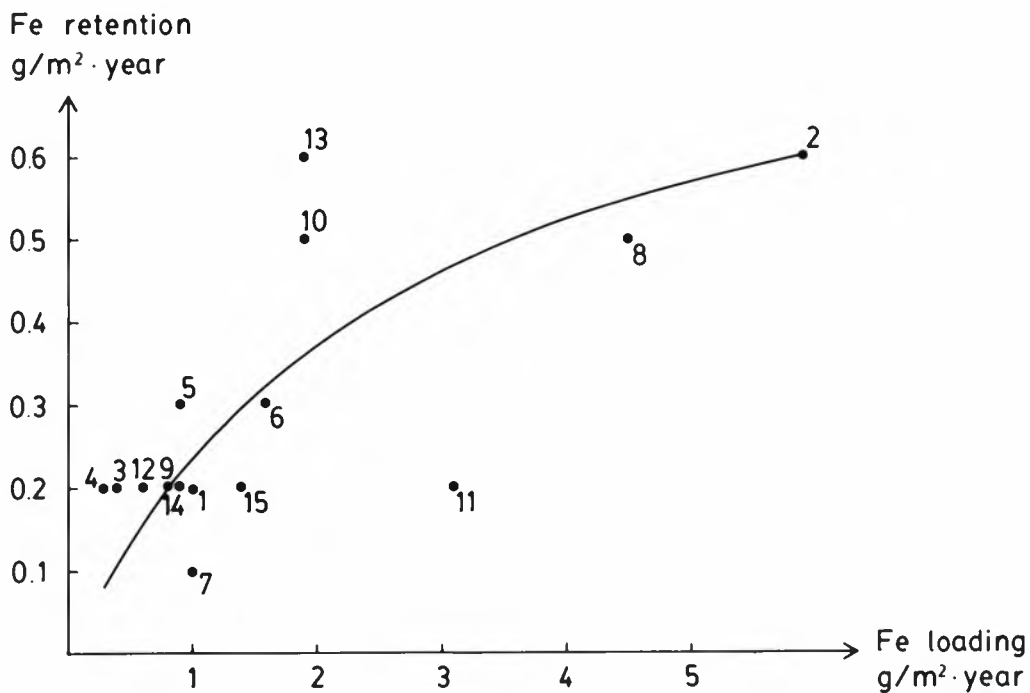

Fig. 80. As Fig. 78, but in relation to iron loading.

Fe retention  
g/m<sup>2</sup> · year

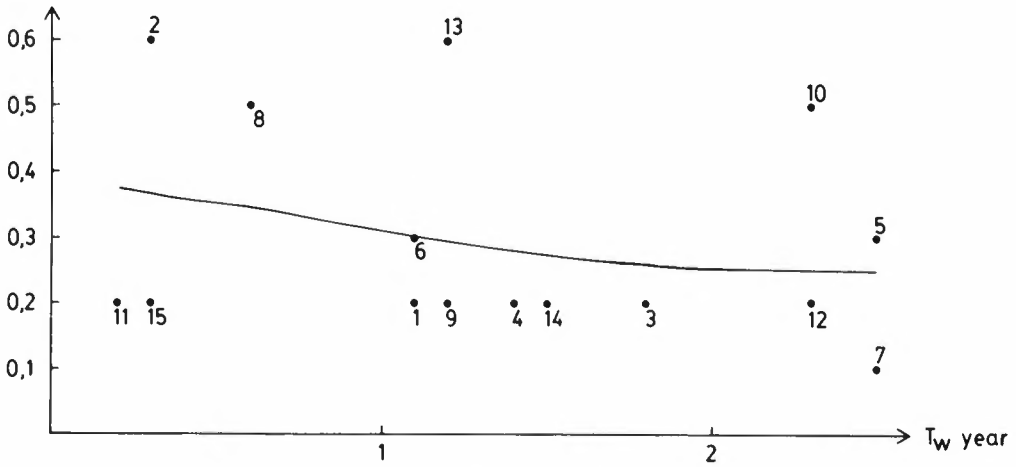

Fig. 81. As Fig. 78, but in relation to hydraulic retention time.

Fe retention  
%

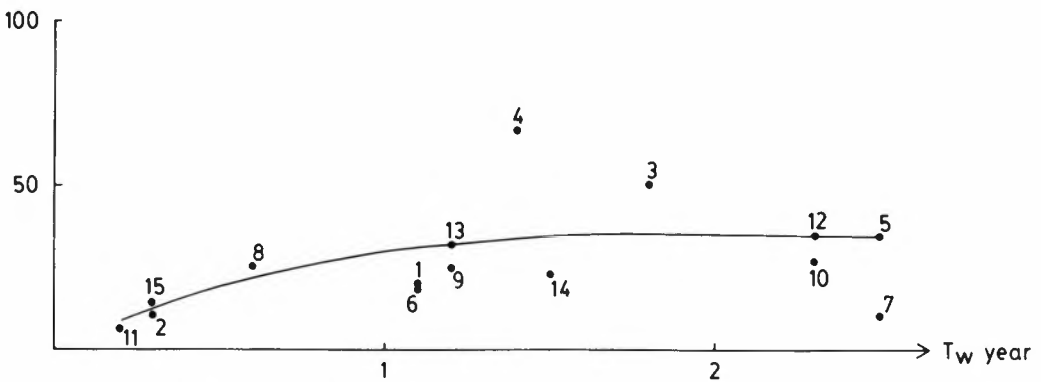

Fig. 82. As Fig. 81, but with retention expressed as %.

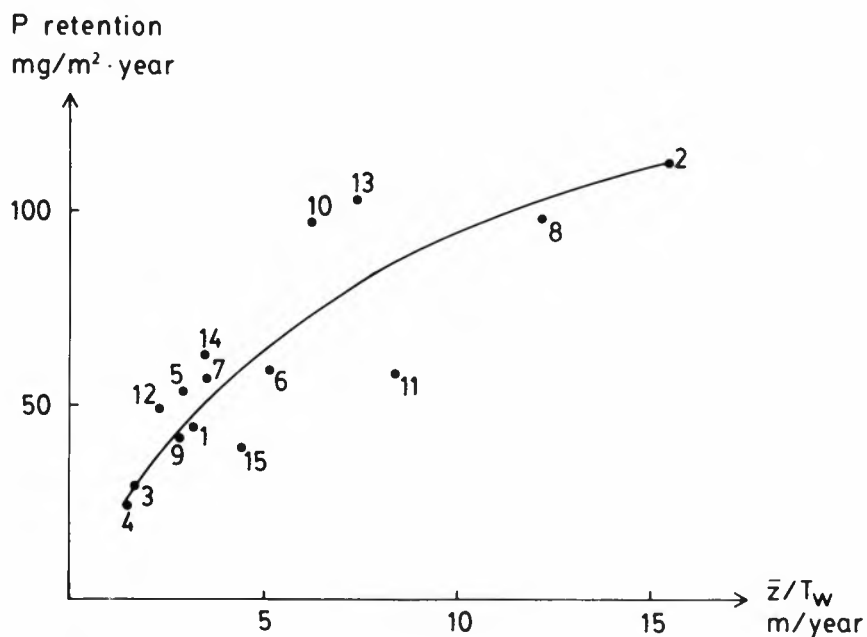

Fig. 83. Phosphorus retention as mg/m<sup>2</sup> year in the lakes in relation to hydraulic loading. The curve, drawn freehand, describes the hypothetical relation of the plotted values as a basis for discussion.

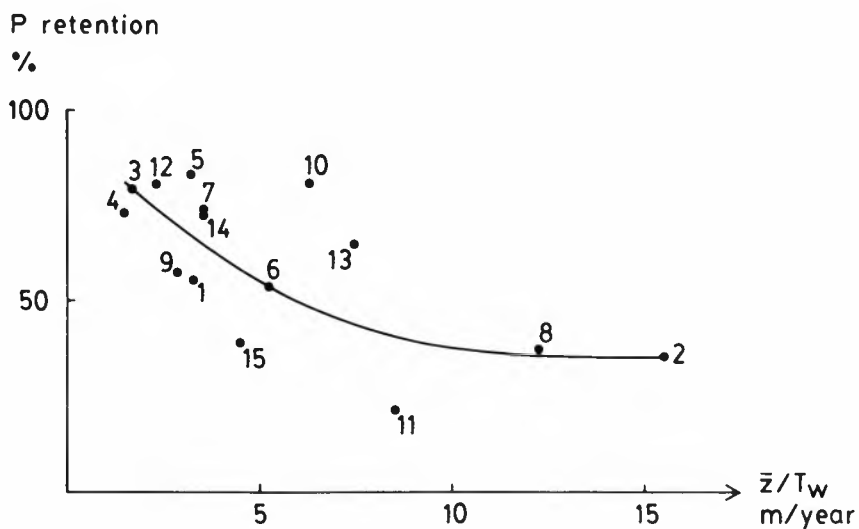

Fig. 84. As Fig. 83, but with retention expressed as %.

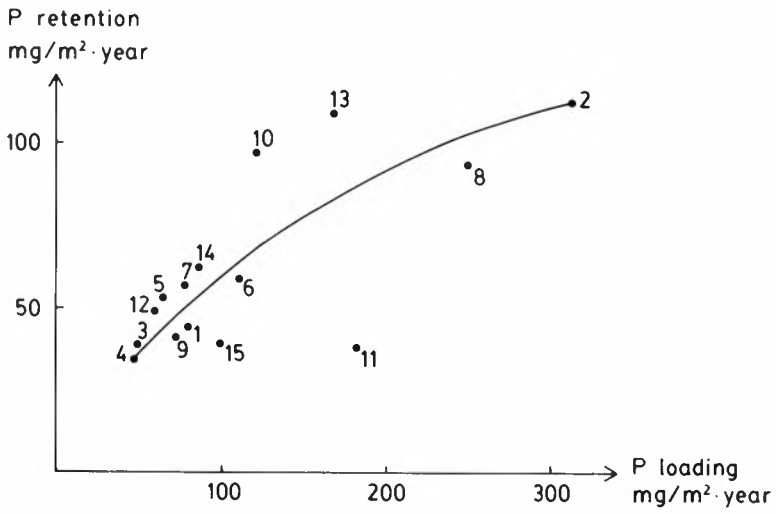

Fig. 85. As Fig. 83, but in relation to phosphorus loading.

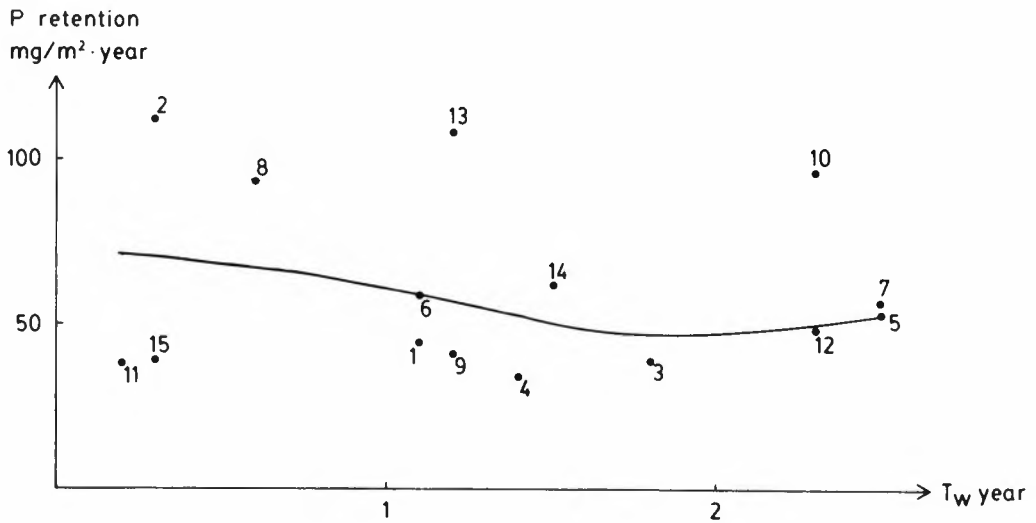

Fig. 86. As Fig. 83, but in relation to hydraulic retention time.



The percentage P retention in relation to  $T_w$  (Fig. 87) shows a closer distribution around the discussion curve than all the other components treated here. This indicates that the P retention is especially determined by the residence time, i.e. by processes in the lake basin. In addition to chemical precipitation P is an important nutrient for the algae. At  $T_w$  of 2-2.5 the percentage P retention seems to level off. Consequently it should not be possible to increase the P retention further by increasing the  $T_w$  to more than 2.5 years. The final level of P retention in these lakes seems to be 75-80 %. The mean yearly P retention as % of some Scandinavian lakes related to  $T_w$  has been given by Persson & Broberg (1985). The Finnemarka lakes seem roughly to be in agreement with their statement.

#### A m m o n i a

This component deviates from the others regarding retention, as all lakes show negative or zero  $NH_4$  retention. As a consequence,  $NH_4$  is presented as net export in relation to the same parameters as before. This can be seen in Figs. 88, 89, 90, 91 and 92. The discussion curves have been difficult to draw in these diagrams. Therefore no curve has been drawn in Fig. 90. The net export of  $NH_4$  is supposed to be independent of the  $NH_4$  loading, as shown in the diagram.

The mechanism behind this  $NH_4$  export may be decomposition of allochthonous organic matter (humic substances) with release of  $NH_4$ . Besides the bacteria, the aquatic animals, e.g. water boatmen, are of importance in this respect. Experiments with undisturbed sediment cores in the laboratory also indicate the production of  $NH_4$  in the lakes (see Chapter V). Nitrification is inhibited in acid lakes (Wetzel 1975, Chen et al. 1972) and this will probably also contribute to the net export found. The zero net export of  $NH_4$  from Lake 13 may support this (lake not acidified).

#### C h l o r i d e

This component has not shown any significant lake retention and the results are consequently not presented. Due to the fact that Cl is assumed to be a conservative component (e.g. Gjessing et al. 1976) this is as expected.

The above-mentioned substance retentions can be compared with budgets of other lakes. Unfortunately, there have been few mass balance studies of lakes in undisturbed areas, as pointed out by Schindler et al. (1976) and Wright & Henriksen (1980), who have done such investigations in Canada and Norway respectively. In addition to these, studies have been described by Henriksen & Wright (1977) in Norway, Schindler & Nighswander (1970), de March (1975), Schindler et al. (1986) and Cook et al. (1986) in Canada, Jordan & Likens (1975) in USA and Jansson (1979) and Andersson & Olsson (1985) in Sweden. The research by Cook et al. has treated budgets in connection with experimental lake acidification. It is difficult to make a direct comparison between lakes in Finnemarka and the lakes referred to above, but there seems all the same to be a very rough concordance between Finnemarka lakes and the lakes in USA and Canada. However, the agreement between Finnemarka lakes, Lake Stugsjön in Sweden (Jansson 1979) and Lake Langtjern in Norway (Henriksen & Wright 1977, Wright & Henriksen 1980) is somewhat confusing. In lake Langtjern the budgets, which are the first for Norway, show that P and Ca outputs slightly exceed inputs, K, Mg and Al are in balance and  $H^+$ , Na,  $SO_4$ , Cl,  $NO_3$  and total C inputs slightly exceeds outputs.

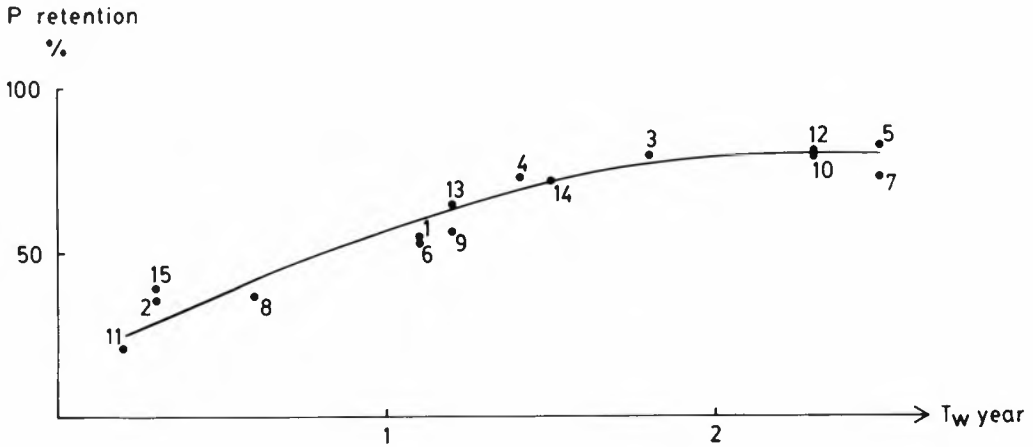

Fig. 87. As Fig. 86, but with retention expressed as %.

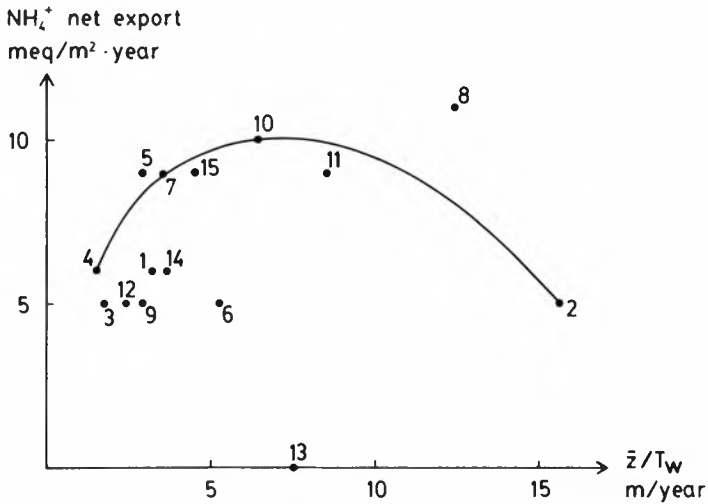

Fig. 88. Net export of ammonia as meq/m<sup>2</sup>·year in the lakes in relation to hydraulic loading. The curve, drawn freehand, describes the hypothetical relation of the plotted values as a basis for discussion.

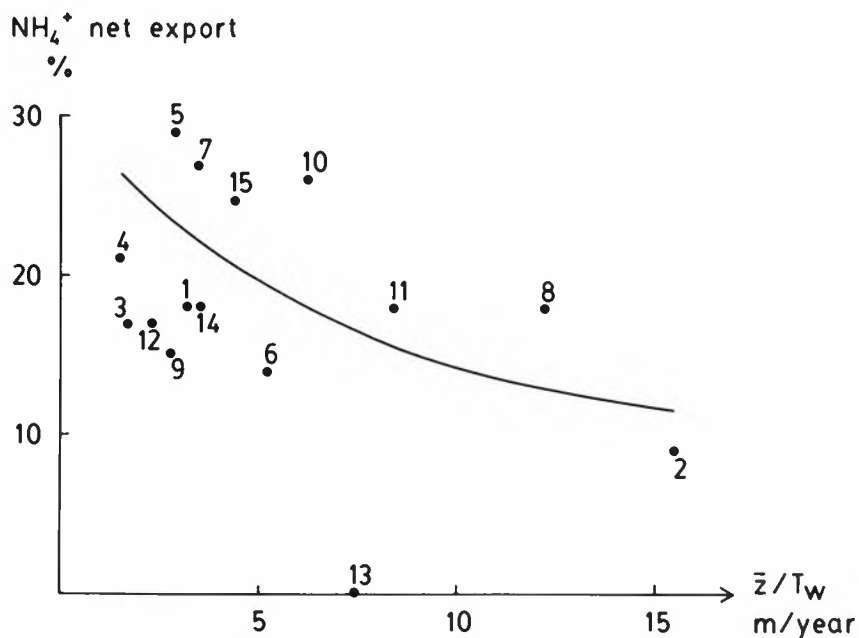

Fig. 89. As Fig. 88, but with retention expressed as %

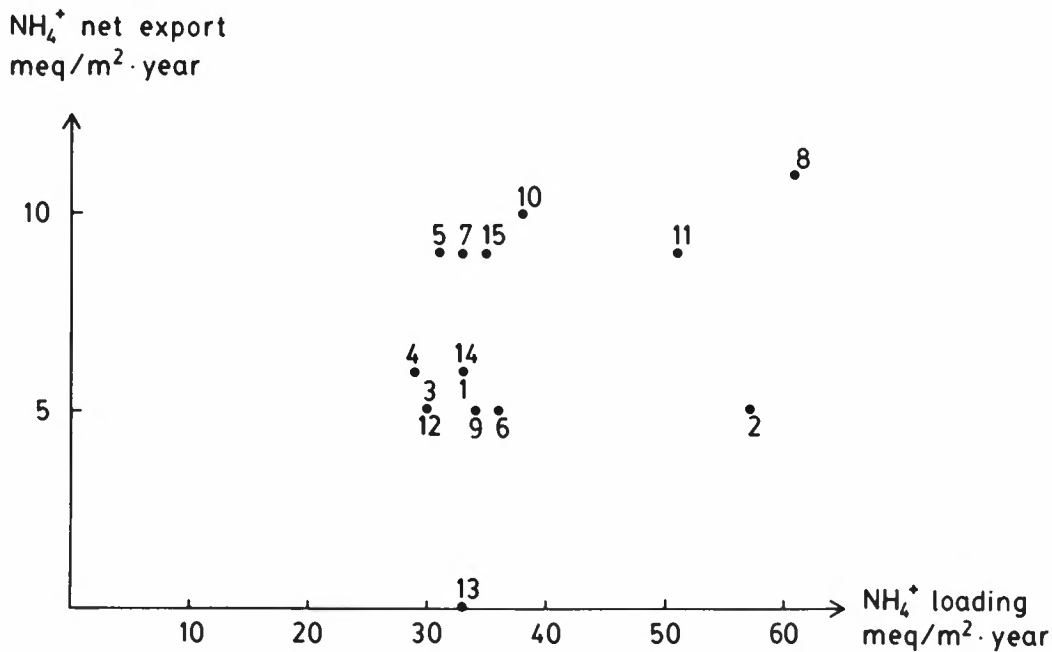

Fig. 90. As Fig. 88, but in relation to ammonia loading and with no «discussion curve».

$\text{NH}_4^+$  net export  
meq/m<sup>2</sup>·year

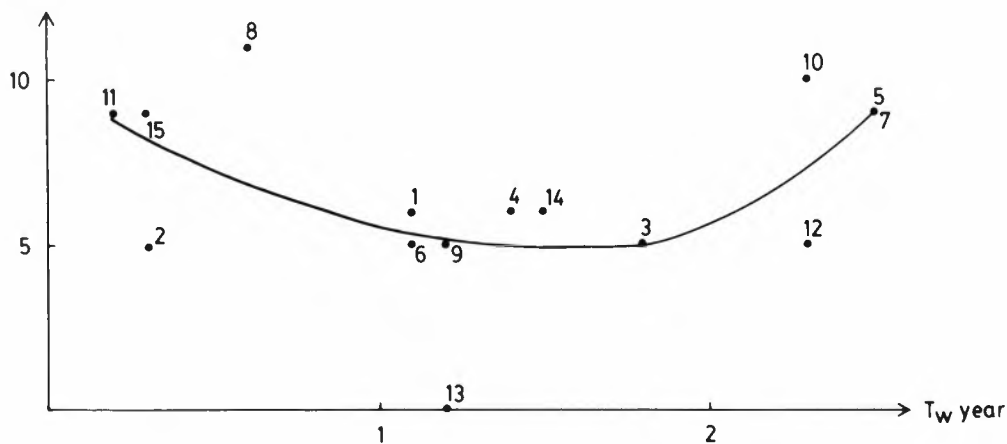

Fig. 91. As Fig. 88, but in relation to hydraulic retention time.

$\text{NH}_4^+$  net export  
%

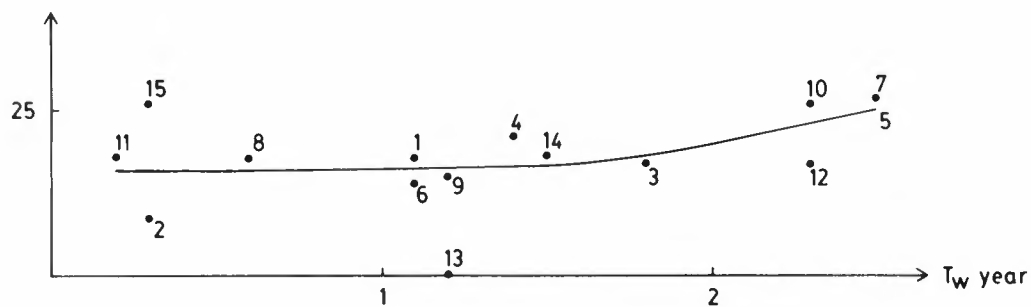

Fig. 92. As Fig. 91, but with retention expressed as %.

Some of the results from Lake Langtjern are difficult to understand, as also pointed out by Wright & Henriksen (1980). To the contrary, the results from the Finnemarka lakes seem generally reasonable. One exception may be the  $\text{NH}_4$  budgets which show a net export. But due to the acid inhibition mentioned and low uptake of  $\text{NH}_4$  by the algae, this phenomenon should be possible. The low uptake of  $\text{NH}_4$  is assumed on the basis of the lakes' oligotrophic nature and relatively high concentrations of  $\text{NO}_3$ . The latter nutrient may be taken up on a level with  $\text{NH}_4$ , and its increase in the precipitation during recent time may possibly have provided for nitrogen not limiting algal growth. This applies primarily to the lakes with low values for  $A_d/A_o$ .

Compared with the thoroughly investigated clear water Lake Gårdsjön in Sweden (Hultberg 1985), the retention values of some components in the Finnemarka lakes seem somewhat high (K, Fe, Al,  $\text{SO}_4$ ) or low ( $\text{NH}_4$ ). This may be connected to higher concentration of humic matter in the last-mentioned lakes. The Humic matter may generally act as a «catalyst» for accumulating components in lake sediments. These components can be adsorbed to humic matter more or less strongly. By deposition and decomposition of the humic matter in the lake sediments,  $\text{NH}_4$  may be released to the lake (see Hongve 1978) and  $\text{SO}_4$  reduced and accumulated as  $\text{FeS}$  ( $\text{FeS}_2$ ) and organic S (see Rudd et al. 1986) in the lake sediments. After having been sedimented together with the humic matter, K and especially Al and Fe are supposed to remain relatively efficiently in the sediments (by adsorption and formation of heavy soluble compounds).

All the retention values in this investigation are of course, as already indicated, characterized by many uncertainties. This is due especially to the fact that these retentions are obtained by calculating differences, with a doubling of the uncertainties. The most common errors existing in this kind of measurement are connected to the diffuse seepage and ground water inputs, determination of the catchment sizes, recording of the discharges and water sampling and quality analyses. However, these factors seem to be relatively moderate due to a clear hydrology, topography and water quality conditions. More exactly, the watershed is relatively clear, the ground water volumes are relatively small, the runoff discharges are relatively easy to determine and the water qualities are relatively steady. These conditions, together with the reasonableness of the results (comparisons with other research work, estimated amounts deposited in the sediments per year and sediment trap measurements treated later in this paper), make these retention values usable for indicating interesting information.

#### *b) General input - output model*

The presented retention data indicate a general picture of the transport and transformation of substances in the lakes. This is illustrated by the model in Fig. 93. This illustration is only a more detailed description of the limnic system previously shown in another model in the introductory chapter (Fig. 3).

The illustration indicates that  $\text{H}^+$ , Ca, Mg, Na, K, Al, Fe, P, organic anions,  $\text{SO}_4$ ,  $\text{NO}_3$  and reactive silicate will be more or less retained annually in the lakes. In contrast, Cl and  $\text{NH}_4$  will be respectively unchanged or net-exported. Bicarbonate, which is an important part of the ions in Lake 13 only, has not been considered regarding the retention in the lakes. Some of the lakes (the «deviation lakes») have also shown values of some few components diverging from the input-output model. However, these disagreements may be regarded as the exceptions confirming the rule.

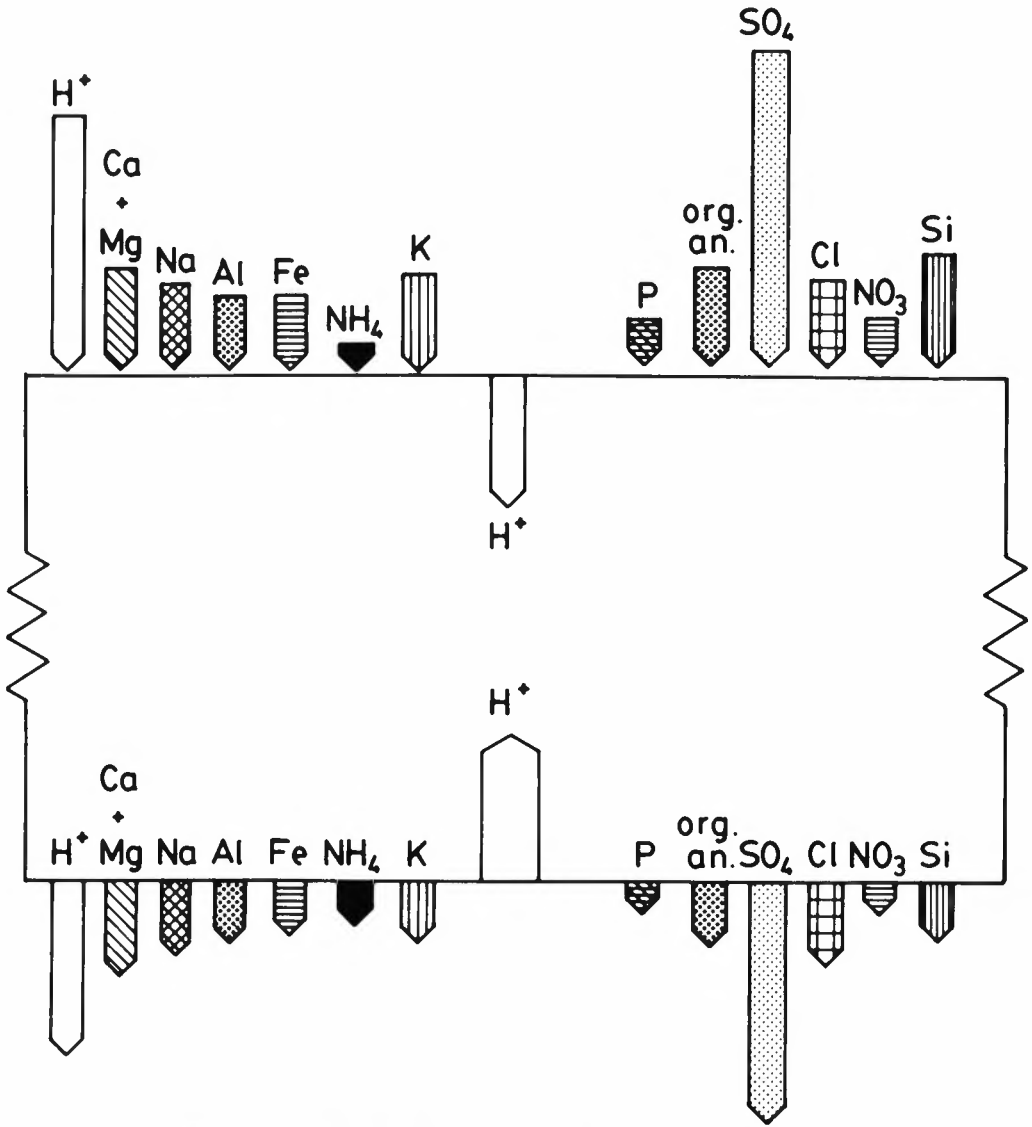

Fig. 93. General input-output model of important components in the lakes. This is a more detailed description of the limnic system previously shown in Fig. 3.

Sedimentation by traps  
g/m<sup>2</sup>·year

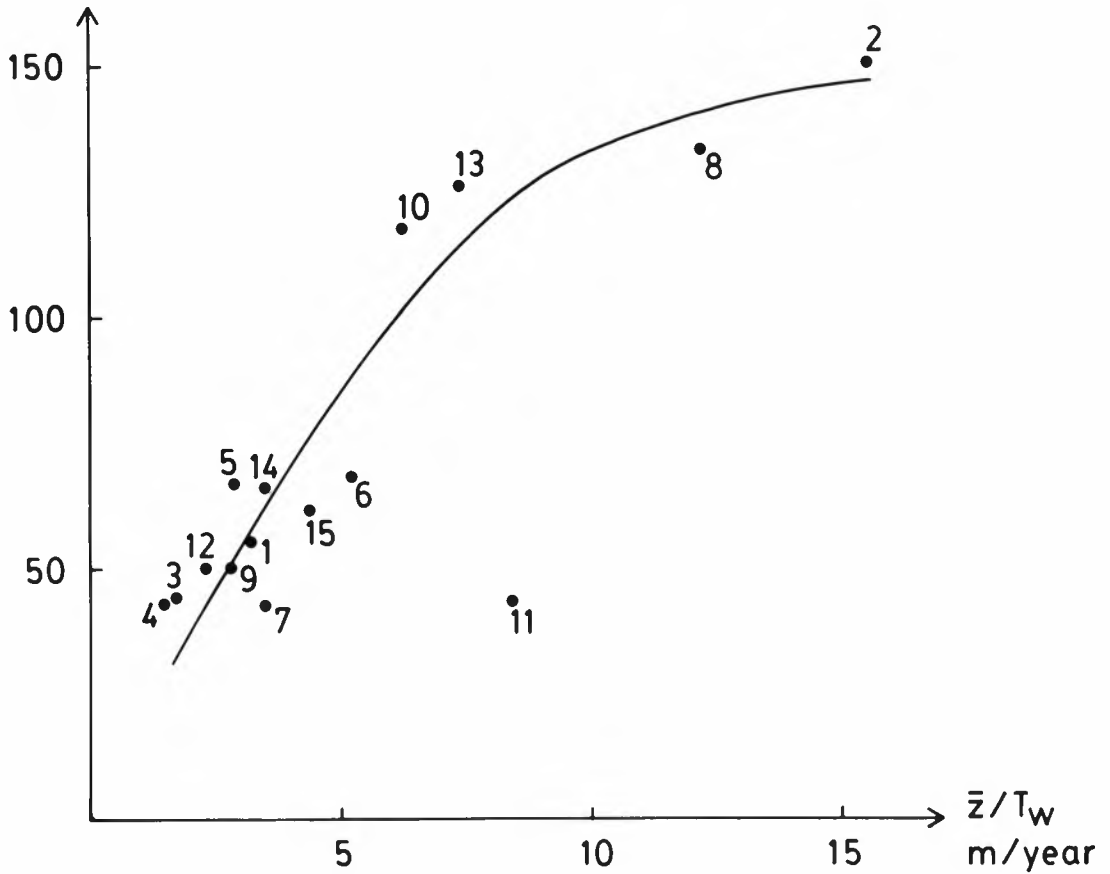

Fig. 94. Sedimentation trap measurements as g dry weight/m<sup>2</sup>·year in the lakes in relation to hydraulic loading. The curve, drawn freehand, describes the hypothetical relation of the plotted values as a basis for discussion.

Sedimentation by traps  
g/m<sup>2</sup> · year

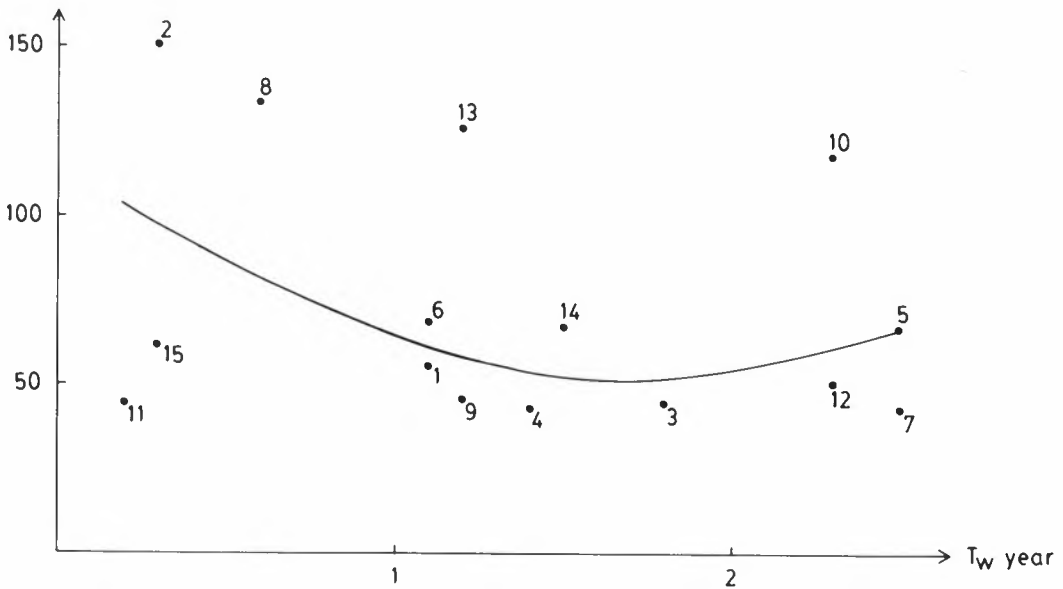

Fig. 95. As Fig. 94, but in relation to hydraulic retention time.

## 2. Sedimentation trap measurements

This is another way to investigate the retention of substances in the lakes. The measurements are direct and do not therefore double the uncertainties as in the input-output measurements. On the other hand, there are some other uncertainties with trap measurements (Bloesch & Burns 1980, Sanni et al. 1984). The substances which were collected in the traps cannot be considered identical to the substances remaining in the lake sediments without reservations. This is due to difficulties in establishing representative trap stations and the possibilities for resuspending and redissolving the substances.

Sedimentation trap measurements in relatively small, humic-influenced lakes, more or less acid, have not been extensively carried out as far as the author knows. But some investigations have been performed on large oligotrophic lakes (Thomas 1955, Penington 1974, Bjerke et al. 1977, Abrahamsen et al. 1983) and mesotrophic and eutrophic/hypertrophic lakes of different sizes (Reissinger 1932, Bloesch 1974, Hongve 1978, Skogheim 1980, Mothes 1981, Premazzi & Marengo 1982). However, a comparison between these lakes and the Finnemarca lakes is not possible without strong reservations.



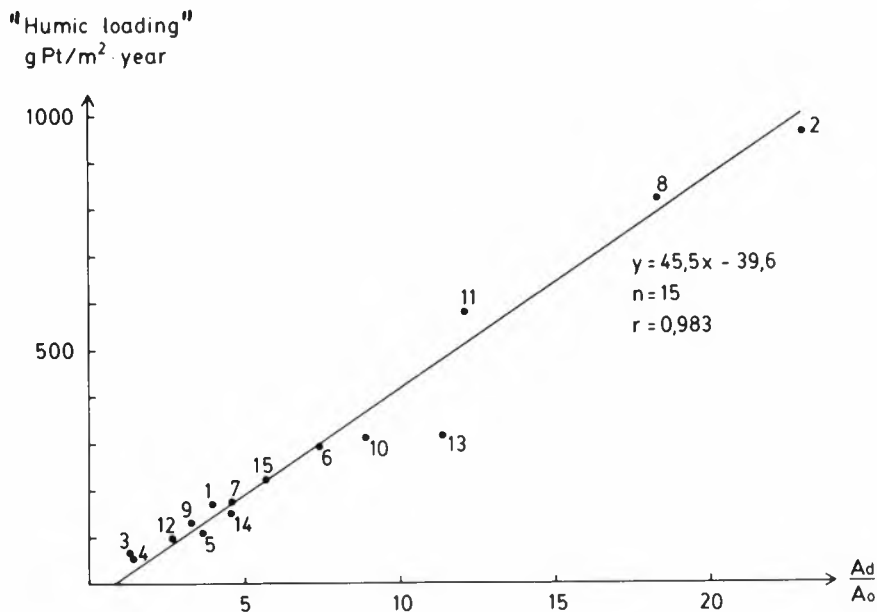

Fig. 96. «Humic loading» as g Pt/m<sup>2</sup> year of the lakes in relation to the terrestrial catchment - lake area ratio. The line describes the regression.

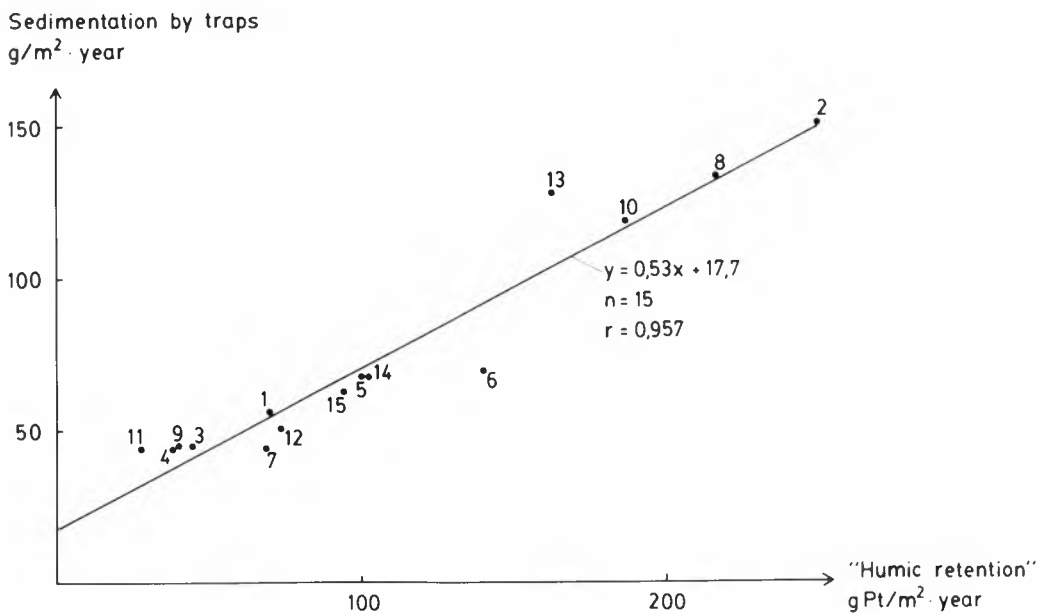

Fig. 97. Sedimentation trap measurements as g dry weight/m<sup>2</sup>·year in the lakes in relation to «humic retention» as g Pt/m<sup>2</sup>·year. The line describes the regression.

Sedimentation by traps  
g/m<sup>2</sup> · year

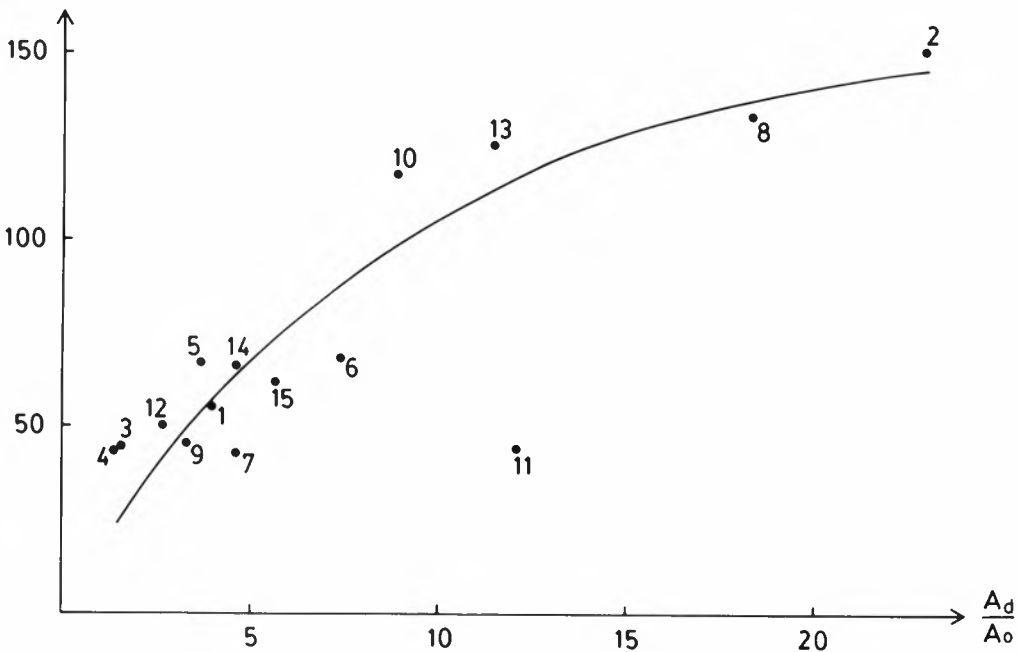

Fig. 98. Sedimentation trap measurements as dry weight/m<sup>2</sup>·year in the lakes in relation to the terrestrial catchment - lake area ratio. The curve, drawn freehand, describes the hypothetical relation of the plotted values as a basis for discussion.

*a) Trap measurements in relation to hydraulic loading and retention time*

The diagrams are shown in Figs. 94 and 95. The discussion curves have the same meaning as previously mentioned. These curves and the patterns of the plotted lakes roughly resemble many of the diagrams showing the retention of different substances, e.g. «humic retention» and retention of reactive silicate (Figs. 53, 56, 73 and 76). This fact indicates that the trap values are of reasonable magnitude, at least relatively. Comparison to the recent sedimentation (permanent deposition), based on sediment analyses and estimated sedimentation rates, further confirms the trap data as acceptable.

*b) Trap measurements in relation to the ratio of terrestrial catchment to lake area*

From a rational point of view, there should be a connection between the ratio  $A_d/A_o$  and the trap values as amount per lake surface area. This is based on the facts that the main amount of sedimenting substances in the investigated lakes is contributed by the terrestrial catchment and that this contribution is proportional to the size of the area which the runoff water drains. The size of the deposition area (lake area) will, of course, also be of decisive importance for the final sedimentation amount (rate) per

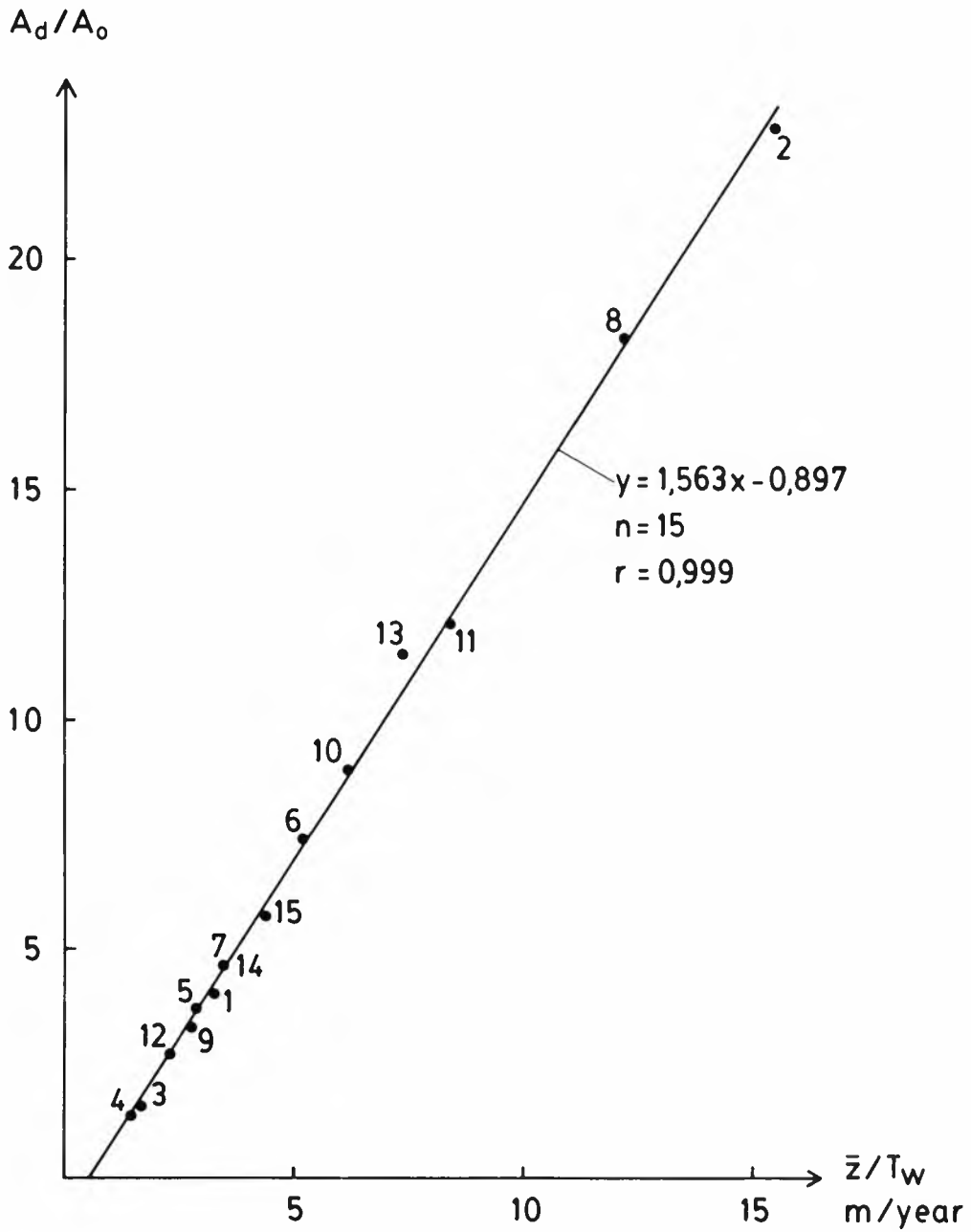

Fig. 99. The terrestrial catchment - lake area ratio of the lake in relation to hydraulic loading.

Sedimentation by traps  
g/m<sup>2</sup> · year

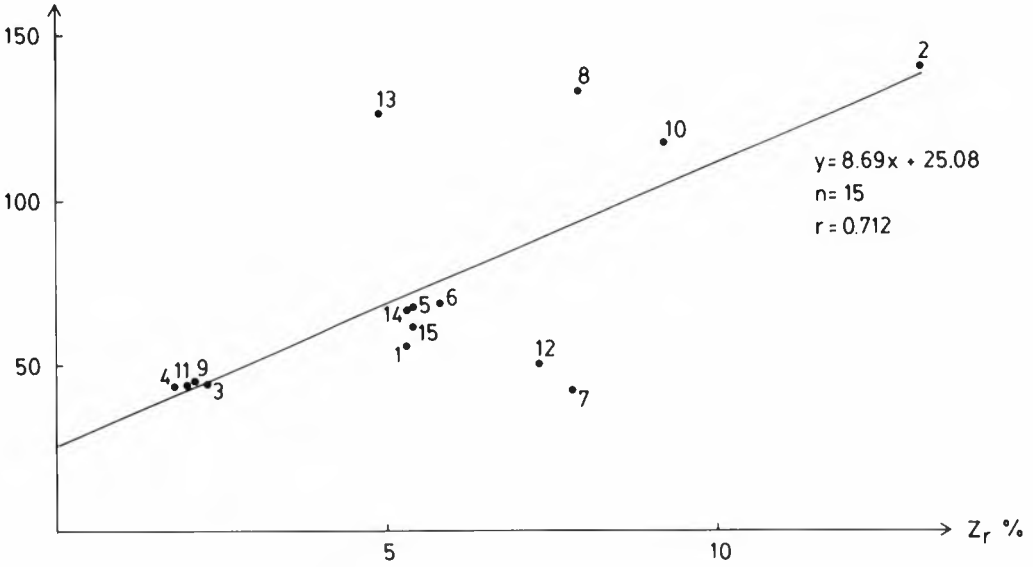

Fig. 100. Sedimentation trap measurement in the lakes in relation to relative depth. The line describes the regression.

Sedimentation by traps  
g/m<sup>2</sup> · year

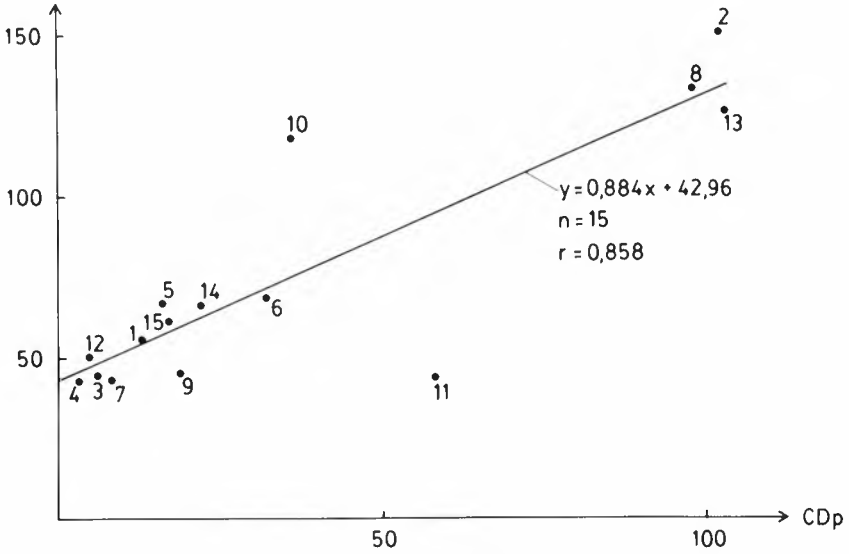

Fig. 101. As Fig. 100, but in relation to catchment's drainage potential.

surface area. This has been elucidated by plotting the relation between «humic loading» and  $A_d/A_o$  (Fig. 96). The correlation is high and confirms the above-indicated relationship. Lake 13, which lies partly in more calcareous rocks and loose deposits than the other lakes, reduces the correlation coefficient significantly with its relatively low «humic loading». It is also worth mentioning that Lake 11, which has the highest density of bogs, is located above the regression line. The relation of the sedimentation trap values to the «humic retention» is presented in Fig. 97 and is, together with Figs. 55 and 96, an additional indication of the importance of the size of the terrestrial catchment in relation to the size of the lake surface, regarding the trap data.

The correlation between the «humic loading» and  $A_d/A_o$  (Fig. 96) is of special interest regarding the question about the amount and quality of the seepage and ground water supply to the lakes. If the amounts of humic matter in the catchments are equal (for instance in the sense of bog percentage) a good correlation should indicate small quantities of unsampled seepage and ground water flow to the lakes. This water are normally less coloured than the drainage water. With regard to the equality of humic matter in the catchments, only Lake 11 has a higher and Lake 13 a lower percentage of bogs than the other lakes. Their position in relation to the regression line in Fig 96 seem therefore reasonable. Lake 10, which is assumed to receive a discernable amount of ground water, has its position below the regression line. In this connection it could be mentioned that Lake 5 is also lying on the right side of the regression line.

On basis of the above-mentioned facts, and the good correlation of the data in Fig 96, it seems reasonably to consider the water sampling in the catchments as usable.

Finally the connection between the trap data and  $A_d/A_o$  is shown in Fig. 98. This diagram with its discussion curve is much like that of  $Z/T_w$ , as already presented in Fig. 94. This great similarity has made it interesting when plotting  $A_d/A_o$  in relation to  $Z/T_w$ . This is shown in Fig. 99 and reveals a very high correlation for the lakes investigated. This means that, if necessary, it is possible to calculate one of the four parameters ( $A_d$ ,  $A_o$ ,  $Z$ ,  $T_w$ ) by using the regression equation given in the figure.

*c) Trap measurements in relation to relative depth and catchment drainage potential*

The trap values are shown in relation to  $Z_r$  in Fig. 100. The correlation is of importance considering the many additional factors which determine the trap values. First of all, there are Lakes 7 and 12, which deviate from the regression line by relatively small trap values, and Lakes 8 and 13, with relatively high trap values. Lakes 7 and 13 have been previously characterized as deviation lakes, and this may explain the relatively low and high trap values respectively. The two other lakes mentioned are not easy to discuss in this connection.

In Fig. 101 the trap data are plotted against CDp. The correlation is of significance, especially taking into consideration that only two lakes deviate relatively much from the regression line. These two lakes are either very deep (Lake 10) or very shallow (Lake 11), which may explain the high and low trap values respectively.

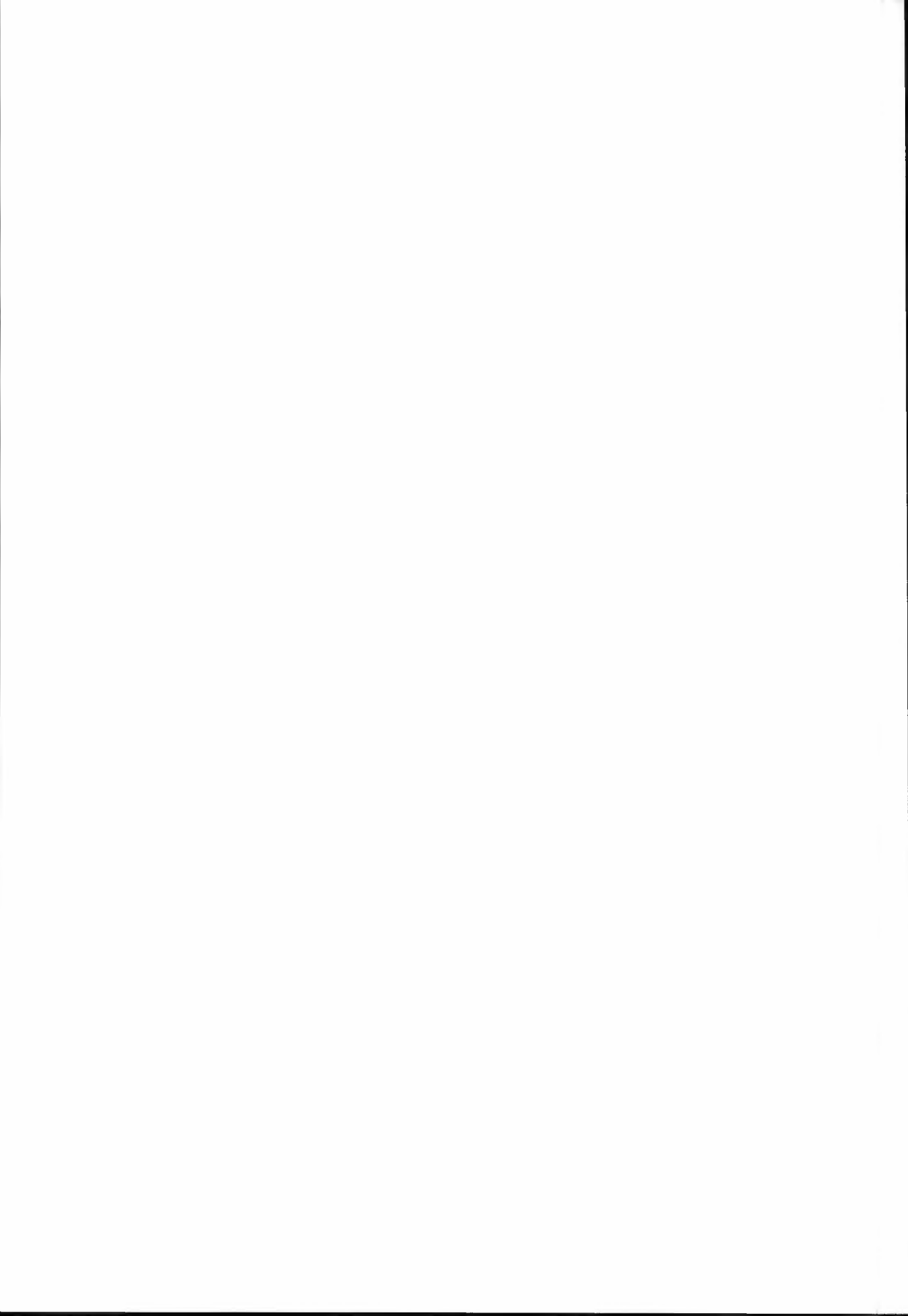

## VIII. LAKE SEDIMENT ANALYSES

This is another source of information about the lakes' retention of substances. In addition, sediment analysis is a well known method of paleolimnological investigation. The research on lake sediments during the last years has been extensive (e.g. Mackereth 1966, Kjensmo 1968, 1978, Bengtsson & Fleischer 1971, Gorham & Sanger 1972, Stockner 1972, Frey 1974, Bøyum 1976, Skogheim 1976, 1978, Skogheim & Erlandsen 1984, Håkanson 1981, Brown et al. 1984, Smol et al. 1984, Baas & Boucherle 1984, Bryon & Eloranta 1984, O'Sullivan et al. 1984, Segerström et al. 1984, Simola et al. 1984). In connection with acidification the following papers can also be mentioned: Davis & Berge (1980), Renberg & Hedberg (1982), Dickman & Fortescue (1984), Brakke (1984), Norton & Hess (1980), Andersson ((1985), Renberg (1985), Charles & Norton (1986).

An important aim of these sediment analyses has been to investigate the change in the lakes during the acidification period. This change, if reflected in the sediments, can become as one piece of the difficult jig-saw puzzle called lake acidification.

### 1. Sedimentation rates recorded by sand marking and lead analyses

The sedimentation rates are crucial for interpretation of the sediment analyses. These rates can be determined by dating the different strata of the sediments, but this is not always easy. Several methods are, however, available: 1. Counting of varved, or annually laminated, sediments (Renberg 1981, Segerström et al. 1984). 2. Radiological analyses.  $^{137}\text{Cs}$ ,  $^{210}\text{Pb}$  and  $^{14}\text{C}$  have been used (Kjensmo 1978, Skogheim & Erlandsen 1984),  $^{137}\text{Cs}$  for the recent sediments and  $^{14}\text{C}$  for the sediments older than 2-400 years. 3. Sediment recordings of known phenomena in the catchments (e.g. heavy soil erosion, forest fires). 4. Artificial marking in the sediments preceding core sampling.

Methods 3 and 4 have been used in this investigation. Radiological dating with  $^{137}\text{Cs}$ , mentioned under point 2, has been tried unsuccessfully and dating with  $^{210}\text{Pb}$  was found too expensive. However, as early as 1972, the idea emerged of supplying the sediments with sand for later use in the sedimentation rate measurements. In lakes 3, 5, 8 and 13, sand was poured into the ice holes and the sediment cores were sampled in the winter of 1982. The location of the sand layers in the sediments was determined by taking cross bearings and measuring the distance from fixed points on land. In spite of these arrangements, it was not easy to find the sediments with the sand layers. About 10 sediment cores in each of the four lakes were taken before satisfactory results were obtained. The analyses of the sediments gave the following annual sedimentation rates: Lake 3: 1.0 mm, Lake 5: 1.5 mm, Lake 8: 3.0 mm and Lake 13: 2.5 mm.

In the catchment of Lake 13, the time of the building of the road along the lake shore (see Fig. 9) has been used to date the uppermost sediment layer by lead analyses. These analyses have given a somewhat lower sedimentation rate (about 2 mm/yr) than given by the sand marking method, but the order of magnitude is the same. This results, together with the possibility for the sand particles to move downwards into the sediments, indicate that the measured sedimentation rates may be somewhat too high. 2.5 mm/yr. was nevertheless used to provide equal treatment when estimating the year of the sediment strata in Lake 13 (Fig. 115).

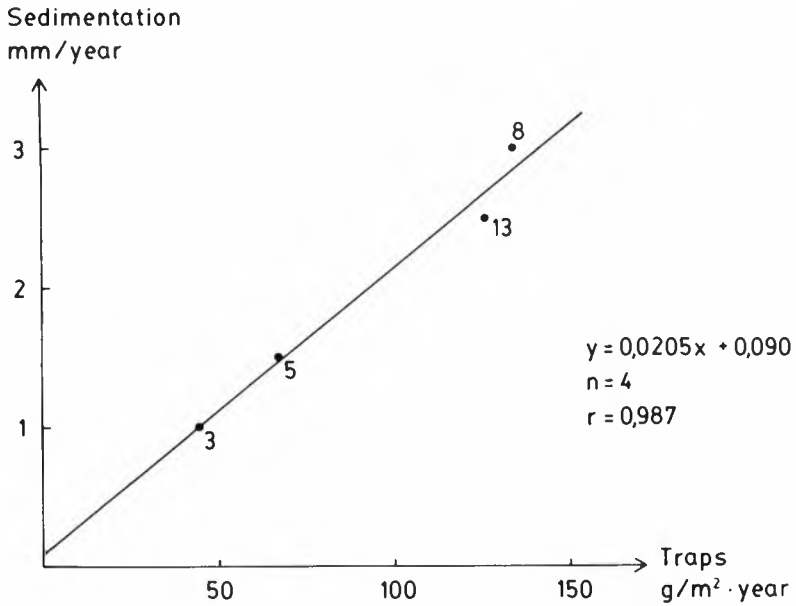

Fig. 102. Recent sedimentation rates as mm/year in four lakes, measured by sand mark dating of the sediments, in relation to sedimentation trap measurements.

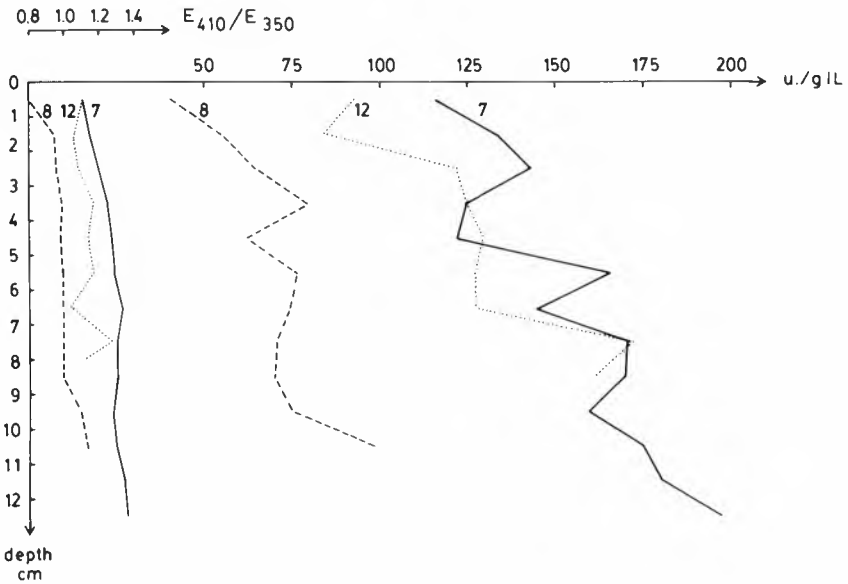

Fig. 103. Sedimentary chlorophyll determinations as units/g ignition loss and the ratio between light extinctions at wavelengths 410 and 350 nm, measured on the acetone-extracts, of sediments from three lakes.



## 2. Sedimentation rates calculated by sedimentation trap measurements and sediment dating by sand marking

The sedimentation rates, measured by the sand mark dating, were plotted against the sedimentation trap measurements, as shown in Fig. 102. The correlation is good and the regression line in the figure has consequently been used to calculate the sedimentation rates in the other undated lakes. These results are presented as estimated year, in the same figures as the depth distribution of the different chemical parameters (Figs. 106-116). The great uncertainty connected to these measured and calculated sedimentation rates (probably too high values) makes it necessary to consider the estimated year as very rough, especially at greater sediment depth where the consolidation is better and the water content somewhat smaller.

## 3. Determination of sedimentary chlorophyll and the ratio $E_{410}/E_{350}$

The concentration of chlorophyll degradation products in the sediments, expressed as units per weight total organic matter (in this paper measured as ignition loss), has proved to be an indication of trophic conditions in the lakes. This applies both to a comparison of the surface sediment content with appropriate parameters in the water and to a comparison of the chlorophyll content of Late- and Post-glacial sediments with some other productivity indications (Gorham 1960, 1961, Wetzel 1970, Sanger & Gorham 1972, Gorham et al. 1974, Gulbrandsen 1980, Skogheim 1976, Skogheim & Erlandsen 1984). However, the concentrations of sedimentary chlorophyll are also determined by the preservation conditions, i.e. by temperature, light and oxygen (Gorham & Sanger 1972, Gulbrandsen 1980). By expressing the concentration of the chlorophyll degradation products per unit ignition loss, the effect of the inorganic sedimentation is excluded and the parameter could be apparently used directly as a measure of productivity variation. However, this requires good information about the sedimentation rates, which again requires sediment dating of high accuracy. This is due to the fact that allochthonous organic matter contains less chlorophyll degradation products than autochthonous organic matter (Gorham & Sanger 1964, 1967, Gulbrandsen 1980). The sediment dating in this research is unfortunately too rough for clear interpretation of the data, but some indications can be made.

The pigment ratios ( $E_{410}/E_{350}$ ) will, on account of the above mentioned facts, also be important as a rough indicator only. Gorham (1961) has suggested that the ratio in question rises with increasing lake fertility, and this has been later investigated and discussed by Gulbrandsen (1980).

Only nine lakes (Lakes 3, 4, 5, 6, 7, 8, 10, 12 and 13) in Finnemarka and one of the reference lakes (Lake Haukevannet) have been analysed, for economic and capacity reasons. The data are presented in Figs. 103, 104 and 105. Due to the interpretation difficulties already pointed out, only trends will be discussed. Lakes 7, 8 and 12 show increasing values with increasing sediment depth (Fig. 103). The lakes in Fig. 104 (Nos. 3, 4, 5 and 10) also show increasing values with depth, but the trend is less pronounced than for the lakes shown in Fig. 103. Fig. 105 shows the lakes (Nos. 6, 13 and the reference lake) with very small or no trend from the sediment surface and downwards. These findings give reason to believe that productivity in the last-mentioned lakes has not changed significantly in recent time. In this connection it could be mentioned that Lake 13 has probably always had a neutral pH, Lake 6 has possibly been relatively acid for a long time (perhaps before 1900, according to fish observations by elderly local people), and Lake Haukevannet (the reference lake) is

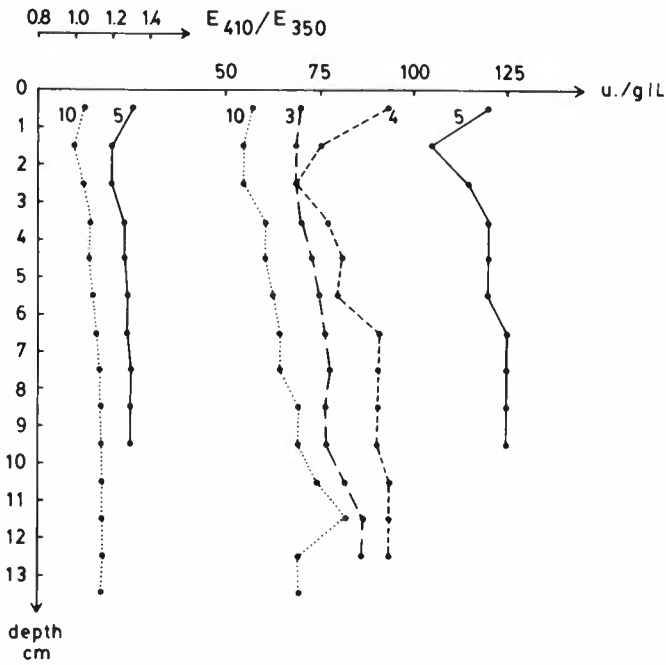

Fig. 104. As Fig. 103, but for four other lakes. The wavelength ratio has been measured in two of the lakes only.

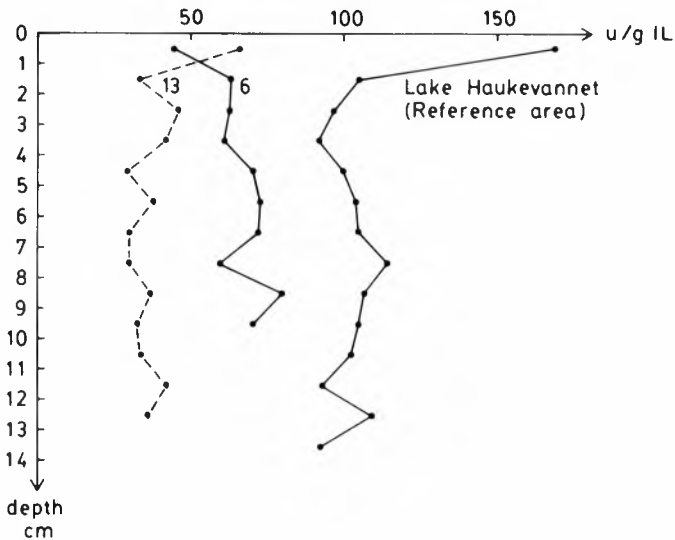

Fig. 105. As Fig. 103, but for three other lakes (one of these is a reference lake). The wavelength ratio has not been measured.

supposed to have had a pH around 6.0-7.0 for a relatively long time, all of which may partly explain the recordings of the sedimentary chlorophyll in these lakes.

Some lakes show a marked increase of the sedimentary chlorophyll in the top layers of the sediments. This may be connected to newly produced chlorophyll in the lake water.

Considering the pigment ratio  $E_{410}/E_{350}$ , the weak increase with sediment depth may support the oligotrophic development of the lakes during recent time.

The question is then, what is the reason for this possible development? It is not easy to give an exact answer, but some possibilities can be put forward: 1. The cessation of waste products from cattle grazing and the connected human activities may have decreased the nutrient supply to the lake (especially the algal-available P). 2. Nutrients (P) may have been absorbed by the changed vegetation in the catchments. 3. Acidification may have made the nutrients (P) in the lakes less available for algal growth (see Grahn et al. 1974, Anderson et al. 1978, Andersson & Gahnström 1985, Stenson 1985). 4. Acidification may have produced algal toxic components, e.g. Al (Hørnstrøm & Ekstrøm 1983, Stenson 1985).

In the catchment of the reference lake, the cattle grazing has not completely ceased (but is somewhat reduced), in contrast to around the Finnemarka lakes. This phenomenon, together with the more neutral lake pH, may explain the steadier state of the trophic status of the reference lake. Lakes 6 and 13 may also be considered as relatively steady regarding the trophic status, due to the same arguments used in the discussion of the distribution of sedimentary chlorophyll. Many scientists believe that the lack of nutrients, and not the acidity per se, is the main cause of the low productivity in acidified lakes (Grahn et al. 1974, Dillon et al. 1979, DeCosta & Preston 1980, Hørnstrøm & Ekstrøm 1983, Lyden & Grahn 1985).

#### **4. Determination of $H_2O$ , IL (organic matter), pH, $E_h$ , N, S, Al, Fe, Mn, Ca, P, Si, (alkaline-soluble), N/S and IL/N**

For reasons of capacity and economy, it has not been possible to do chemical analyses of the sediments from all the investigated lakes in Finnemarka. Furthermore, some of the lakes' sediment cores have been cut into slices of relatively great thickness (1-3 cm) to reduce the laboratory work.

Ignition loss (IL) has been used instead of carbon analysis for practical reasons (lack of advanced equipment at the laboratory). E. g. Gulbrandsen (1980) has shown a high correlation between IL and C, which supports using IL as a measure of organic matter. By mistake, the alkaline soluble silicate was analysed somewhat differently than intended. The intention was to analyse for amorphous silicate, which should have been a measure of biologically formed silicon (Tessenow 1975). But it is assumed that the fraction analysed nonetheless can be a rough indication of the amount of diatoms having been sedimented during recent time.

Generally, interpretation of the sediment data is difficult, as the sediments have been affected by several processes since formation. This applies especially to  $E_h$ , pH, IL and the components involved in redox reactions (e.g. Fe and Mn).

The chemistry of a particular vertical increment of sediment is determined by the following (Charles & Norton 1986): 1. The chemistry of the material supplied by the

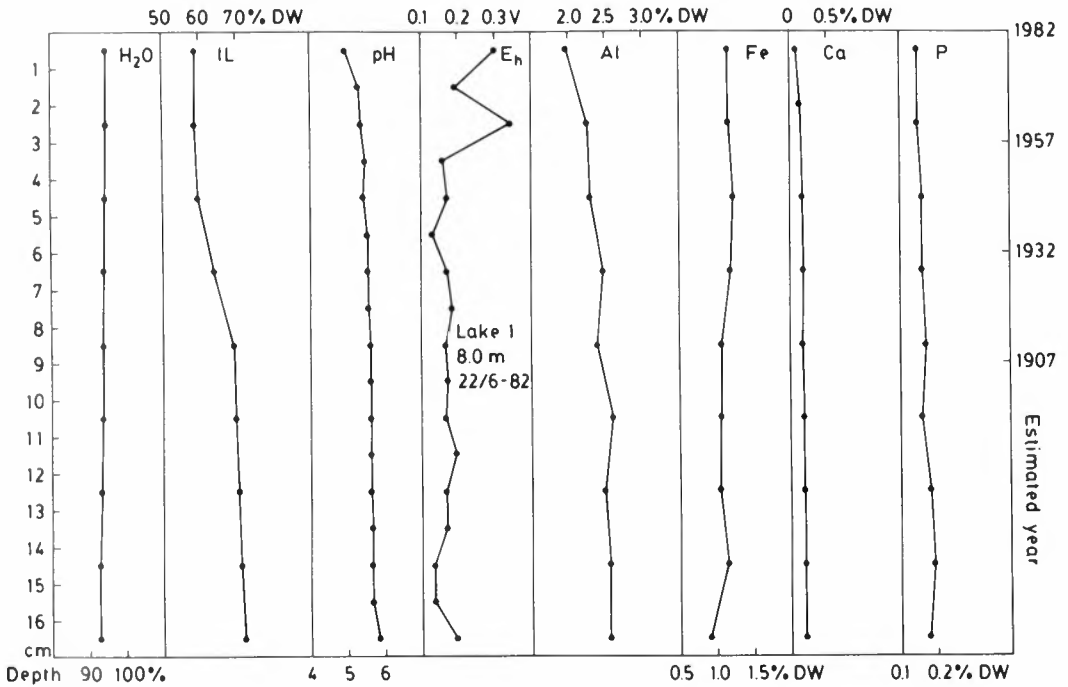

Fig. 106. Sediment analyses from Lake 1.

deposition from the atmosphere and erosion from the drainage basin. Some of this material may be resuspended from other parts of the lake and deposited at the sampling site. Redeposited sediment places older material with possibly different characteristics in a younger interval. 2. Net sedimentation of material derived from within the lake. This material includes organisms and resuspended sediment. 3. Additions to, losses from, or relocation of inorganic and organic substances within the sediment after deposition. Generally, these changes are greatest at the sediment-water interface in oligotrophic lakes and decrease rapidly to steady state at depths of 5-10 cm.

*a) The Finnmarka lakes.*

**L a k e 1.**

The sediment data are presented in Fig. 106. Not all the parameters referred to in the heading have been analysed in this lake's sediments.

The data show small variations during this period which has been estimated to be 100-150 years. Roughly speaking, the parameter values could be characterized as follows: H<sub>2</sub>O: 92-95 %, IL: 60-70 %, pH: 5-6, E<sub>h</sub>: 0.1-0.3 volts, Al: 2.0-3.0 % DW, Fe: 1.0-1.5 % DW, Ca: 0.1-0.2 % DW and P: 0.15-0.2 % DW. In spite of the small variations in the data, a very weak trend could be described. The values of Fe and Eh decrease with sediment depth, while those of Al, Ca, P, pH and IL, on the other hand, increase.

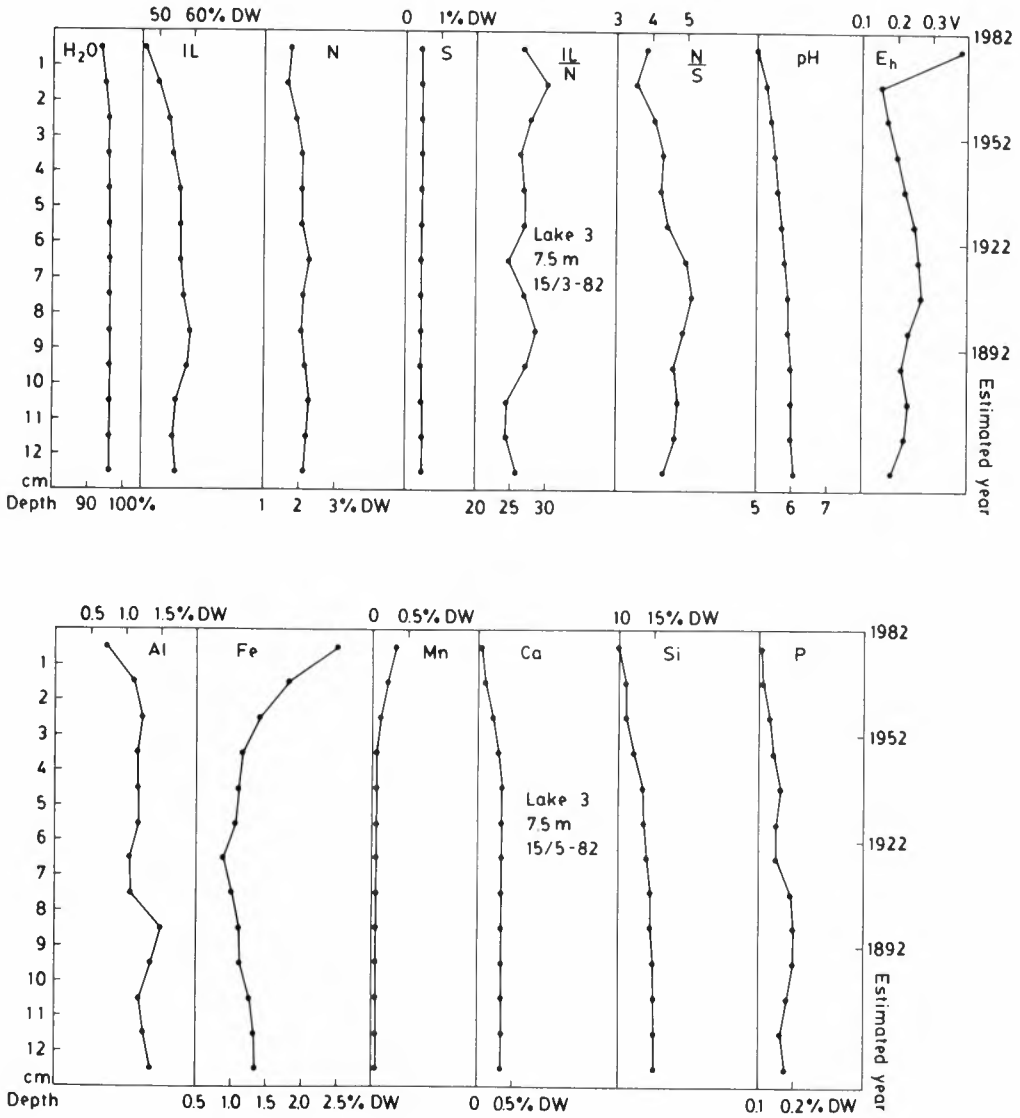

Fig. 107. Sediment analyses from Lake 3.

### L a k e 3.

The data are shown in Fig. 107 and indicate the same trend for some of the parameters as pointed out for Lake 1. This applies to IL, pH, Al, Ca, P (increase downwards) and Fe (decreases downwards). The parameter values are roughly of the same order of magnitude as for Lake 1. Mn, which was not analysed in Lake 1, decreases downwards.

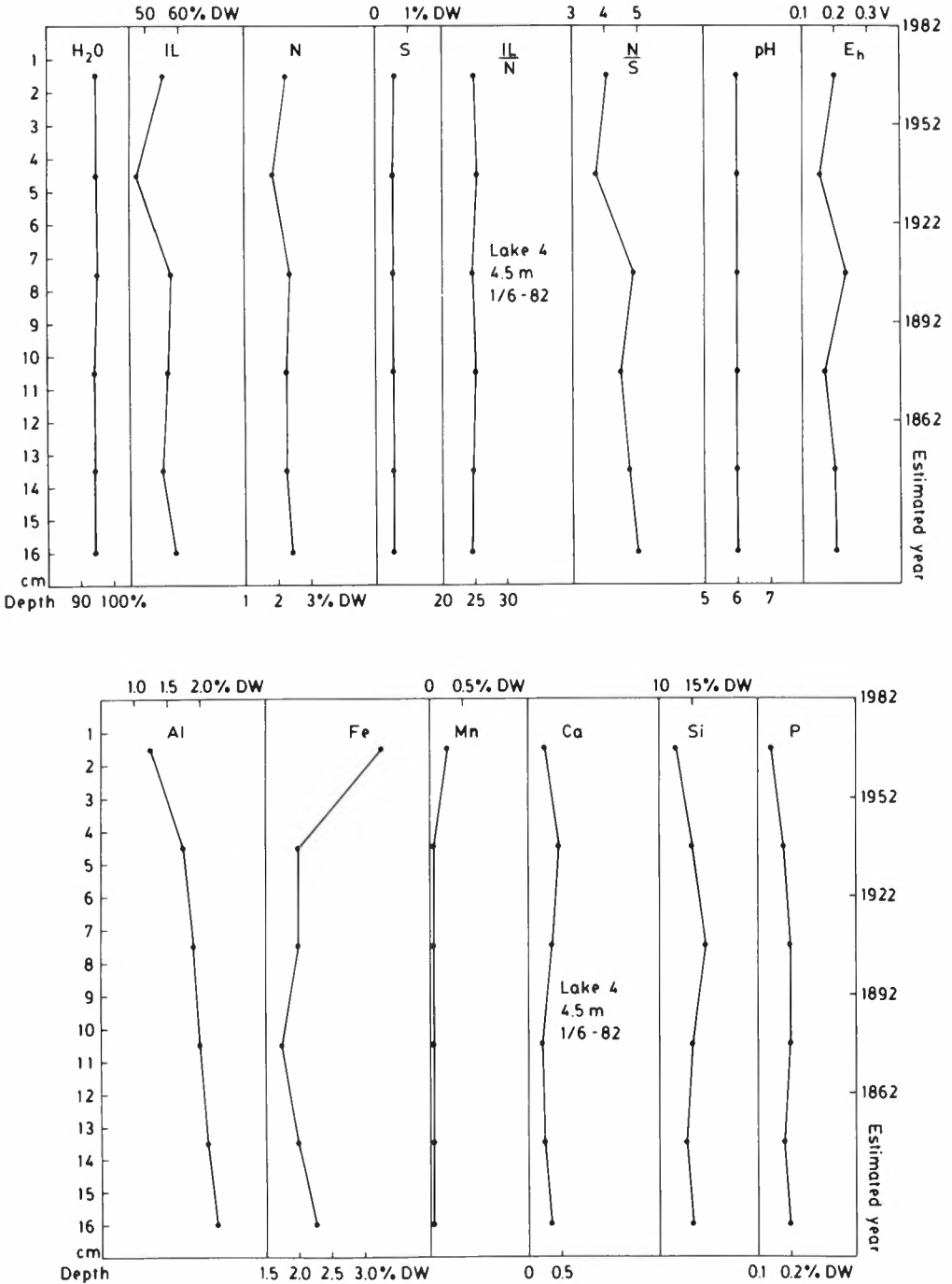

Fig. 108. Sediment analyses from Lake 4.

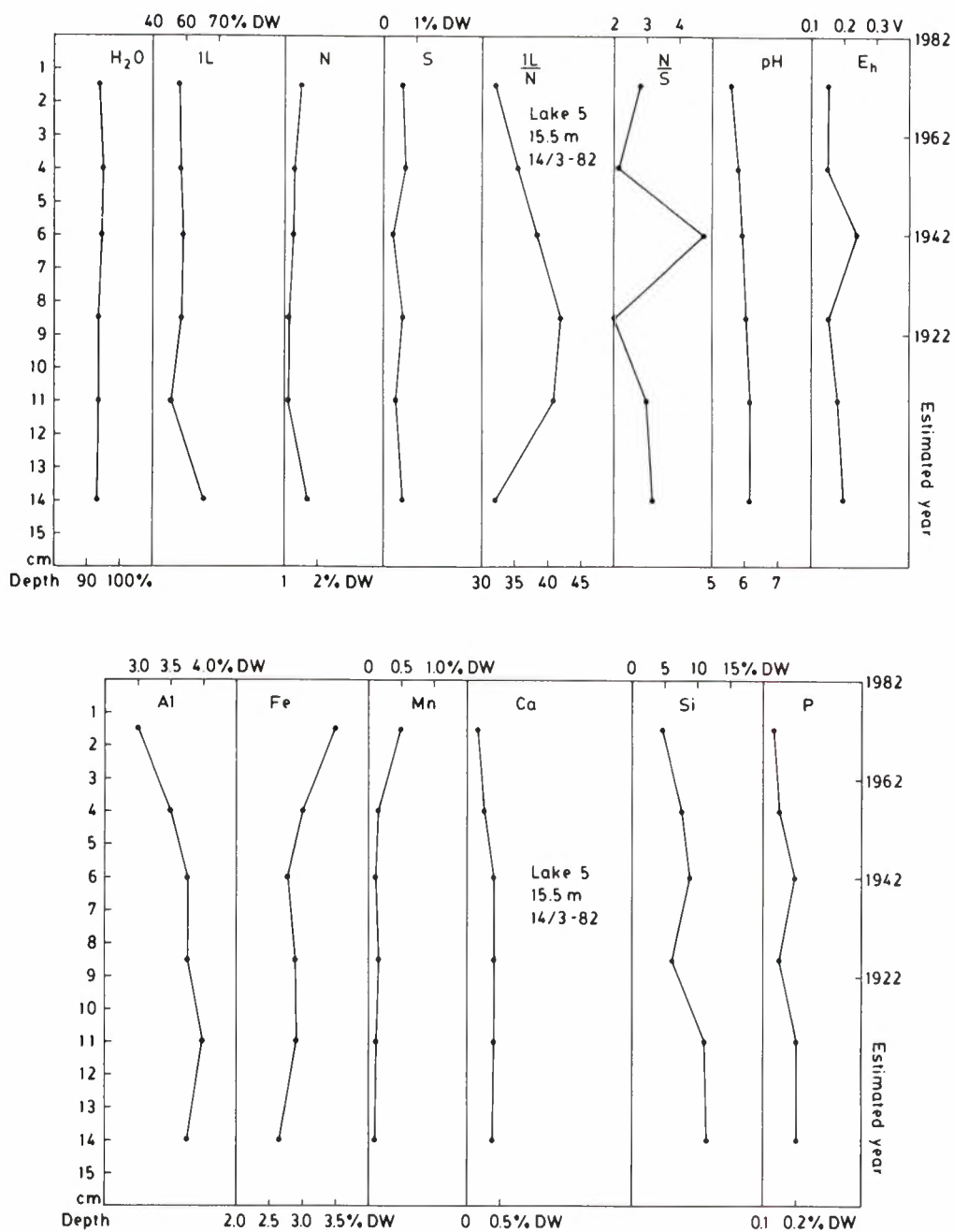

Fig. 109. Sediment analyses from Lake 5.

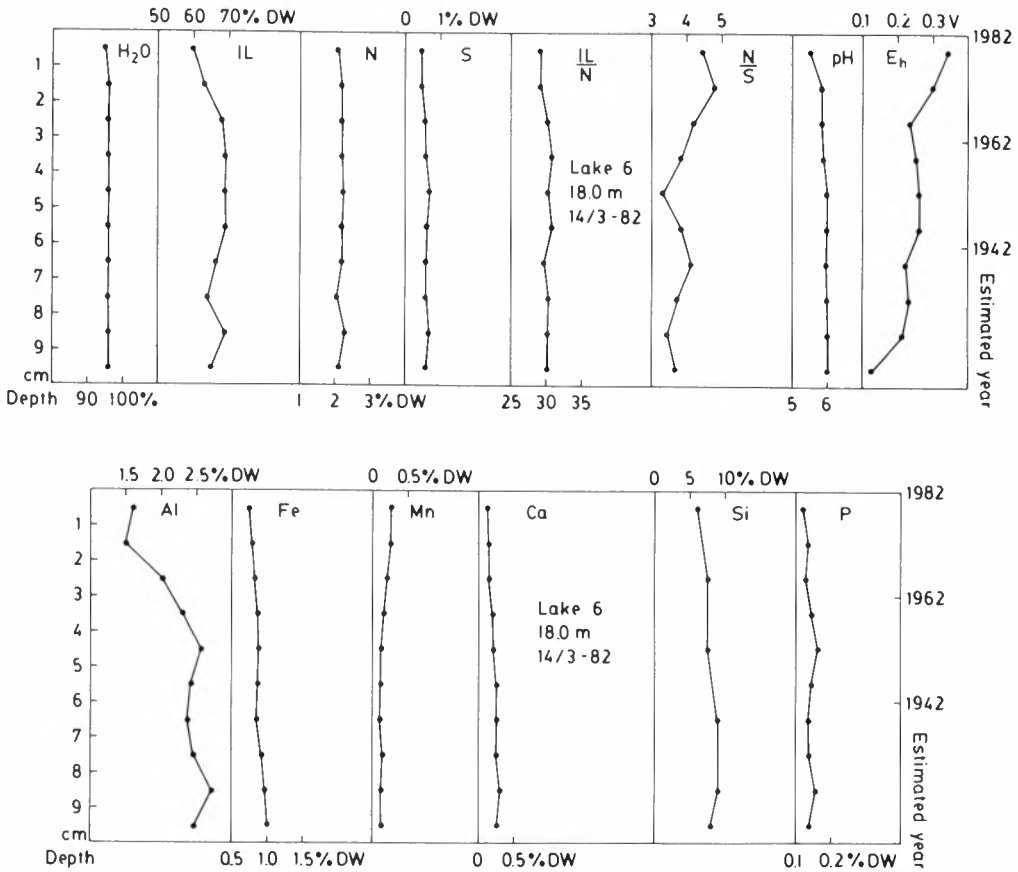

Fig. 110. Sediment analyses from Lake 6.

$E_h$  shows an irregular distribution downwards and the pattern is much like that of the ratio  $N/S$ . This ratio may indicate the amount and changes of inorganic sulphur deposited in the sediments (Ødelien et al. 1973, Selmer-Olsen 1981). If the inorganic sulphur deposited is a result of sulphate reduction to sulphide, the resemblance between the  $E_h$  and  $N/S$  variations seems reasonable, although the  $E_h$  values recorded at present in the sediments are too high for the sulphide reduction process ( $E_7 < 0.1$  volt). It could be of interest in this connection to mention that Rudd et al. (1986) have shown transformation of reduced sulphate to organic S in a long term accumulation in lake sediments. Nitrogen (N) increases and sulphur (S) is roughly unchanged downwards. The N increase may be connected to the increase in IL (organic matter). The ratio  $IL/N$  is nearly the same as  $C/N$  if the IL value is multiplied by 0.5 (Mackereth 1966, Gulbrandsen 1980). This ratio indicates the content of allochthonous versus autochthonous organic matter (Hansen 1962, Wetzel 1975, Gulbrandsen 1980, Erlandsen & Skogheim 1984). Wetzel mentions that soluble allochthonous organic matter in general contains a  $C/N$  ratio of 45-50 and soluble autochthonous a ratio of 12. Erlandsen and Skogheim (1984) report a ratio of 10 for the profundal sediments in



Lake Steinsfjorden (eutrophic) and up to 20 for the more oligotrophic Lake Tyrifjorden. The IL/N ratio in the sediments of Lake 3 is 24-28 which again corresponds to about 12-14 for the C/N ratio. This indicates a certain influence of allochthonous organic matter on the lake. However, the variation with sediment depth seems too small and unsystematic to permit a change in this ratio in the lake history. The alkaline soluble silicate (Si) increases with increased sediment depth and may indicate a higher concentration and productivity of diatoms in the lake in previous times. The contemporaneous increase in P and IL seems to corroborate this statement. However, it is important to keep in mind that Si and P may have been coupled to the humic matter (IL), thus explaining the decreased deposition of late years by decreased supply from the terrestrial catchment.

#### L a k e 4.

This lake is much like Lake 3 in many respects. The clearest difference is manifested through liming and fish cultivation and some other activities occurring in Lake 4 (there are 7 vacation cottages in the small catchment and the lake is a relatively central place for touring). Lake 3 has only one cottage (very little used) and the touring activity is minimal. Both lakes were more used for recreation previously, especially Lake 3. These conditions explain the higher pH and Ca concentrations and maybe the higher P and chlorophyll concentrations and lower concentrations of Fe and Al in Lake 4.

The sediment data are presented in Fig. 108 and the parameter values and variations show a rough likeness to those of Lake 3. However, some differences seem obvious. In Lake 4 the pH has the same value throughout the sediment core, Ca, Fe and Al show generally somewhat higher concentrations and IL increases from 4 cm depth and up to the top sediment layer (the reverse of the case in Lake 3). One problem with this comparison is the different thickness of the subsamples (1 cm in Lake 3 and 3 cm in Lake 4) from the lake sediments. Increased thickness will probably conceal the parameter variations. Regarding the difference in the Ca, Fe and Al concentrations, the situation is somewhat obscure. The Ca concentration in the water is higher in Lake 4 (due to the liming) and consequently a higher concentration in the sediment seems reasonable. However, the water concentrations of Fe and Al are lower, but the sediment concentrations higher, and this phenomenon may be due to quite different deposition conditions. In the case of Ca, the deposition may be primarily determined by the Ca supply to the lake water, while the deposition of Fe and Al may be primarily regulated by the precipitation/sedimentation conditions. These conditions may have been favoured by e.g. higher pH in Lake 4. Some differences in the quantity and quality of the supply of inorganic seston may possibly also play a role in the interpretation of the results. However, some analyses have shown small quantities of inorganic seston supply to the lakes in Finnemarca.

#### L a k e 5.

The results are shown in Fig. 109. The variations of many parameter values follow the same pattern as the lakes discussed above. This applies to pH, Ca, Fe, Mn, Al, Si and P. Some variations of the other parameters are insignificant and others quite different. E.g. the N/S ratio (and  $E_h$ ) shows a clear maximum at about 6 cm depth, and the IL/N ratio a maximum at 8-11 cm with a decrease towards the sediment surface.

Some parameter values are generally both higher and lower in this lake than in Lakes 1, 3 and 4. This applies to Fe, Al, IL/N (higher values), Si and N/S (lower values).

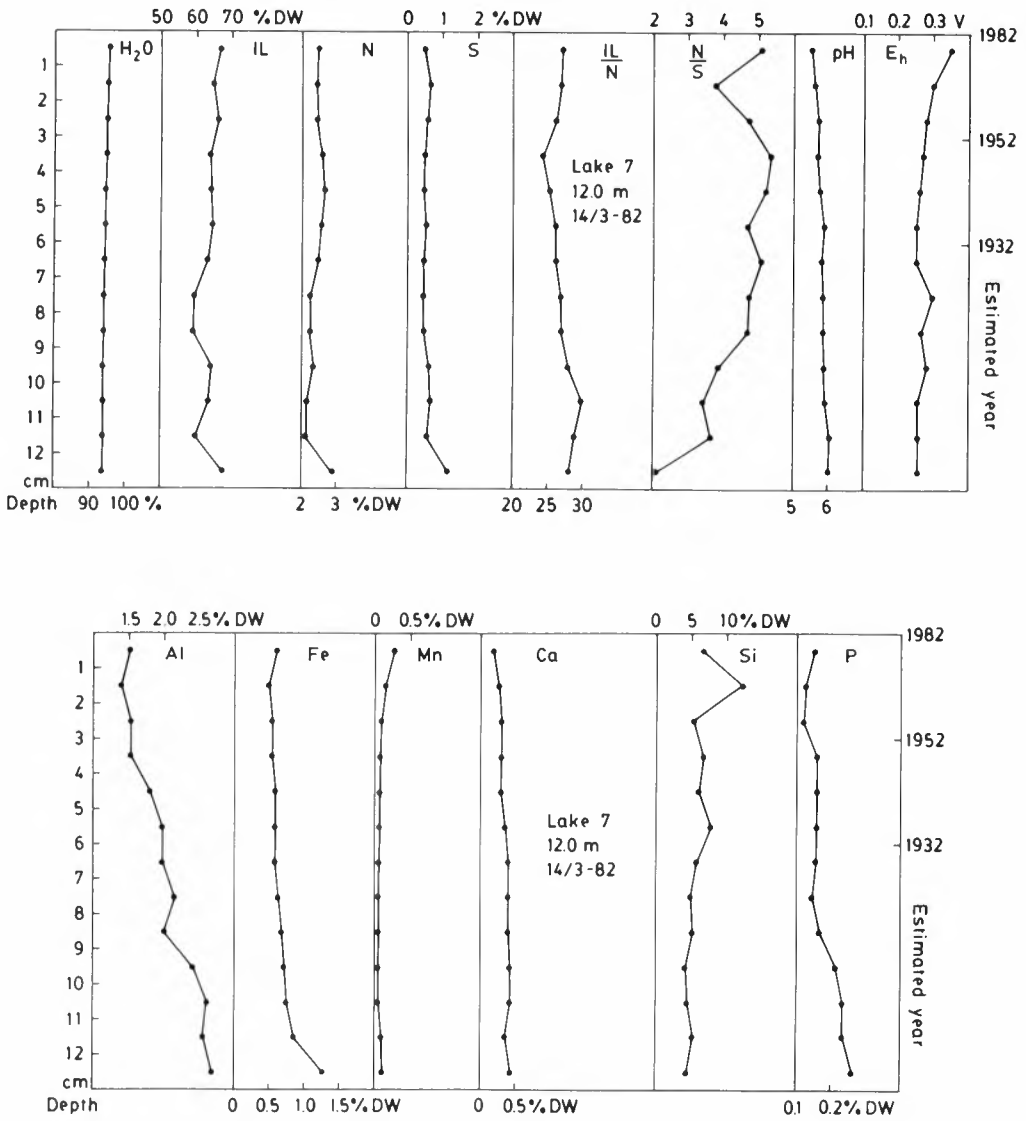

Fig. 111. Sediment analyses from Lake 7.

Lake 6.

This lake is supposed to have been acid for a relatively long time according to elderly local people, based on the lack of fish. In spite of this the lake seems to have established a somewhat lower pH (0.2 units) during the research period.

The sediment data are presented in Fig. 110. The most striking feature is the decrease in  $E_h$  and N/S and increase in Al with increasing sediment depth. IL and Mn seem to increase and decrease respectively downwards, as has been the case for most of the other lakes described above. The other parameters show a very small increase (pH, Fe, Ca, S and Si) or no significant changes at all (P, N, IL/N and  $H_2O$ ).

#### L a k e 7.

When discussing this lake, it is important to keep in mind the special location of the outlet in relation to the southern part of the terrestrial catchment, i.e. a significant part of the drainage water passes into the outlet as a shortcut flow without a normal mixing with the lake water, especially in the flood periods (see Fig. 9).

The parameter values are of the same order of magnitude as in the other lakes. This is shown in Fig. 111. Al, Mn, P and N/S show the most pronounced variations with sediment depth. Al and P increase and Mn decreases downwards. N/S also seems to decrease with exception of a maximum at 4 cm depth. The other parameters seem to change moderately.

#### L a k e 8.

The data are presented in Fig. 112 and show roughly the same values as in the other lakes. An exception is the N/S values, which are higher. The most conspicuous feature is the maxima at about 3 cm sediment depth in Al, Fe and N/S. Si and P also show relatively high values at this depth, which may be connected to the two first-mentioned components.

Some parameters seem roughly to decrease downwards, e.g. Mn, IL, N, N/S and  $E_h$ , while some others increase, e.g. Al, Ca and pH. The remaining parameters give a somewhat unclear picture or do not seem to change at all. The N/S ratio is somewhat higher than in the other lakes. This indicates a lower deposition of inorganic sulphur (Ødelien et al. 1973, 1975, Selmer-Olsen 1981), which again may be due to a lower reduction rate of  $SO_4$ . It is also worth mentioning that the N/S ratio decreases roughly parallel to  $E_h$ .

#### L a k e 10.

This lake is very deep and should consequently provide a relatively stable environment for sediment and deposition. This seems to be reflected in some parameter values, e.g. Mn (top layers), P and S, which are higher, and N/S, which is lower than in the other acid lakes (Fig. 113). The sediment data also show a general resemblance to those in Lake 5, and this seems likely because of their vicinity (neighbouring lakes) and relative similarity in morphometry.

With respect to parameter changes with depth, there seem to be an increase in Al, Ca, Si and P, a decrease in Mn, and a steady state or somewhat unclear situation for the other parameters. The low N/S ratio indicates a high rate of inorganic sulphur deposition and consequently a high rate of  $SO_4$  reduction.

#### L a k e 12.

The data are shown in Fig. 114. This lake seems to have a sediment chemistry, broadly speaking, like that of the other acid lakes. Al, Fe and IL show irregular variations, but roughly considered they seem to follow the same pattern. This may indicate a connection between these components in the precipitation, sedimentation and

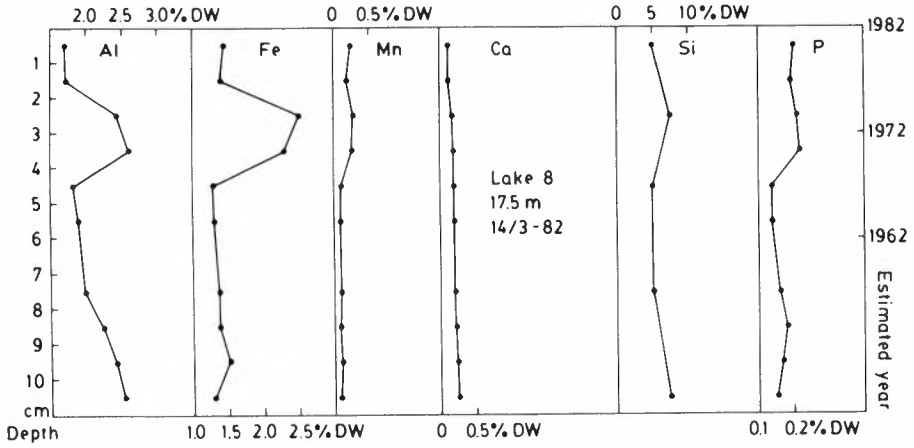
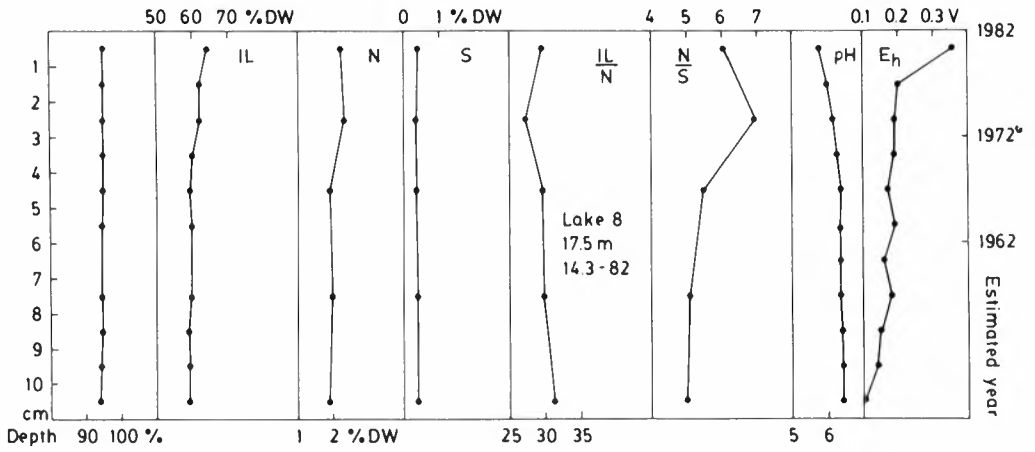

Fig. 112. Sediment analyses from Lake 8.

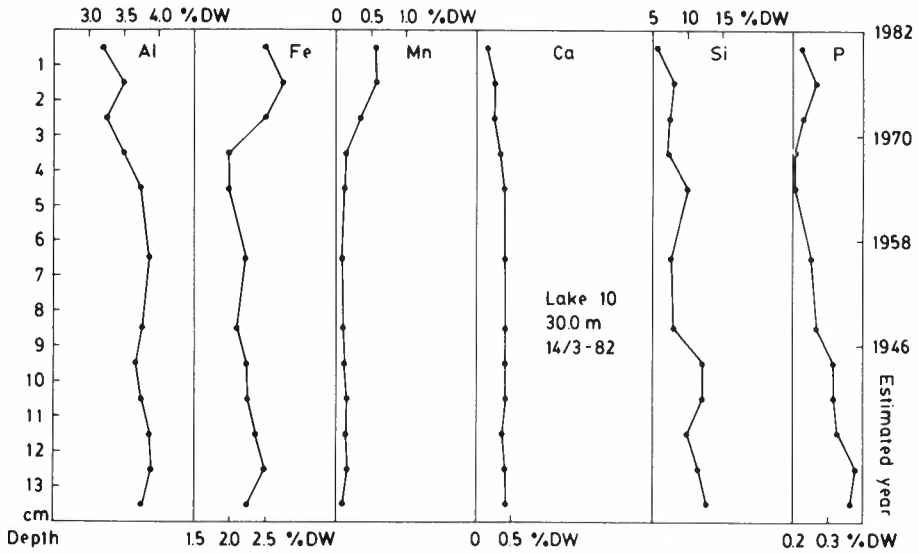
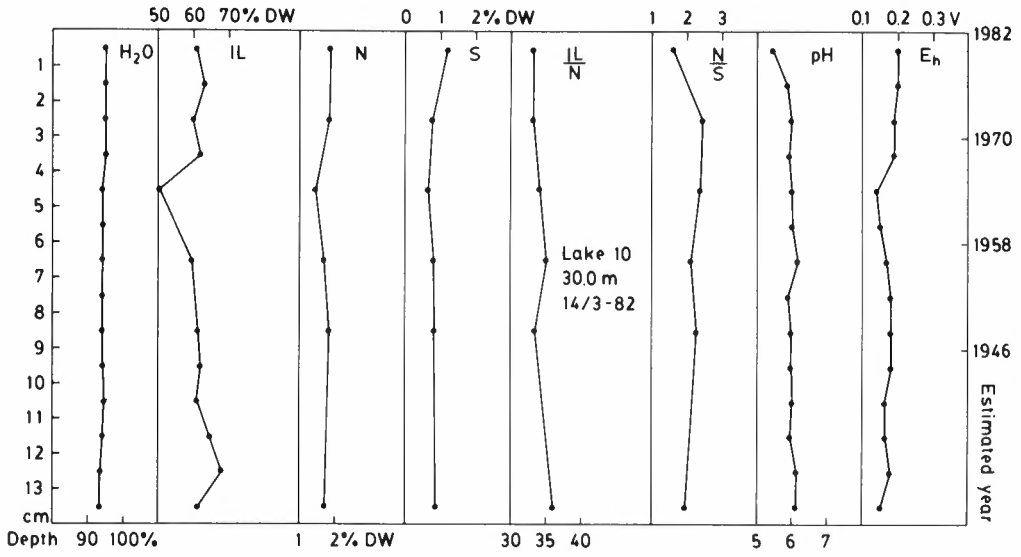

Fig. 113. Sediment analyses from Lake 10.

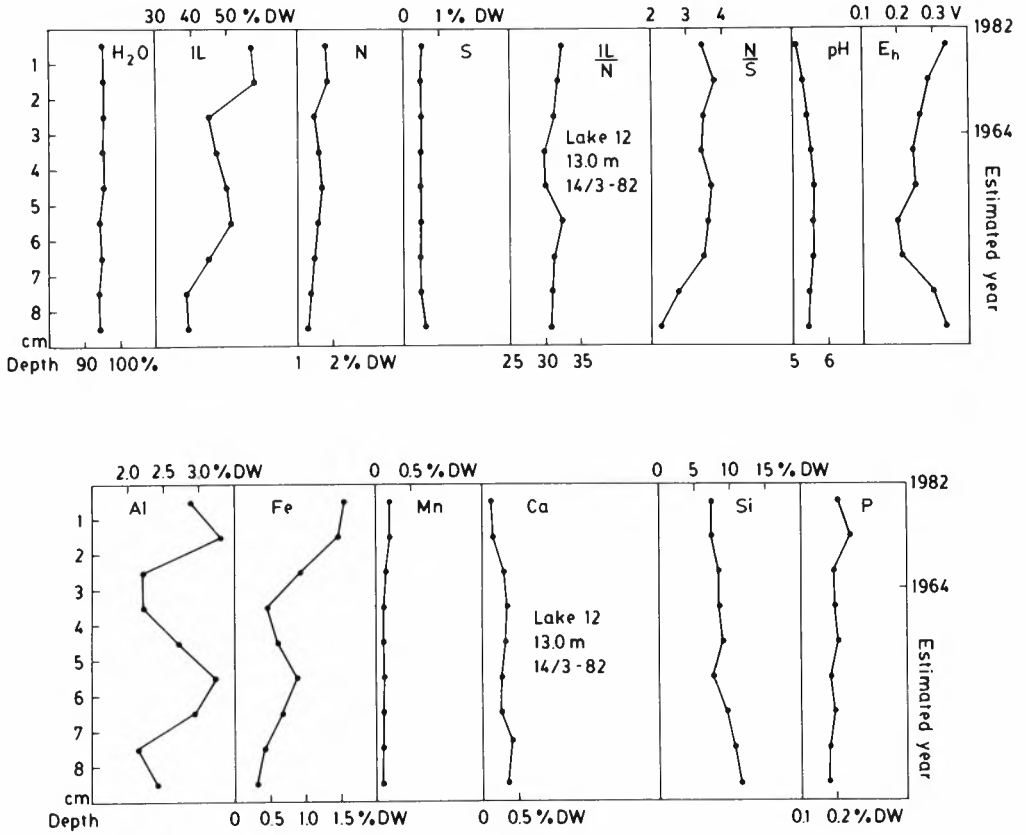

Fig. 114. Sediment analyses from Lake 12.

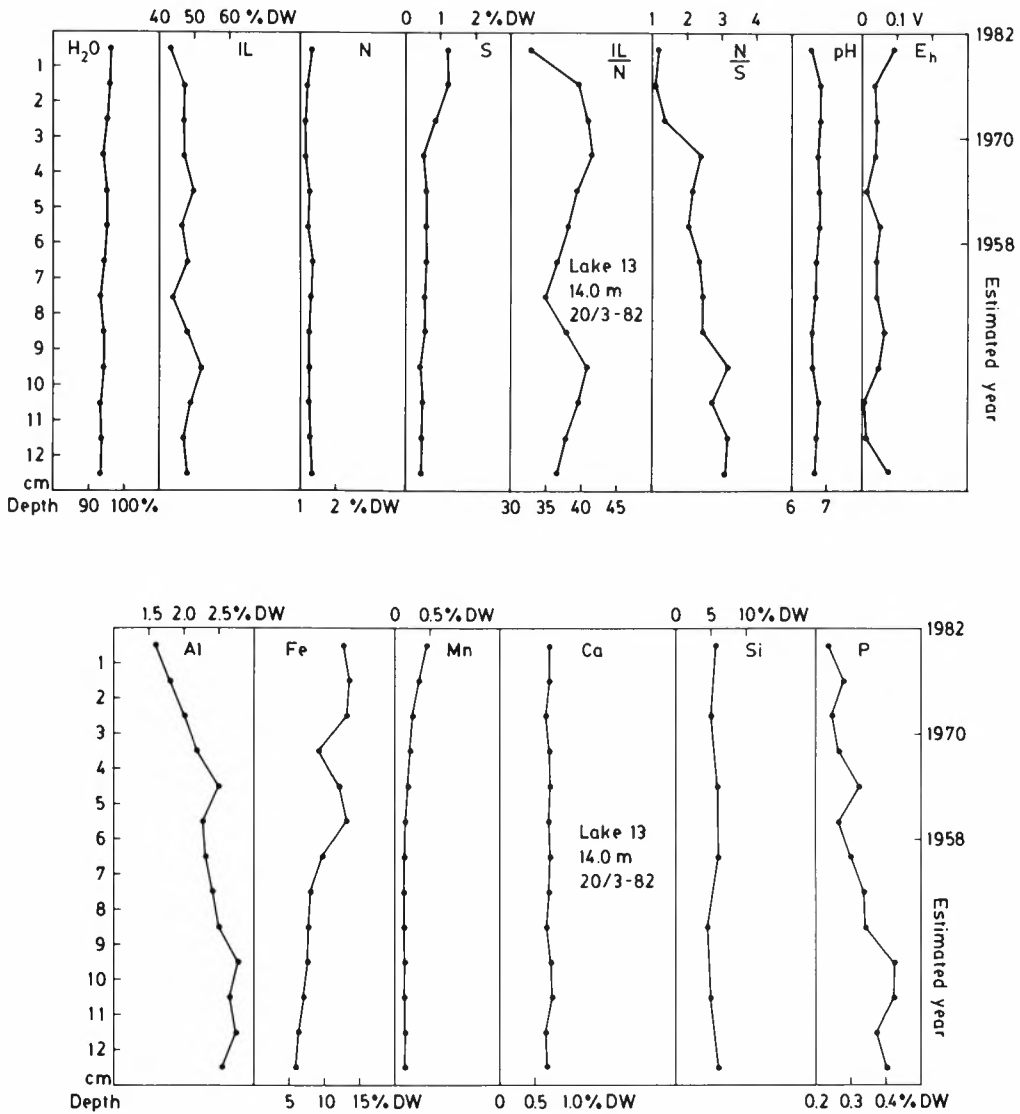

Fig. 115. Sediment analyses from Lake 13.

deposition processes. Fe, Mn, P, N, N/S and IL also seem to decrease with sediment depth. On the other hand, Ca, Si and pH show an increase downwards. The other parameters seem to be unchanged or irregular. The N/S ratio bears witness to a decrease in the inorganic sulphur deposited during recent years.

#### Lake 13.

This lake deviated from the others by not being acid. However, a significant part of the terrestrial catchment (the eastern part) is geologically like the acid lakes' catchments and consequently has acid runoff.

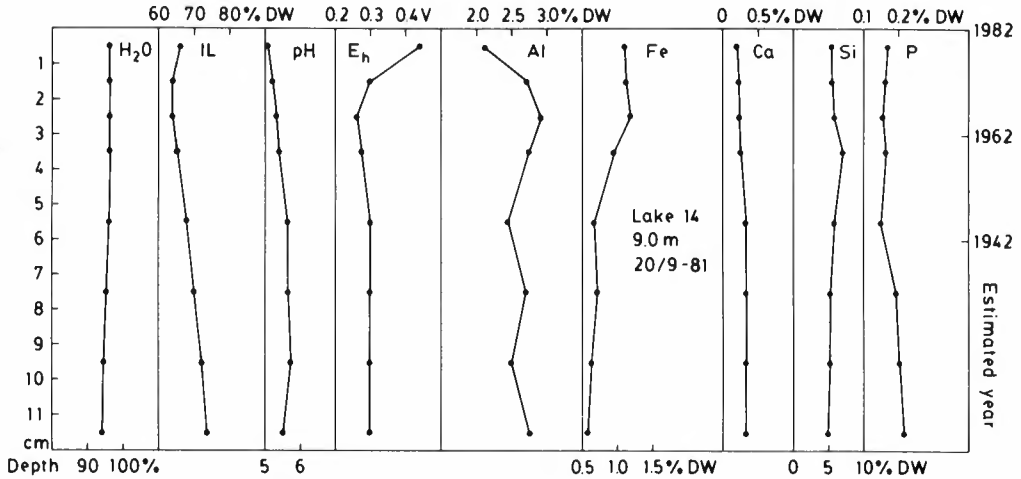

Fig. 116. Sediment analyses from Lake 14.

The sediment chemistry, which is presented in Fig. 115, also seems to reflect the lake's character. This applies to Fe, Ca, pH and  $E_h$  and partly to P, IL, N, S, IL/N and N/S. The first four parameters show higher (Fe, Ca and pH) and lower ( $E_h$ ) values than in the acid lakes. The other parameters mentioned show higher (P, S and IL/N) and lower (IL, N and N/S) values than in the acid lakes with some exceptions (e.g. Lake 5 shows about the same value for IL/N and Lake 10 about the same value for N/S). It is also worth mentioning that the IL values are influenced by the relatively high content of Fe connected to crystal water (Rannem & Hongve 1980).

The most striking feature of the chemical sediment stratification is the increase of Al, P and N/S and the decrease of Fe, Mn and S with the depth. The values of Fe, P and S in the uppermost layers may be considered together. Parts of the deposited Fe have probably been precipitated as FeS and this process may have prevented some P from being precipitated and subsequently deposited (Ohle 1953, 1954, 1955). The increase of S in the sediment top layers is supposed to be due to an increased  $SO_4$  supply to the lake in recent time. This presupposes steady redox conditions. The recorded redox potentials in the different sediment strata show roughly the same values, but it is doubtful whether these potentials are representative of the situation in the sediments at the time of precipitation and deposition. Kelly et al. (1982) mention that with an increased  $SO_4$  supply to lakes the reduction to sulphide may increase at the expense of  $CH_4$  production.

#### Lake 14.

Fewer parameters have been analysed on this lake's sediments. The results are presented in Fig. 116. IL, pH, Ca and P show a small increase and Fe a decrease with increasing depth. Al has a relatively low value in the top layer.

#### b) The reference lakes.

These lakes, located in Holleia, do not seem to have been acidified so far. They are shallow with a relatively short hydraulic retention time. The question is whether their non-acidified character will be reflected in the sediment chemistry.



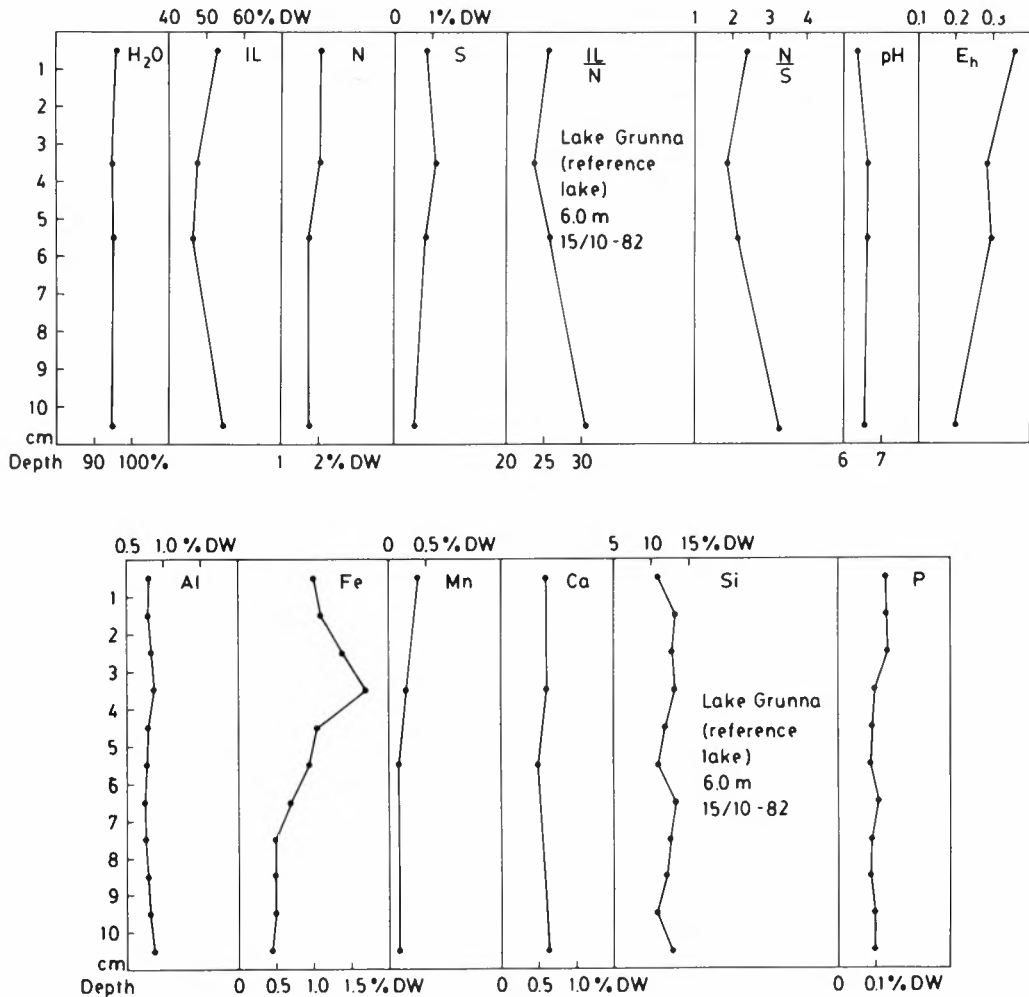

Fig. 117. Sediment analyses from Lake Grunna.

The same parameters as in many of the acid lakes have been analysed in the sediments of Lake Grunna and the data are shown in Fig. 117. The main impression is that these lake sediment values resemble those of Lake 13 (not acidified) with some exceptions, i.e. Al, Fe and P show lower and N, Si and E<sub>h</sub> higher values. In Figs. 118 and 119 the sediment data from Lakes Søriltjern, Haukevatnet and Øyvatnet are presented. These lakes show E<sub>h</sub> values more like Lake 13 than Lake Grunna. The Fe values and distribution in the sediments of the reference lakes are, roughly speaking, like the lakes investigated in Finnemarka (Lake Søriltjern deviated from the other reference lakes by showing a decrease of Fe in the uppermost sediment layers). The

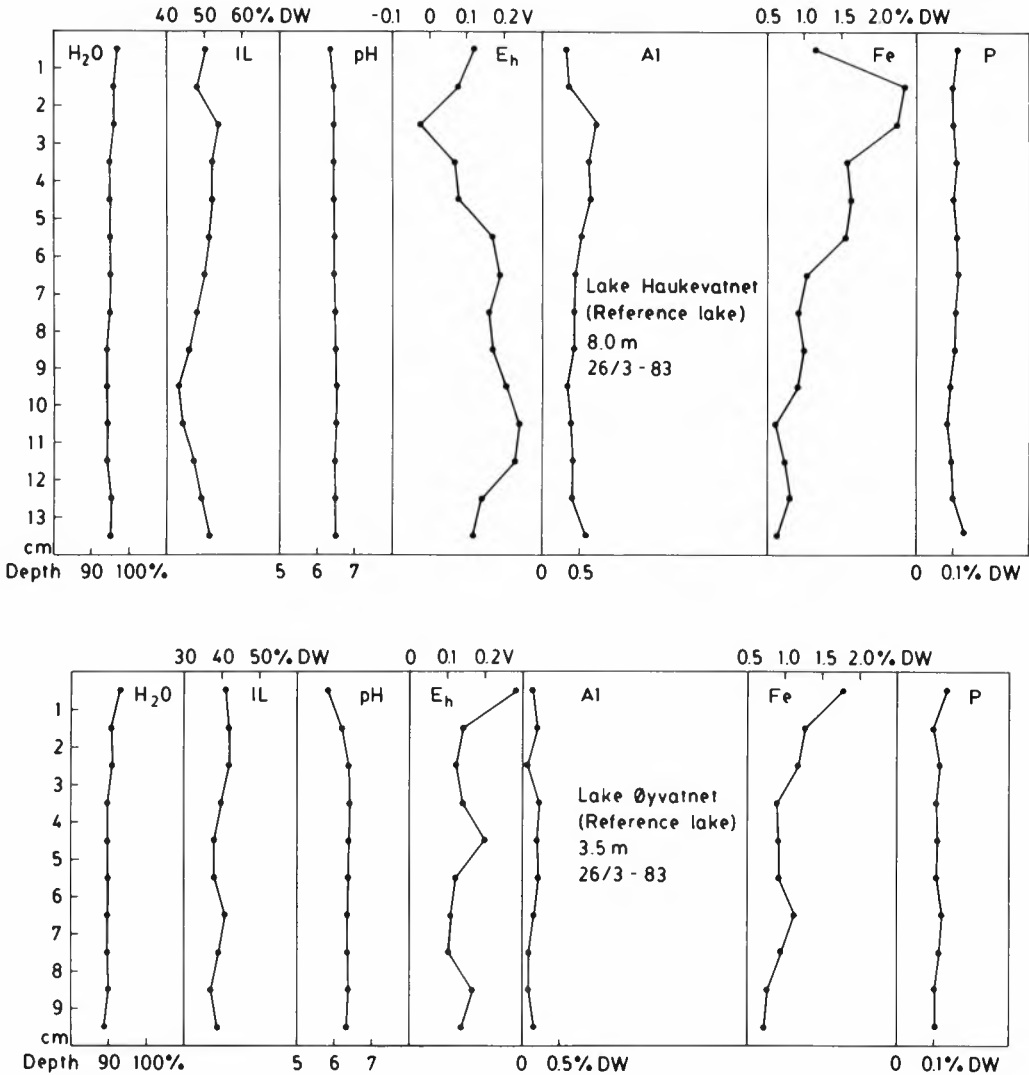

Fig. 118. Sediment analyses from Lakes Haukevatnet and Øyvatnet.

most striking feature of the reference lakes compared to the acid Finnemarka lakes seems to be the low values of Al, E<sub>h</sub> and N/S (analysed in Lake Grunna only), the somewhat lower values of IL, P and Fe, and the higher values of pH and Ca (analysed in Lake Grunna only) in the sediments.

*c) Lake comparisons.*

The question was whether the development (and the reasons for the development) of the character of the acid lakes could be seen by comparing the sediment chemistry of the acid lakes with the neutral lake in Finnemarka and the reference lakes in Holleia. The answer seems somewhat ambiguous and it is therefore only possible to make some indications in this regard.

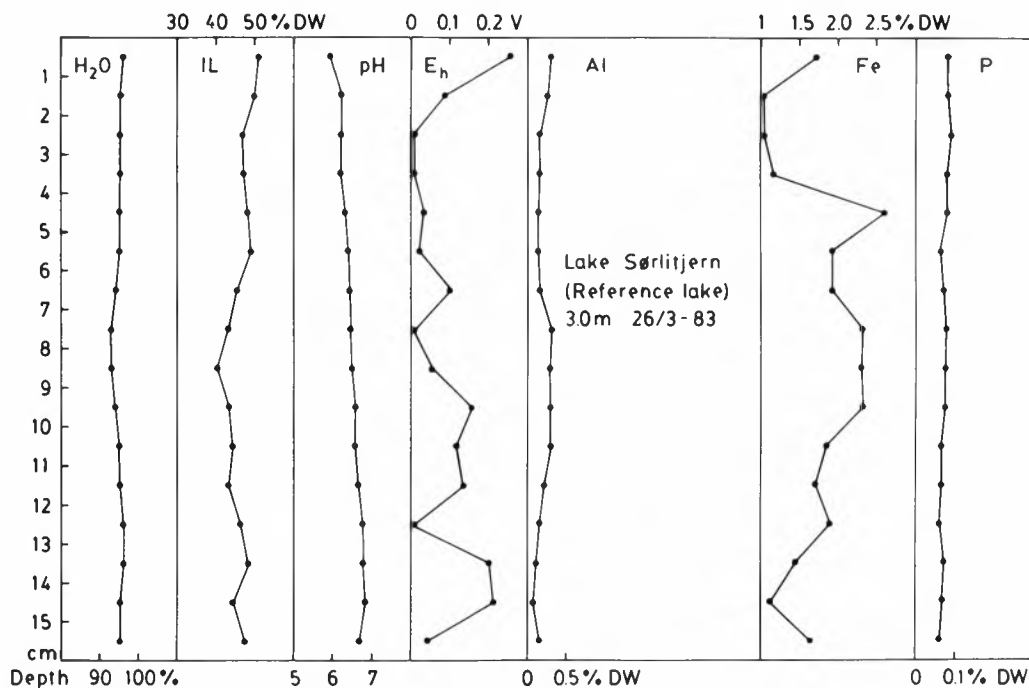

Fig. 119. Sediment analyses from Lake Sørilitjern.

The IL seems to have the highest values in the acid lakes, possibly due to reduced bacterial decomposition (Hendrey et al. 1976, Almer et al. 1978, Overrein et al. 1980). The «humic retention» (see Figs. 53-57) in Lake 13 seems to be at least on the same level as in the more acid lakes, and this may support a higher rate of decomposition, as the organic content in the sediments seems lower than in the acid lakes. Lake 13 is also assumed to have a relatively high production of autochthonous matter (see Fig. 123). This phenomenon may indicate an increase of IL along with acidification of the lakes. However, the autochthonous matter and other parameters may change simultaneously during an acidification process and disturb this possible relationship. The picture is also somewhat obscure regarding the IL data of the acid lakes. Some lakes show an increase and others a decrease towards the sediment surfaces. In addition, some research works have shown no decreased microbial activity in acidified freshwater sediment (Gahnstrøm & Fleischer 1985) and almost the same sediment oxygen uptake in acidified as in non-acidified lakes (Gahnstrøm 1985).

The amount of N in these sediments does not seem to distinguish significantly the lakes' character and development. The S values, on the other hand may possibly indicate an increased supply of SO<sub>4</sub> and/or an increased reduction of the SO<sub>4</sub> in the sediments (bottom water). Other studies (e.g. Mitchell et al. 1985) have attempted to relate the distribution of S in the sediments to atmospheric deposition of SO<sub>4</sub>, without clear findings. This may be because the atmosphere is not the only source supplying SO<sub>4</sub> to lakes; the terrestrial catchments may also be an important contributor (Ødelien et al. 1975, 1976). S may be released as H<sub>2</sub>S to the atmosphere and deposited in the sediments through a variety of pathways as mentioned below (see also Fig. 2): 1.

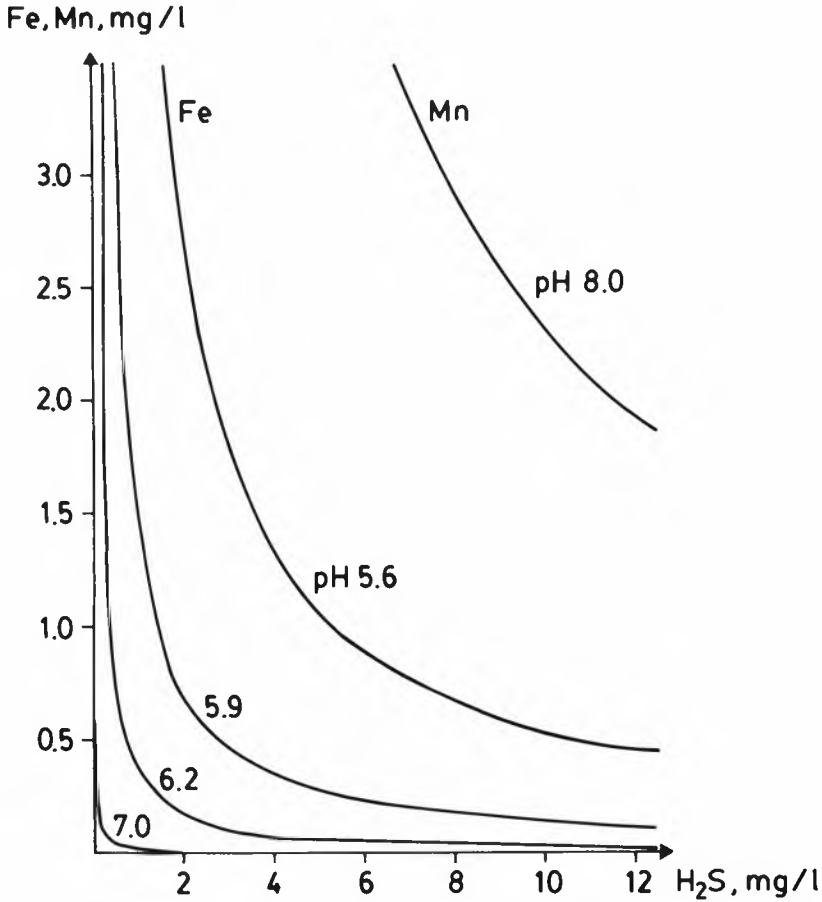

Fig. 120. Solubility curves of FeS calculated for different values. Modified after Hutchinson (1957).

Sedimentation of allochthonous and autochthonous organic matter. 2. Adsorption of sulphate on sedimenting detritus (see Sugawara 1951, Singh 1984). 3. SO<sub>4</sub> reduction with precipitation and sedimentation of sulphides from the bottom water (Schindler et al. 1980, Mayer et al. 1982, see also Davidson & Finlay 1986). 4. SO<sub>4</sub> reduction in the sediments (Hongve 1978, Grøterud & Hongve 1980) and precipitation of sulphides in the depths of the sediments (Norton et al. 1978, Carignan & Tessier 1985). Sulphides are also formed by anaerobic decomposition of organic matter, and redox reactions may produce other inorganic non-SO<sub>4</sub> components (Ødelien et al. 1973, 1975, Selmer-Olsen 1981). Dunnington et al. (1985) have shown that the putrefactive hydrogen sulphide production is about one third of the sulphate reductive production in two eutrophic lakes. This could possibly serve as an indication on the order of magnitude in the lakes investigated although the conditions in acidified-oligotrophic and eutrophic lakes are not directly comparable. The long term end product of sulphate reduction and other forms of sulphide production could also be organic S (Rudd et al. 1986). Thus the S content of a given sediment depth does not bear a direct relationship

to the S supply, but may indirectly (combined with other data) give a rough glimpse into the development of the lakes.

The IL/N ratios in these sediments seem to vary more or less arbitrarily and are consequently difficult to apply in a further discussion of the lakes' development. Worth mentioning is the fact that the ratios in question are highest in the lakes with the greatest depths (mean/maks.), e.g. Lakes 5, 10 and 13. This may be possibly connected to an efficient decomposition of the organic matter in the great volume of water. As the N-rich matter is most easily decomposed (Ruttner 1963), the organic matter reaching the sediments will be relatively N-poor. Lake 13 has, as already mentioned, a relatively high production of autochthonous matter and the proposed explanation could also give the impression of being somewhat speculative.

The N/S ratios, on the other hand, seem better to reflect important properties and development of the lakes. This ratio expresses the varying amount of originally inorganic sulphur supply ( $\text{SO}_4$ ) to the sediments. N/S is therefore a more suitable parameter than S to indicate a development of  $\text{SO}_4$  supply and/or a change of the redox conditions in the lakes. The N/S ratio is mainly determined by the supply of  $\text{SO}_4$  and the reducing power (mainly going to  $\text{CH}_4$  production). The latter factor is determined by the amount of decomposable organic matter, which liberated the electrons by microbial oxidation. An increase in the productivity of the lakes probably increases the reducing power, especially in the sediments. Taking into consideration the increase in the  $\text{SO}_4$  supply to the lakes during recent years (both in the drainage and precipitation), the N/S ratios are expected to decrease towards the sediment surface, presupposing a constant reducing power and pH. Of the lakes analysed, only Lake 13 seem to have such ratios. This may indicate reduced availability of electrons, and perhaps decreased pH with reduced precipitation of FeS, in the other lakes (especially in the sediments) in recent time, owing presumably to decreased primary production.

The differences in N/S between the lakes' sediments are mainly due to: 1. The  $\text{SO}_4$  supply, which is determined by the  $A_d/A_0$  ratio. A higher ratio gives a greater supply, because the  $\text{SO}_4$  concentration in the drainage water is more than twice that of the precipitation. This latter statement applies especially to Lake 13 and the reference lakes. 2. The reducing power (especially in the sediments), which is mainly determined by the supply of organic matter (particularly the autochthonous matter) and the  $\text{O}_2$  supply. The latter is determined by the depth and circulation conditions in the lakes (see Jensen 1983). 3. The formation of FeS, which is favored by high pH values, as shown in Fig. 120 (Hutchinson 1957). This applies especially to Lake 13 and the reference lakes. 4. The transformation of  $\text{H}_2\text{S}$  to organic S which seems to be a long term process (Rudd et al. 1986).

Using these considerations on the lakes analysed gives a roughly intelligible picture. The lakes with the lowest N/S ratios (Lakes 5, 10, 13 and the reference lake Grunna) seem to have one or more of the factors favouring high  $\text{SO}_4$  supply and/or reducing power. Lakes 10 and 13 have also shown relatively high retention values of  $\text{SO}_4$  (see Figs. 38-42). Lakes 6, 7, 8 and 12 show, broadly speaking, an increase in N/S towards the top sediment layers, indicating a decreased reducing power in the lakes. Lakes 3 and 4 are, however, obscure with respect to interpreting the water quality and ecology development by using the N/S ratios. Both lakes have low  $A_d/A_0$  ratios and are relatively shallow, with good circulation in the ice-free period. Lake 4 is also relatively

productive and both lakes are, as previously mentioned, supposed to have been more productive previously.

To evaluate the amounts of S in the sediments, a comparison with other known deposition measurements is important. Andersson (1985) found about the same S content in the sediments of the acidified Lake Gårdsjön as in this research. Ødelien et al. (1973) report in a literature review N/S values of 7-10 in mineral soils and somewhat over 4 in surface peat. From their own measurements, they reported N/S ratios of 2-2.5 from sediments of Lake Vannavatn, which they characterized as S-rich, largely composed of inorganic oxygen-free or oxygen-poor components. The author has calculated N/S on data from Brække (1981) and found values around 5 in surface peat. On this basis it could be concluded that N/S values of 7 or higher in the sediments may represent lakes with little inorganic or originally inorganic S and N/S values of 2 or lower lakes with great amounts of inorganic or originally inorganic S. The term originally is used because some reduced  $\text{SO}_4$  could be transformed to organic S in a long term process (Rudd et al. 1986).

Sediment pH has shown to be highest in the lakes with the highest pH, but for some the relationships are not quite clear. The humic rich acid Lake 8, for example, has about the same sediment pH as the reference lakes. The development of pH seems roughly to be reflected in the sediments, i.e. there is a weak decrease from the bottom of the cores and upwards in the acidified lakes in Finnemarka. A weak decrease has also been recorded in the reference lake Sørletjern and in the top layer in the reference lake Øyvatnet. Perhaps these two lakes have also been brought to incipient acidification.

$E_h$  has shown the lowest values in the reference lakes and Lake 13, which have not been acidified so far. This may indicate a greater reducing power in neutral than in acid lakes, and as a consequence the sediments should reflect an increased acidity development in the lakes. However, the  $E_h$  values are pH-dependent (low pH gives high  $E_h$ ) and the conditions are more complicated due to all the other factors determining the reducing power. Therefore only a very rough relationship seems to exist between  $E_h$  and pH (and  $E_h$  and N/S).

The Al content is significantly lower in the sediments of the reference lakes than of the Finnemarka lakes. The surprisingly high content in Lake 13 is connected to the acid drainage from the eastern part of the catchment. However, the composition and amount of seston supply to this lake, the reference lakes and the acid Finnemarka lakes may possibly be different due to differences in the geology of their catchments. This may complicate the interpretation of the results. There were small variations in the sediment cores from the reference lakes, in contrast to lakes in Finnemarka, which seem to decrease upwards (except Lakes 8 and 12, which show an irregular distribution). This is not easy to explain, especially because this decrease also occurs in Lake 13. The latter will be discussed first. In the north-eastern part of the lake, near the outlet, a brook has previously supplied acid, humic and Al-rich water from another brook outside the catchment. This water supply has been a result of an artificial arrangement in connection with transfer of small fish (trout) to the lake to help the fish recruitment. 10-20 years ago (the date is not exactly known) this supply was stopped, because of increased acidity of the water and extinction of trout. Although this brook water seems to have had a short flow in the lake because of the vicinity to the outlet, there is reason to believe that parts of this water may have reached the

lake's maximum depth (where the sediment core was sampled). It is therefore difficult to deduce any trend in the sediment recordings of Al in Lake 13.

Regarding the Al values in the acid Finnemarka lakes, the decreasing trend towards the sediment surface may be explained by the following hypothesis. Increased acidity of the runoff has led to an increased leaching of Al from the terrestrial catchments. The solubility of Al in the lake water, however, may have increased more than the increased leaching in the catchments, also due to increased acidity of the lake water. Consequently, decreased sedimentation is the outcome. Data from Kahl & Norton (1983) are at variance with this hypothesis. They report a weak increase in Al towards the sediment surface. Also data from Lake Gårdsjön seem quite obscure in this regard (Andersson 1985). This supports the observation that the Al distribution in sediments in connection with acidification is a complicated question.

The distribution of Fe in the sediments is roughly the inverse of Al in the Finnemarka lakes. Generally, an increase towards the uppermost layer (with some exceptions) seems to occur. This is in accordance with data from Kahl & Norton (1983) and Andersson (1985). The solubility of Fe is mainly determined by pH and  $E_h$ . Changes in these parameters, both in the soils (rocks) and in the lake waters, may explain the trend pointed out. In contrast to the Al distribution, the increased leaching of Fe in the terrestrial catchment may have exceeded the increased solubility in the lakes. Finally, the high Fe content in the sediments of Lake 13, which seems to agree with the relatively high retention value (see Figs. 78-82), could be of interest.

Mn shows the most unambiguous distribution in the sediment, with an increase towards the sediment surface. The explanation for this trend may be the same as for Fe (the two components have roughly the same solubility). However, there may also be other explanations. Lynn & Bonatti (1965), e.g., reported relatively high concentrations of Mn in the top layers of many deep-sea sediment cores from the Pacific. They suggest that Mn dissolves when incorporated into reduced sediments, then migrates and accumulates in the oxidized top layers. Skogheim (1976) mentions that such a post-depositional migration might also be expected in freshwater. A simple laboratory storing experiment with undisturbed sediment cores has made it possible to study this phenomenon. During one year, a dark 1-2 cm layer developed on the top of the sediment cores. Chemical analyses showed that this was Mn, and it is supposed that the dark colour is due to  $MnO_2$ . Kahl & Norton (1983) and Andersson (1985), however, have found an inverse Mn distribution to that reported above, indicating that the phenomenon is not universal, and that the redox conditions in the sediment and the boundary water layer may govern the whole.

Ca shows no stratification in the sediments from Lake 13 and the reference lake Grunna. On the other hand, a trend of decreasing values upwards in the sediments of the acid lakes seems obvious. This is in accordance to data from Lake Gårdsjön (Andersson 1985) and is assumed to be an acidification response, i.e. the lake water's increased acidity has reduced the Ca retention in the sediments. Charles & Norton (1986) report experiments with sediment cores and Ca values in recently deposited sediments in acidified lakes (Kahl & Norton 1983) which seem to support this. The Ca values are significantly higher in the neutral lakes than in the acid ones. Hegna (1986) has investigated two pristine lakes, one acidified and one not, which show roughly the same Ca distribution and difference as mentioned above.

SO<sub>4</sub> retention  
mg S/m<sup>2</sup> · year

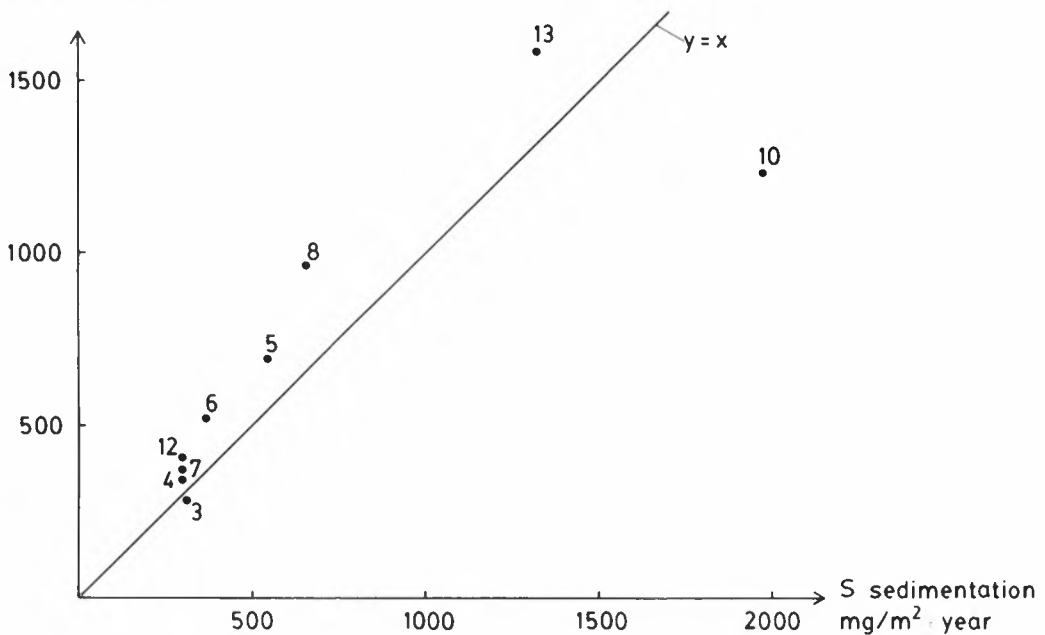

Fig. 121. Sulphate retention as mgS/m<sup>2</sup>·year in nine lakes in relation to the recent sulphur sedimentation as mg/m<sup>2</sup>·year (calculated on basis of sediment analyses and dating). The line describes equal proportions.

The Si values and distribution in the lake sediments give no clear picture of the situation. Regarding the values, there seems to be two groups of lakes, one with Si values of 10-15 % DW (Lakes 3 and 4 and the reference lake Grunna) and the other with values of 5-10 % DW (all the other lakes analysed). Some of the acid lakes show a weak increase in Si downwards in the sediment core. One could be tempted to explain this by the decreased concentration of diatoms, but owing to the special analytical methods used this explanation may be somewhat uncertain and speculative. The two acid lakes with the highest sediment Si values are shallow, clear water lakes, and the question is whether these lake types deposit higher concentrations in the sediments than deeper, more coloured lakes. These lakes also show higher retention values of Si (see Figs. 73-77).

Three groups of P values in the lake sediments seem obvious. Lakes 10 and 13 show values of 0.2-0.4 % DW, the other Finnemarka lakes 0.1-0.2 % DW and the reference lakes about 0.1 % DW. Lake Gårdsjön (Andersson 1985) shows sediment P values of the same order of magnitude as most of the Finnemarka lakes. Taking into consideration these data and some other research papers (e.g. Bøyum 1976, Skogheim 1976, Skogheim & Erlandsen 1984, Kjensmo 1978), it is difficult to see that the lake water quality and ecology are reflected in the P content in the lake sediments. According to Williams & Mayer (1972) it is doubtful that higher P values in the top of



sediment cores are connected to recent increased P loading of a lake, owing to diagenetic processes which may account for vertical variation of P in a sediment core. Skogheim (1976) mentions that the vertical distribution of P may be highly dependent on the distribution of Fe and Mn in the lake sediments and Andersson (1985) refers significant correlation between P, Fe and Al in the sediments of Lake Gårdsjön. This seems partly to be the case in the present investigation. E. g. there may be a connection between P and Al. In the reference lakes both the Al and P values are the lowest found in the sediments analysed. There is also a rough decrease in both P and Al from the bottom and upwards in the sediment cores of many of the acid lakes. Worth mentioning in this connection is that pH in these sediments is around 6, which is the optimal value for precipitating P with Al (Stumm & Morgan 1970). This indicates an increase in P in the lake waters in recent years. But although there is no analytical relationship between P and Fe in the sediments, the increased Fe upwards in the sediments may have brought about an increased P retention. In addition, there is reason to believe that the cessation of various activities (grazing and associated activities) has reduced the P supply to the lakes in recent time. Finally, Lakes 10 and 13, which show the highest P content in the sediments, also show high lake retention values (see Fig. 85).

### **5. Lake retention in relation to recent sedimentation**

By using the sediment analyses of the top layer and the calculated sedimentation rate, the annual amounts of various components per surface area in the sediments can be estimated. Due to several uncertainties (different analytical methods, difference in sediment quality between the sampling sites and other parts of the sediments, etc.), only sulphur has been given in a diagram together with the lake retention values. The diagram is shown in Fig. 121 and indicates that both the lake retention and recent sedimentation data are roughly reasonable. However, Lake 10 is the only lake which is satisfactorily placed in the diagram, i.e. below the equal line ( $y = x$ ). This reasoning is due to the fact that sulphur is also contributed from the allochthonous organic matter. Regarding the other plotted values in the diagram, the positions indicate losses of S, e.g. to the atmosphere as gaseous emissions (see Andersson - Calles & Eriksson 1979).

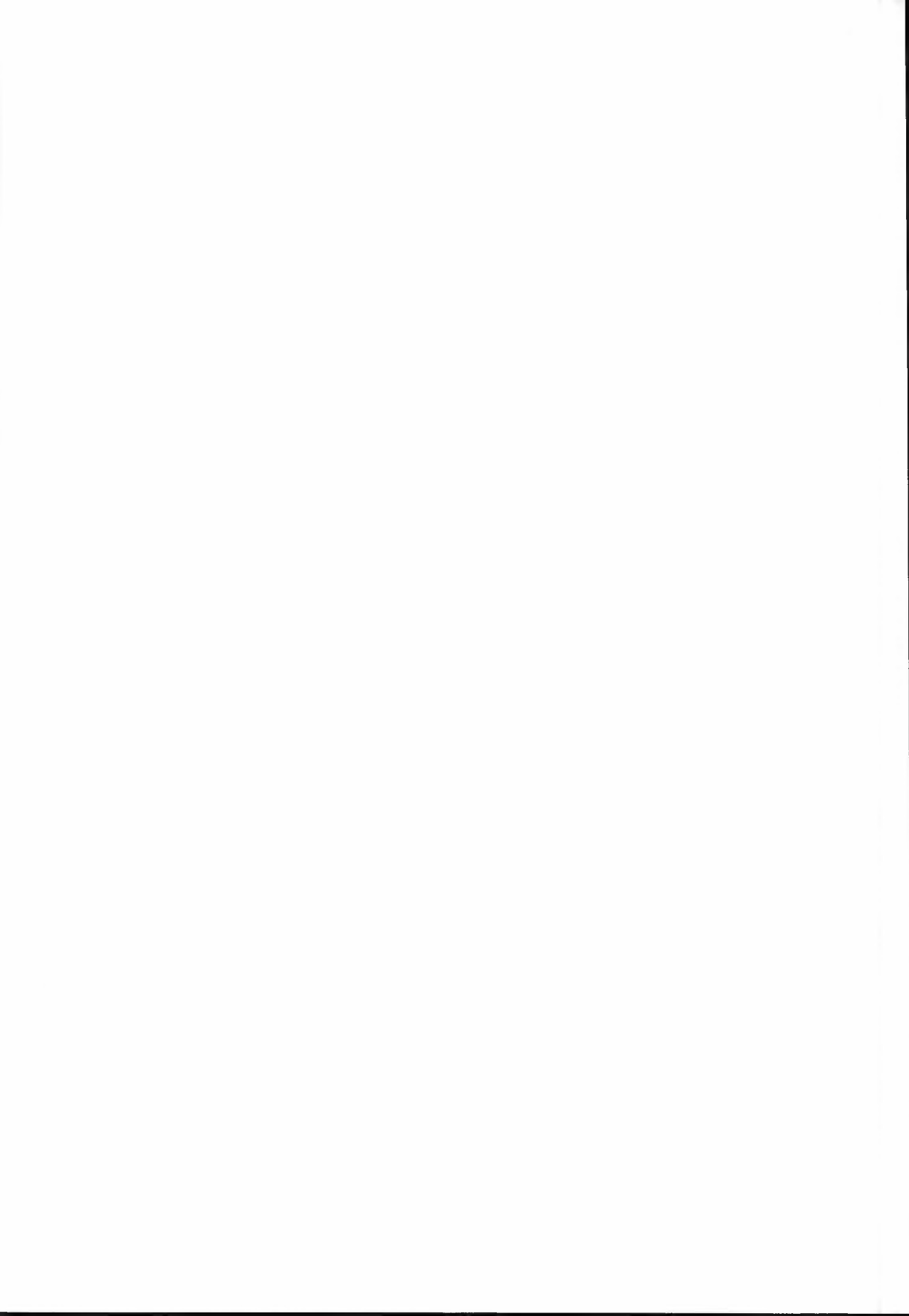

## IX. ALKALINITY BUDGETS CALCULATED ON THE BASIS OF MEASURED LAKE RETENTIONS FOR IMPORTANT IONS

Alkalinity production and consumption in lakes concerning S and N components have been discussed by Tirén (1981), and more generally by Kilham (1982), Kelly et al. (1982), Schnoor & Stumm (1985), Andersson & Olsson (1985), Cook et al. (1986), Schindler et al. (1986). Kilham (1982) refers to the first law of thermodynamics and the principle of electroneutrality to permit calculation of the acid-base budget from the input-output budget.

The budgets for the Finnemarka lakes are shown in Table 20. Only the most significant ions are taken into account. Although  $\text{HCO}_3$  in Lakes 4 and 13 and Al and Fe (Mn) ions in the other lakes could have been of interest, these have not been considered, due to capacity and methodical limitations. Some sporadic recordings of  $\text{HCO}_3$  in the inflow and outflow of Lake 13 indicate small differences. The  $\text{HCO}_3$  concentration in the outflow of Lake 4 is also assumed to be low from some measurements at pH higher than 5.

The most striking feature of the alkalinity budgets is the good balance between alkalinity production and consumption for Lakes 4 and 13 and the increasing excess of alkalinity consumption with increasing lake colour and  $Z/T_w$ . The negative values of some alkalinity consumptions are probably due to the liming of Lake 4 and partly Lake 10 and groundwater influx not analysed in Lakes 5 and 10. The difference between alkalinity consumption and production in Lake 4 would probably have been about the same as in Lake 3 if liming had not been performed.

The situation regarding the excess alkalinity consumption in the lakes is somewhat obscure. Some consumption may be due to uncertainties in the measurements and changes in storage of the components in the lakes (the measurements were taken in the outlets), but the main part may be connected to forms of alkalinity production not considered here. Since the excess is greatest in the lakes with the most colour and hydraulic loading, the unknown form of alkalinity production is supposed to have been caused by some kind of neutralization (decomposition) of humic acids.

When comparing the relative contributions to the alkalinity production from the  $\text{SO}_4$  and  $\text{NO}_3$  retentions, it seems obvious that the lakes with the highest  $Z/T_w$  may have a  $\text{SO}_4$  retention many times greater than the  $\text{NO}_3$  retention. For the lakes with  $Z/T_w$  less than 3 m/yr (No 3, 4, 5, 9 and 12), the ratio between the two retentions in question is around 1. An exception is Lake 7 ( $Z/T_w = 3.5$ ), which shows a ratio of 0.7, probably due to the previously mentioned short cut flow of some terrestrial water. This water has relatively low  $\text{NO}_3$  values.

Table 20. Alkalinity consumption and production calculated for the 15 investigated lakes on the basis of measured budgets for important ions during the period 1.oct. 1977 - 30.sept. 1980. The difference between alk. consumption and production should be due to uncertainties of the measurements, change in storage of the components in the lakes and other forms of alk. production not considered here

Lake No.	H <sup>+</sup> retention	Alkalinity consumption meq/m <sup>2</sup> . year		SO <sub>4</sub> <sup>2-</sup> , NO <sub>3</sub> <sup>-</sup> retention	Alkalinity production meq/m <sup>2</sup> . year		NH <sub>4</sub> <sup>+</sup> production	Alk. consump. - Alk. prod.	Unknown forms of alkalinity production and change in storage of the components involved, meq/m <sup>2</sup> . year
		Ca <sup>2+</sup> , Mg <sup>2+</sup> , Na <sup>+</sup> , K <sup>+</sup> retention	Alkalinity consumption meq/m <sup>2</sup> . year		Alkalinity production meq/m <sup>2</sup> . year	SO <sub>4</sub> <sup>2-</sup> , NO <sub>3</sub> <sup>-</sup> retention			
1	87		5 + 2 + 8 + 22 =	37	28 + 22 =	50	6	87 + 37 - (50 + 6) = 68	
2	211		15 + 8 + 24 + 60 =	107	72 + 9 =	81	5	211 + 107 - (81 + 5) = 232	
3	51		3 + 2 + 5 + 13 =	23	18 + 23 =	41	5	51 + 23 - (41 + 5) = 28	
4	67		-29 - 5 + 0 + 14 =	-20	21 + 25 =	46	6	67 - 20 - (46 + 6) = -5	
5	116		0 + 0 - 14 + 20 =	6	43 + 33 =	76	9	116 + 6 - (76 + 9) = 37	
6	120		6 + 3 + 11 + 16 =	36	33 + 19 =	52	5	120 + 36 - (52 + 5) = 99	
7	77		5 + 2 + 4 + 12 =	23	23 + 34 =	57	9	77 + 23 - (57 + 9) = 34	
8	192		17 + 8 + 20 + 82 =	127	61 + 12 =	73	11	192 + 127 - (73 + 11) = 235	
9	93		4 + 1 + 4 + 15 =	24	22 + 25 =	47	5	93 + 24 - (47 + 5) = 65	
10	196		-3 - 1 + 0 + 51 =	47	77 + 31 =	108	10	196 + 47 - (108 + 10) = 125	
11	159		3 + 2 + 6 + 14 =	25	60 + 25 =	85	9	159 + 25 - (85 + 9) = 90	
12	66		3 + 1 + 5 + 17 =	26	25 + 25 =	50	5	66 + 26 - (50 + 5) = 37	
13	37		27 + 8 + 16 + 50 =	101	99 + 39 =	138	0	37 + 101 - (138 + 0) = 0	
14	92		5 + 3 + 1 + 21 =	30	35 + 24 =	59	6	92 + 30 - (59 + 6) = 57	
15	108		4 + 2 + 6 + 21 =	33	41 + 29 =	70	9	108 + 33 - (70 + 9) = 62	

## X. A MODIFIED VOLLENWEIDER MODEL APPLIED TO THE LAKES

### 1. Phosphorus

Vollenweider (1976) developed his P loading model for large, deep lakes. Lande et al. (1980), Berge (1982) and Johannessen et al. (1984) have used a modification in minor lakes. However, the first modification was made by Rognerud et al. (1979) with data from some large, deep lakes in Norway.

Vollenweider (1976) defines the retention time of phosphorus ( $T_p$ ) by analogy with the retention time of water ( $T_w$ ) and establishes the following equation:

$$\frac{T_p}{T_w} = \frac{P_l}{P_i}$$

where  $P_l$  is the phosphorus concentration in the lake and  $P_i$  the same in the water supply to the lake. Then he plots  $T_p/T_w$  as a function of  $T_w$ . This function is not satisfactory for Norwegian lakes, according to Rognerud et al. (1979). Consequently, they modified the function, as previously mentioned, by plotting the data from the Norwegian lakes in a semilogarithmic diagram. A straight line has been adapted to the data and represents the modified function. The author has used the same reasoning and plotted the lakes from Finnemarka in the same type of diagram.  $T_w$  is calculated by means of the «standard run-off values» (see Chapter IV) and  $T_p$  by means of the mean recordings during 1977 - 80. This is a weakness in the data basis, even if the  $T_w$  would not have been much different using runoff data from 1977-80. The result is shown in Fig. 122. As apparent from the diagram, the lakes have been adjusted to two different straight lines. The two equations for these lines, converted to logarithms, are:

$$\log \frac{T_p}{T_w} = -0,197 T_w - 0,239$$

n = Lakes 3, 4, 5, 10, 12, 13, 14, r = - 0.986, p < 0.001

$$\log \frac{T_p}{T_w} = -0,178 T_w - 0,117$$

n = Lakes 1, 2, 6, 7, 8, 9, 11, 15, r = - 0.984, p < 0.001

Combining these two equations with the equation above gives:

$$\log \frac{P_l}{P_i} = -0,197 T_w - 0,239$$

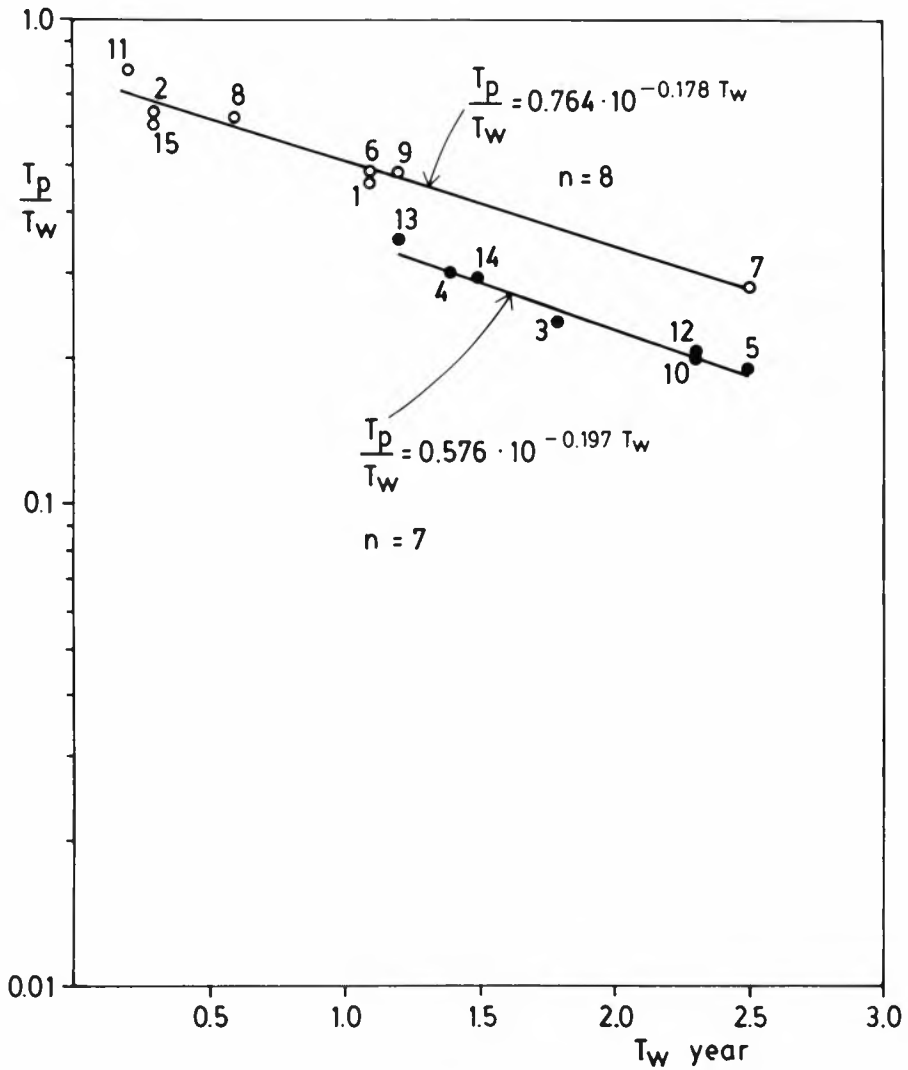

Fig. 122. The retention time of phosphorus - retention time of water ratio of the lakes in relation to the retention time of water. The line of the black points describes the regression for Lakes 3, 4, 5, 10, 12, 13 and 14, and the line of the white points the regression for Lakes 1, 2, 6, 7, 8, 9, 11 and 15.

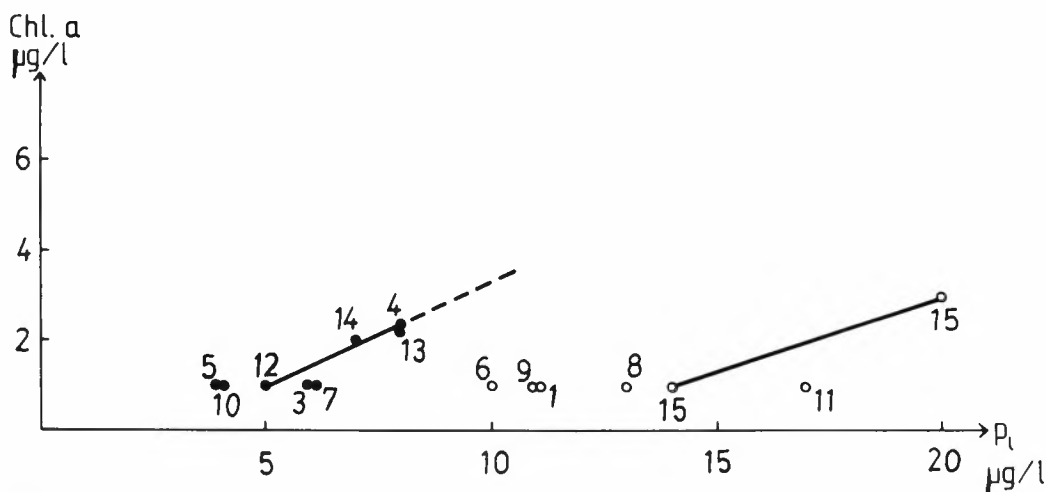

Fig. 123. Chlorophyll a values as  $\mu\text{g/l}$  in the lakes in relation to phosphorus as  $\mu\text{g/l}$ . The line of the black points describes the assumed relationship for the black point lakes in Fig. 122, and the line of the white points the assumed relationship for the white point lakes in the same figure.

$$\log \frac{P_1}{P_i} = -0,178 T_w - 0,117$$

Using these equations it may be possible to calculate the change in lake concentration with changed P loading or hydraulic retention time, change in the P loading with changed lake concentration or hydraulic retention time and change in hydraulic retention time with changed P loading or lake concentration.

The P supply to the lakes is mainly connected to humic substances from the terrestrial catchments and particulate matter from the atmosphere (precipitation). Both components are originally little available to algae. The lakes with the highest  $Z/T_w$  are dominated by humic P loading and those with the lowest  $Z/T_w$  by atmospheric P loading. There is reason to believe that the P loading to the lakes has changed during history. Two main sources of P are in focus in this regard. First, atmospheric pollution may have increased the P supply, but it is questionable whether this has also increased the algae-available P. Analyses have shown relatively small amounts of  $\text{PO}_4$  (7  $\mu\text{g/l}$ ) even when the total P concentration has been high (35  $\mu\text{g/l}$ ). Second, the cessation of grazing and associated activities in the area may have significantly reduced the P supply to the lakes in recent years. These P components are supposed to have been highly available to algae. The cessation of grazing has brought about invasion of heathers, mosses and trees at the expense of grasses in the catchments, which has probably increased the sorption of P in the soil and vegetation. In the spring and autumn the author has measured relatively high concentrations of  $\text{PO}_4$  in surface runoff from an old meadow at an abandoned mountain farm, which indicates a  $\text{PO}_4$  supply in previous time which today nearly has come to an end. The  $\text{PO}_4$  in question

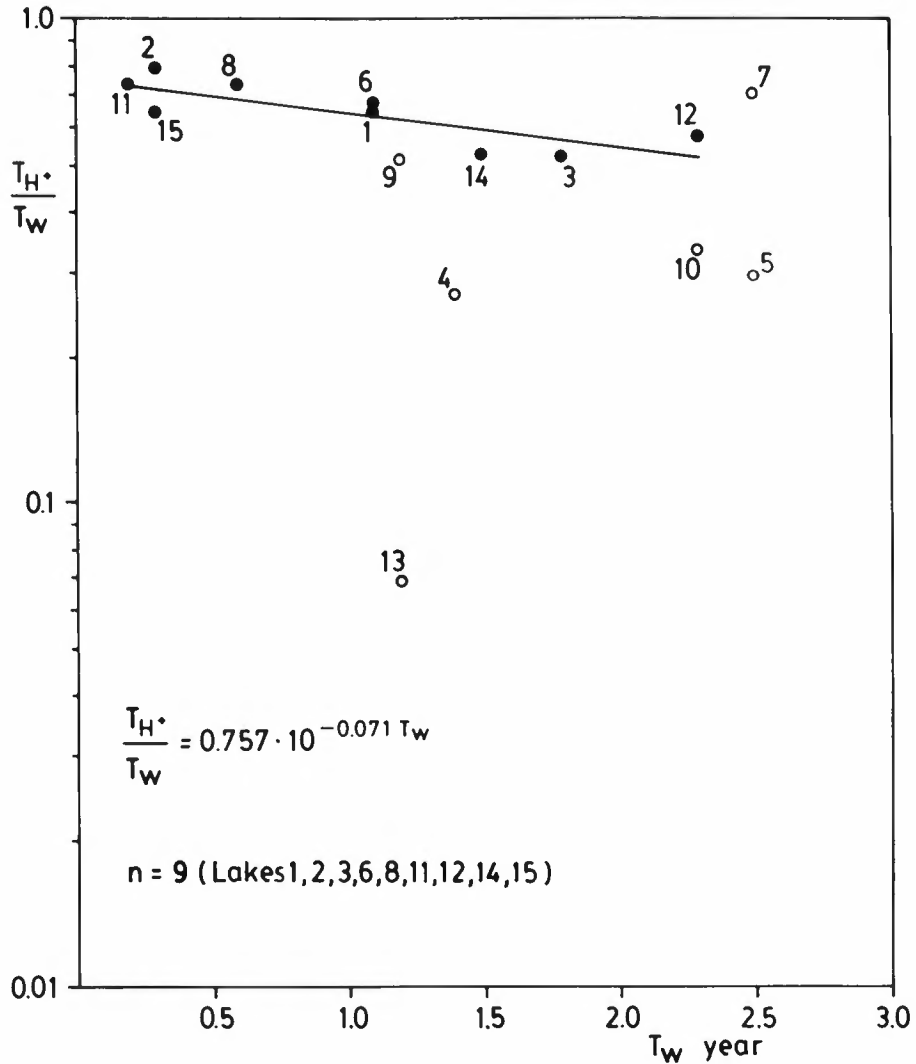

Fig. 124. As Fig. 122, but with respect to hydronium (instead of phosphorus) and with only one regression line, i.e. for Lakes 1, 2, 3, 6, 8, 11, 12, 14 and 15 (black points). The other lakes (white points) do not fit very well and have also shown «deviating characteristics».

probably comes from organic matter, primarily plant debris from grass species after freezing and thawing (Grøterud 1972a, Uhlen 1979, Bjerve 1981). Uhlen (1979) has also shown that plants more resistant to decomposition, e.g. heathers, release considerably less  $PO_4$  than grass species. It could also be mentioned that the investigation by Uhlen (1979) and that of the author in the runoff from the old meadow bear witness to a neutralization ability in the grass species after freezing and thawing. The heathers do not have this ability; to the contrary, they will acidify the water according to data from Uhlen (1979).



To illustrate the situation a rough calculation has been made to find out the necessary increase in P loading to increase the mean concentration in the lake with varying values. E.g. in Lake 3 it seems necessary to increase the P loading by 1-2 kg per year to obtain an increase from 6 to 8  $\mu\text{g/l}$  in the lake water. The next important question is what kind of response this increase will lead to. To elucidate this, knowledge of the relationship between P concentration and algae volume is desirable. Unfortunately, this has been only sparsely investigated in the Finnemarka lakes. However, the modest data existing have been presented in Fig. 123. This diagram must only be used as a rough guide with respect to the relationship between algae volume, expressed as chlorophyll a, and P. The two lines in the diagram have been drawn from a starting level which is somewhat obscure, due to the fact that many lakes with different P values have shown chlorophyll a values  $< 2 \mu\text{g/l}$  chlorophyll a and 5  $\mu\text{g/l}$  P have been chosen as the starting point for the lake group with P concentrations  $< 10$  (belonging to the lowest equation in Fig. 122). The argument for this is that 1 is considered as the average of 0 and 2  $\mu\text{g}$  chlorophyll a/l and 5  $\mu\text{g}$  P/l is the mean value for the five lakes involved. Regarding the other lake group (the uppermost equation in Fig. 122), Lake 15 has been both the starting point and the highest value of the line, due to the fertilizing experiment presented in this paper. All the other lakes of the group have shown varying P concentrations with all the chlorophyll a values less than 2  $\mu\text{g/l}$ . Regarding Lake 3, the P increase from 6 to 8  $\mu\text{g/l}$  may, according to Fig. 123, give an algae volume of about the same size as in Lakes 4 and 13. The values of P and chlorophyll a and the response to P fertilization in the Finnemarka lakes seem likely, compared with other lakes of similar type (see Lande et al. 1980, Johannessen et al. 1984).

## 2. Hydronium

The idea of attempting to use the model on hydronium emerged when studying the argumentation by Vollenweider (1976). However, the function between  $T_{H^+}/T_w$  and  $T_w$  is not as clear as has been shown for P. This is obvious from Fig. 124, and six lakes have also been cancelled owing to the great discrepancies in the diagram and special characters of the lakes. The lakes cancelled have been previously termed «deviation lakes» (see Chapter VII) and seem to confirm this name.

Converted to logarithms and combined with the equation

$$\frac{T_{H^+}}{T_w} = \frac{H_1^+}{H_i^+}$$

the equation becomes:

$$\log \frac{H_l^+}{H_i^+} = -0,071 T_w - 0,121$$

$$n = \text{Lakes } 1, 2, 3, 6, 8, 11, 12, 14, 15, r = -0.806, \\ p < 0.005$$

where  $H_1^+$  and  $H_i^+$  are the hydronium concentrations in the lake and the water supply respectively. This equation may be further changed by introducing pH:

$$\text{pH}_1 - \text{pH}_i = 0.071 T_w + 0.121$$

In a rough connection this equation may be used for calculating lake pH with changed hydronium loading or hydraulic retention time, change in the hydronium loading with changed lake pH or hydraulic retention time and change in hydraulic retention time with changed hydronium loading and lake pH.  $T_w$  can be estimated by means of the measured precipitation at the Fossum meteorological station (see Chapter IV).

If the lake behaves like a reactor, with no transformation of the supplied components, the differential equation of Rainey (1967) could be used to estimate the concentration change in the components with time in the lake as a result of change in the input rate. In an integrated form the equation is:

$$C_t = C_i + (C_o - C_i) e^{-\frac{t}{T_w}}$$

where  $C$  represents concentration,  $C_i$  in the input,  $C_o$  at the start and  $C_t$  after time  $t$ , and  $T_w$  is the hydraulic retention time. By comparing this type of calculation with that based on Vollenweider's model, the lakes' buffering properties (selfpurification) may be revealed (see Grøterud & Hongve 1980, Grøterud 1981). A mass balance model presented by Dillon et al. (1982) is also worth mentioning in this connection. This model was used in Lake Gårdsjön (Hultberg 1985).

In conclusion, it may be mentioned that the calculation discussed above could probably also have been made very roughly by means of the retention data (Chapter VII).

## XI. TENTATIVE CONCEPTUAL MODEL OF HUMIC MATTER TRANSFORMATION IN THE LAKES

Humic matter is commonly regarded as a slowly decomposable substance (e.g. Ryhänen 1968, Sederholm et al. 1973, Gjessing 1976). The decomposition in lakes is supposed to be mainly biogenic, although chemical processes may occur (Lønnerblad 1930, 1931, Strøm 1931, Åberg & Rodhe 1942, Granéli 1977, Gulbrandsen 1980).

In this chapter the author focuses mainly on the link between humic matter - fish - alkalinity production. Fish (together with other organisms) are able to produce alkalinity by decomposing the humic matter (humic acids) via zooplankton, bacteria and insect larva, water boatmen (see Chapter V) and water beetles. This is shown in Fig. 125. The model has been made simple in order not to lose the general view. From an ecological point of view it is assumed that, by removing the fish, the total decomposing process may be significantly changed with possibly reduced alkalinity. On this basis, the author puts forth the hypothesis that the disappearance of fish in acid-sensitive lakes may accelerate the acidifying process.

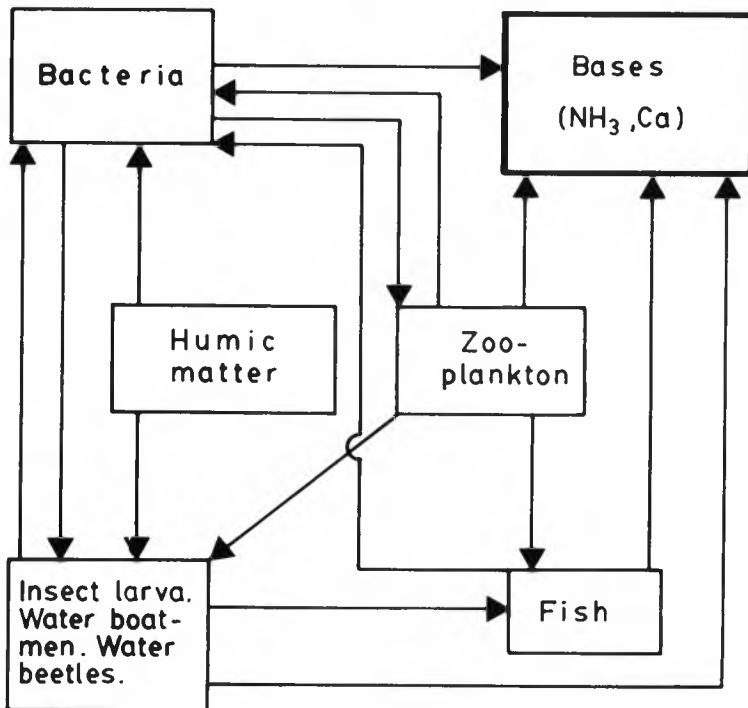
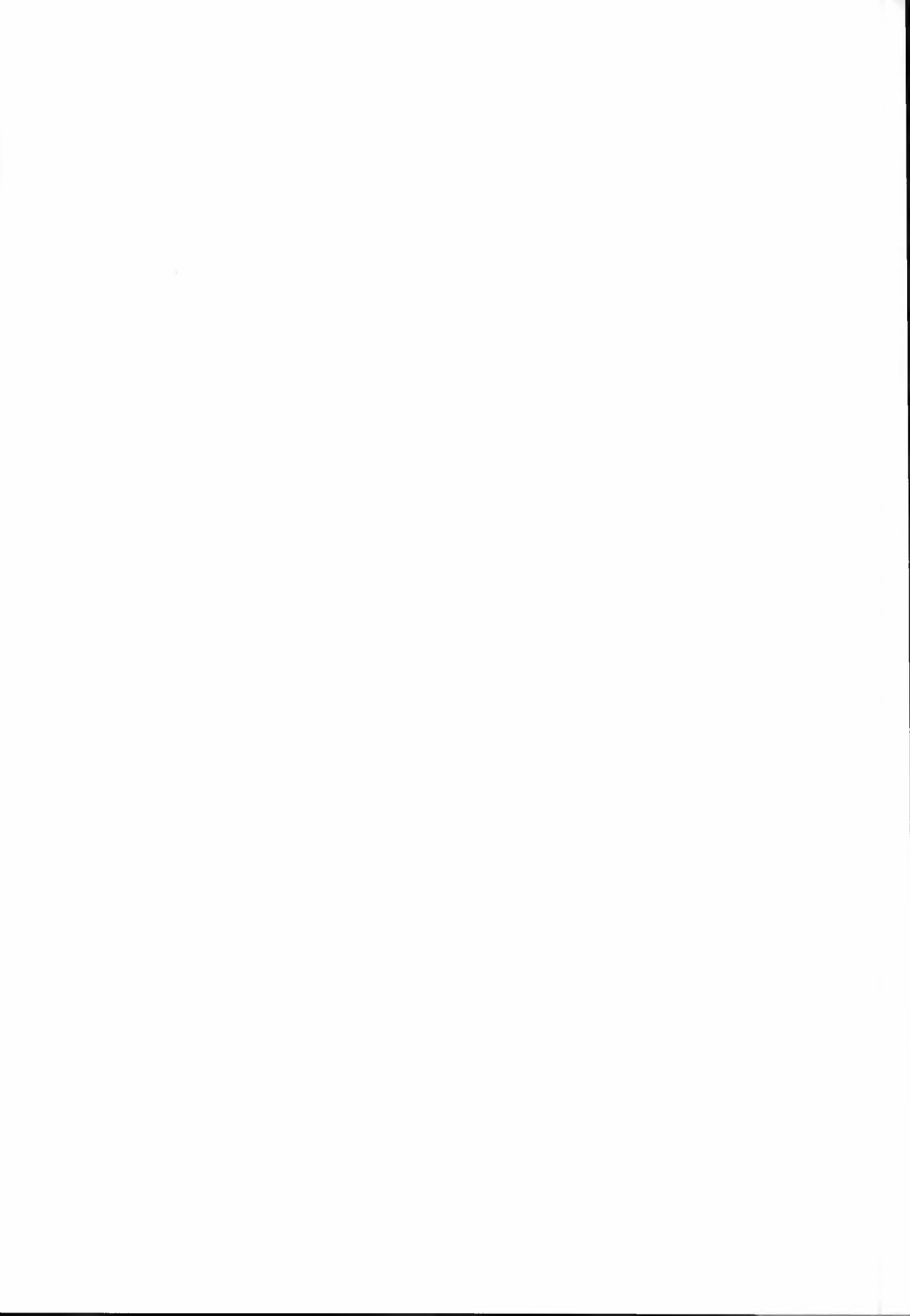

Fig. 125. Tentative conceptual model of humic matter transformation in the lakes.



## XII. THE DYNAMICS OF ACIDIFICATION INDICATED BY A CONCEPTUAL MODEL

This chapter is an attempt to approach the dynamics of acidification by synthesizing the knowledge from the previous chapters. In addition, this complex problem has demanded comparison of photos from earlier and recent times, interviews and observations not recorded here. The author has used the research area for recreation since childhood and is therefore quite familiar with the locality.

The model is presented in Fig. 126, and is a modification of a previously published model (Grøterud 1984a). The boxes depict changes in the ecosystems and the arrows the effects these changes can make. The central box with the increased acidity of the lake water (the final result) is drawn with a heavy line. The heavy arrows indicate processes of much greater effect than the thin arrows, i.e. the terrestrial and atmospheric contribution to the acidification. The limnic acidification, on the other hand, consists of many effects which are weak when considered separately, but not necessarily when combined. Broken arrows denote great uncertainty in evaluation of the effect.

Such a model does not need circumstantial comments, but some will all the same be given. It seems most correct and practical to start with the acidified lake water (the central box). This is relatively strongly affected by increased acidity of the runoff, which is an integration of increased acidity of the soil and the precipitation, including dry deposition. The change in soil acidity is coupled to change in the vegetation, which again is determined by the cessation of grazing and associated activities (e.g. Rosenqvist 1977, Rosenqvist et al. 1980). The climate may possibly also be of importance in this regard. The yearly mean air temperature seems to have decreased somewhat during the period 1940-1970 (see Pleyrn 1978). Important to note is that the increased acidity of the precipitation does not only include strong acids, but also salts of these acids. By contact with the humic matter in the catchments, these salts may produce strong acids by cation exchange with the hydronium ions from the humic acids.

The central box also receives one thin arrow from the precipitation box which describes the direct acid deposition on the lake surface. In addition, six thin arrows (two broken) lead into the box constituting the limnic contribution to the acidification dynamics. Five arrows also point out of the same box, indicating feedback mechanisms. One key mechanism in the limnic acidification is the decreased availability of P in the limnic ecosystem. This may lead to an oligotrophication of the lakes, which may subsequently result in a decreased lake metabolism rate (see e.g. Grahn et al. 1974, Anderson et al. 1978) with an increased redox potential, especially in the sediments. The reduced availability of P is related to decreased supply from the catchment through the cessation of waste products from cattle grazing, the human activities connected to grazing and an increased sorption of P by the changed vegetation (which decomposes more slowly). P is possibly also indirectly determined by the assumed increased leaching of iron from the catchment in response to increased acidity of the runoff. This iron may be precipitated with P in the lake. Further, P may be regulated by an interaction between increased acidity and decreased metabolism rate in the lake through an increased sedimentation of humic matter, or possibly by a feedback mechanism acting through an increased re-oxidation of iron during lake turnover. This effect is denoted with great uncertainty because the oxidation

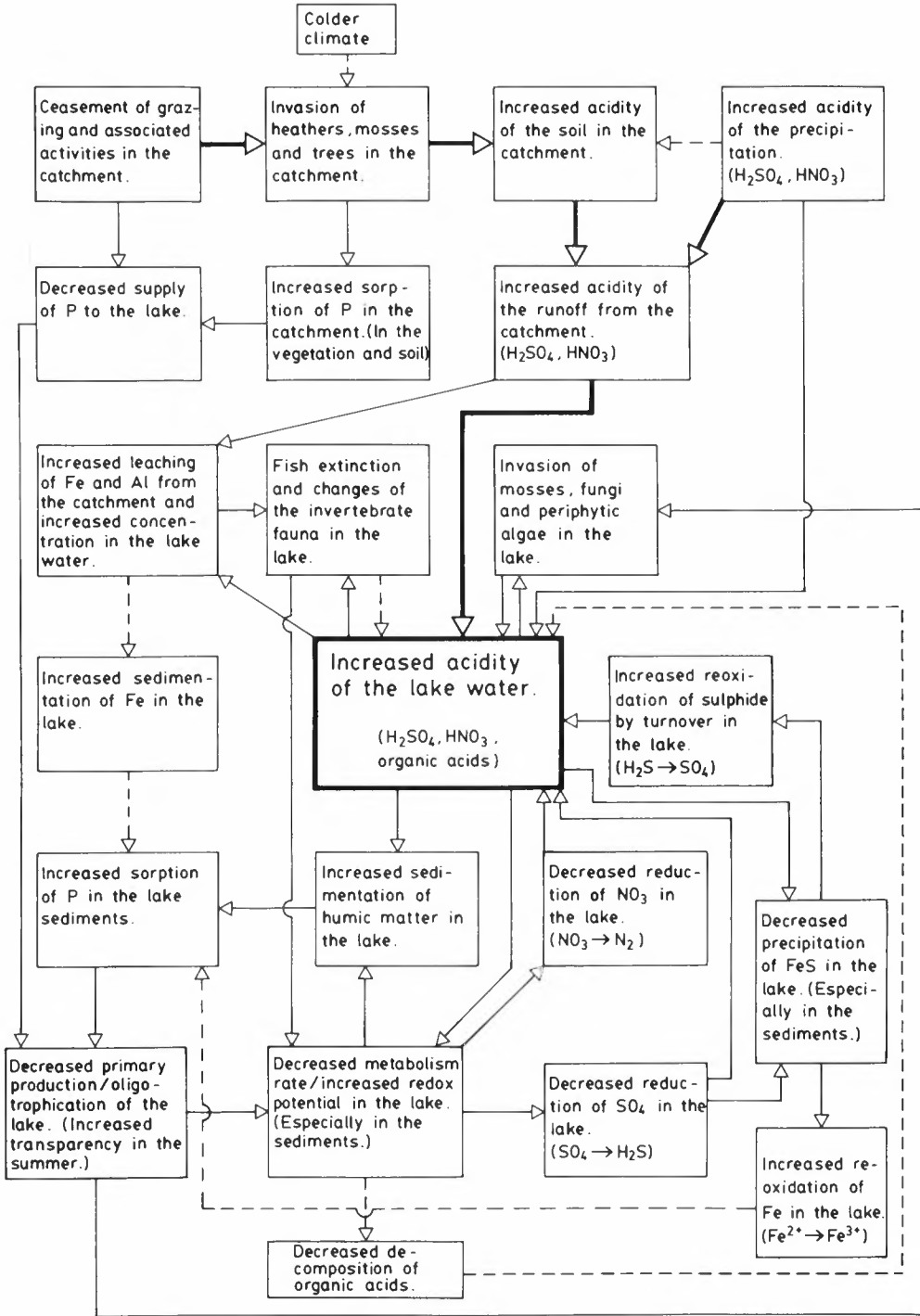

Fig. 126. Conceptual model of lake acidification. Heavy, thin and broken arrows depict strong, small and uncertain effects, respectively.

feasibility decreases with reduced pH. According to simple experiments by the author, the solubility of humic matter decreases with an increased acidity (see also Gjessing 1976). The decreased metabolism rate may increase the amount of undecomposed humic matter normally exposed for sedimentation. P is incorporated in the lake sediments by adsorption to the sedimenting humic particles and as an inherent part of the humic matter.

The precipitation of FeS in the lake sediments will prevent iron from re-oxidizing when lake turnover occurs (see e.g. Ohle 1955, Grøterud & Hongve 1980, Kelly et al. 1982, Cook et al. 1986, Davidson & Finlay 1986). This FeS precipitation also seems to be of importance in preventing the re-oxidation of sulphide to sulphate, which is a direct acidifying process. The precipitation of FeS is affected by two processes, consisting of decreased reduction of sulphate and increased acidity of the lake water, and may consequently be another key factor in the limnic acidification dynamics. The pH-effect (see Fig. 120) may be involved in a feed-back mechanism. However, the supposed long term production of organic S from the sulphide formed (Rudd et al. 1986) makes the situation somewhat unclear.

Nitrate may also take part directly in the acidifying process by decreased reduction to inactive gasses ( $N_2$ ) normally escaping to the atmosphere. Indirectly the presence of  $NO_3$  will provide a relatively high redox potential in the lake water, and possibly the sediments, and will prevent  $SO_4$  from being reduced. Consequently, by a continual increase in  $NO_3$  emission and  $SO_4$  reduction, this part of the model will be of growing importance in the future.

Biological changes like fish extinction and a different community structure of the invertebrate fauna in the lake may affect both the metabolism rate and possibly the lake acidity directly by a decreased rate of base release. These changes are induced by the increased leaching of Al from the catchment and the increased acidity of the lake water. In addition, invasion by mosses, fungi and periphytic algae is involved in a feedback process with the acid lake water. This invasion may also be affected by increased transparency in the lakes. Changes in the decomposition of organic acids will possibly affect lake acidity. However, these mechanisms are at present not well known. But, as shown in the model, the author has ventured to indicate a possible effect.

In general, limnic acidification with its many possible feedback mechanisms is liable to be less stable than the two other main acidification processes (atmospheric and terrestrial). For example, a change in the vegetation cover of the terrestrial catchment may induce a feed-back mechanism in the limnic system, thus giving rise to a stronger acidification than it should merit alone. It is also of interest that acidification of lakes is not necessarily only initiated by an increased supply of acids, but also by, for example, a decreased supply of P.

Although this model describes the acidification dynamics of lakes in Finnemarka, southern Norway, the processes, interactions and feed-back mechanisms should also be of general importance. E. g. the indicated processes and mechanisms contributing to acidification of Lake Gårdsjøen (Nilsson 1985) and to water acidification more generally (Schnoor & Stumm 1985) partly support these considerations.

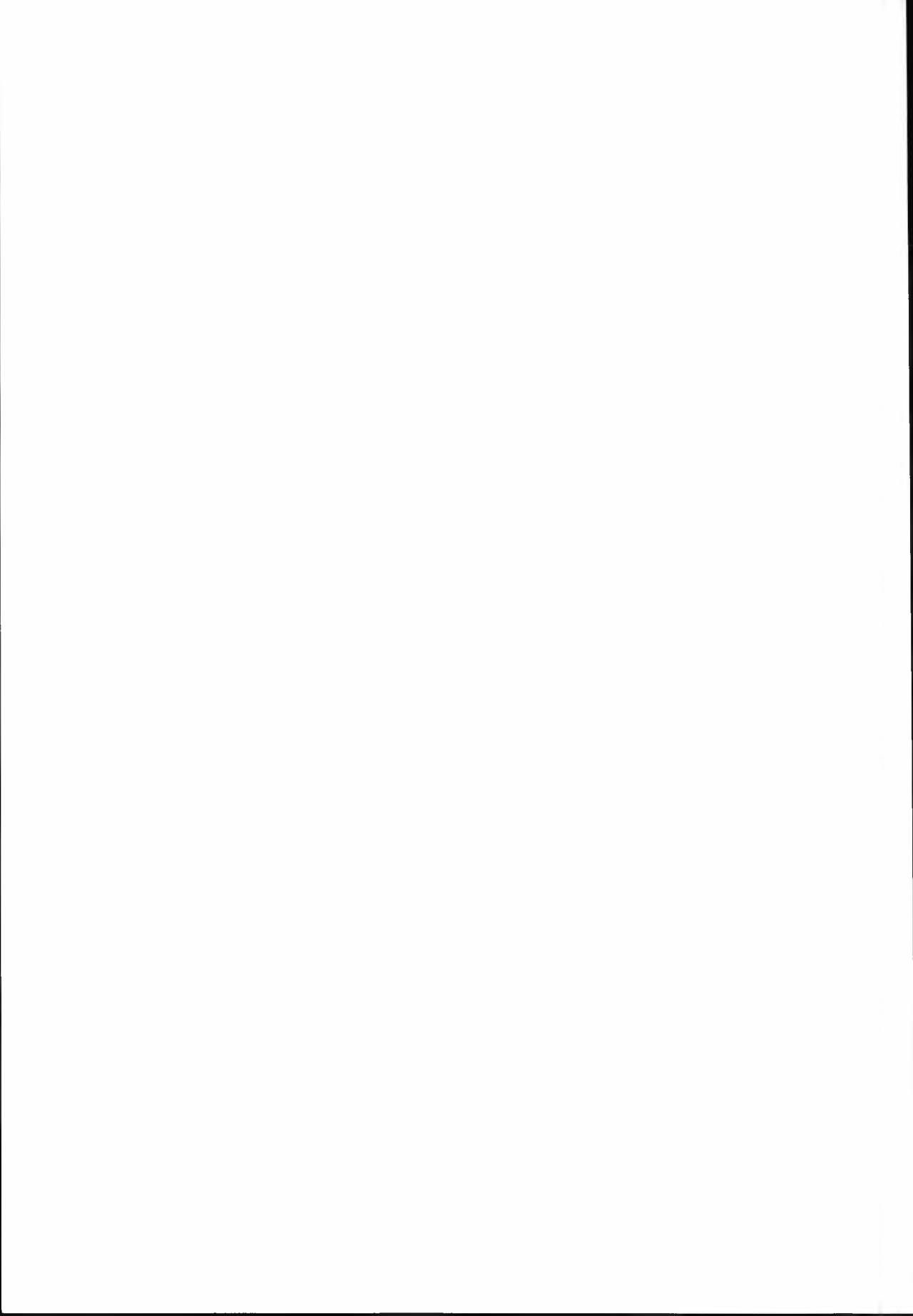



### XIII. CONCLUDING REMARKS

The acidification problem was in the beginning mainly connected to acid precipitation, especially by the researchers in the Norwegian project «Acid Precipitation Effects on Forest and Fish» (SNSF 1976, 1977). In light of this, the crass, but mainly constructive criticism by Rosenqvist (Grøterud 1977), who related acidification primarily to biogeochemical changes in the terrestrial catchments (Rosenqvist 1977, 1981, 1987, Rosenqvist et al. 1980), seems to have been favourable for the water pollution science. Sørensen (1980, 1981a, b, 1982) has also contributed a constructive criticism of acidification research in general and the SNSF-research in particular. Today the researchers in the SNSF-project say that acidic precipitation is *the main* reason for *regional acidification* (Overrein et al. 1980).

The author partly agrees with the two above-mentioned critical scientists, and has in addition introduced the concept of limnic acidification (Grøterud 1981, 1982a, 1984a), which has been important in the present paper. The dynamics of acidification seem more complex than many scientists seem to believe. It is, for example, important to be aware of the probably many unknown interactions and feed-back mechanisms. The three acidification phenomena, atmospheric, terrestrial and limnic (Grøterud 1981, 1984a), may have been in effect at least for many hundreds of years, but their importance has changed during history. For example Rosenqvist (1987) has shown a decrease in pH in a lake around 1400-1450, the time of the Great Plague in Norway (1349-1350), by analysing vanadium and chromium in the sediments. The pH decrease has been explained by the change in the terrestrial vegetation following the cessation of grazing and other activities in the catchment. According to this view, the lake acidification in recent time has been especially strong and more noticeable than previously due to the simultaneity in the three acidification phenomena described.

Finally, a paradox concerning the general water pollution situation could be mentioned. Presupposing limnic acidification, modern silviculture, which has taken over from the older grazing agriculture, may have contributed to acidification in the outfields (due to reduced P supply) and eutrophication in the central areas (due to increased P supply, including the amount reduced in the outfields).

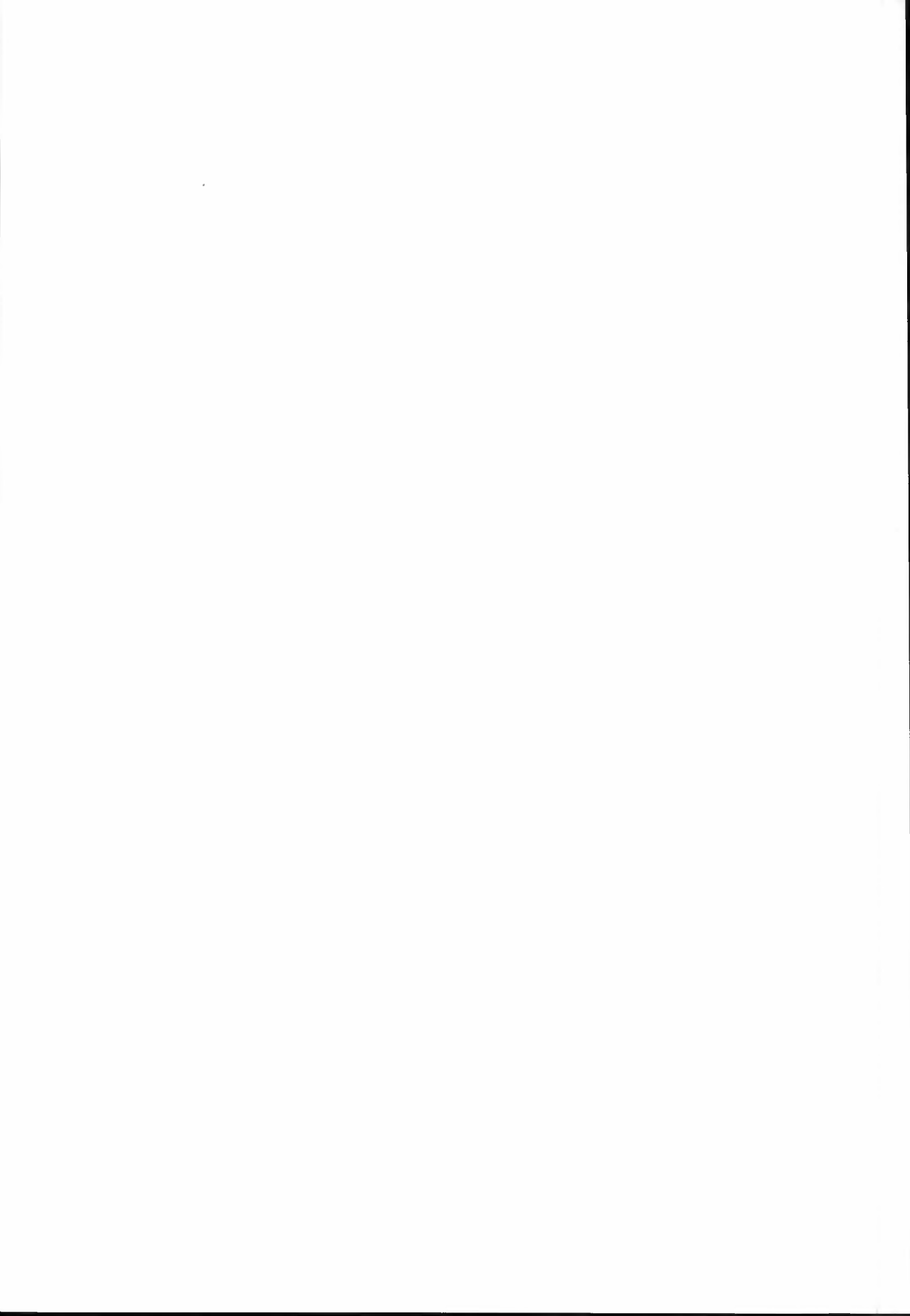

#### XIV. SUMMARY

The paper is introduced by a general description of important pathways and physical, chemical and biological processes in the hydrological cycle, especially concerning acidification. Further, the reasons for water acidification have been discussed by presenting existing views and models.

One neutral and 14 acid lakes have been investigated during 1970-82. Some reference lakes, not discernibly acid, have also been roughly studied, especially with respect to the sediments. The main lakes are typical soft-water lakes lying in an area underlain by granitic rocks with very shallow overburden, i.e. a so-called sensitive area with poor neutralizing capacity of the lakes and their catchments. The area has previously been used for animal grazing and associated activities which today have come to an end, as evidenced by the development of the vegetation in the catchments. Heathers, mosses and trees have invaded at the expense of grass species, especially in the vicinity of abandoned mountain farms. The lakes have shown varying morphometry, e.g. with land/water area ratios from 1.4 to 22.9, lake surface area from 1075 to 314000 m<sup>2</sup> and maximum lake depth from 2.0 to 34.0 m.

The precipitation analyses have shown about the same parameter values as otherwise recorded in southeastern Norway. Hydronium is the major cation (ca. 40 µeq/l) and sulphate the major anion (ca. 60 µeq/l). The acidity of the precipitation during the research period has roughly levelled off. Analyses have also been made of snow and ice profiles and the results have revealed stratification in the concentration of important components.

The chemistry of the micro-drainage and runoff from minicatchments has been analysed to throw light on the terrestrial influence on the drainage water. The water movements have shown to be primarily in the humic layers in the beginning of snow melt or heavy rain with brown acid water, and later also in mineral soils with less brown acid water. The data indicate that the terrestrial catchment regulated the hydronium concentration in the drainage by about 75 %.

The hydrology has been relatively thoroughly investigated, and results bear witness to a typical continental water regime. In concordance with the geology and overburden the hydrology has shown to be relatively clear, with a reasonable water balance and probably small amounts of ground water. The annual runoff from the lakes has shown a close connection to the precipitation measured permanently in the lowland about 10 km southwest of the research area. The hydraulic retention time and loading of the lakes have shown values of 0.2-2.5 years and 1.5-15.5 m/year respectively. These data have been calculated by using standard (normal) runoff values determined in a somewhat unusual way.

Field and laboratory experiments have been performed in order to elucidate a wide specter of hydronium production and consumption sources. Addition of NaOH and ice to minicatchments, lysimeter experiments in the laboratory with top soils and storing of percolation water and stones in distilled water have been given as examples of possible hydronium production processes. Water boatmen (*Corixidae*) have been mentioned as an example of a possible hydronium consumption source, and interaction experiments with undisturbed water-sediment cores and lake fertilization as examples

of both possible hydronium production and consumption. These findings cannot, however, be transferred to natural conditions without reservation.

The lake water chemistry has been examined, among other things, by means of a correlation matrix which indicates a close relationship between important lake water parameters. Multiple correlation analyses by stepwise procedure have given some interesting regression models.

On the basis of input-output measurements and calculations and sedimentation trap measurements the lake retention of various substances has been estimated. The input-output measurements have been considered in relation to substance loading and hydraulic loading and retention time. The trap measurements have been considered in relation to hydraulic loading and retention time, the ratio between the terrestrial catchment and lake area, relative depth and the catchment's drainage potential. These considerations have shown interesting patterns elucidated by «discussion curves».

In attempting to clarify the lakes' acidification history, relatively thorough investigations of the lake sediments have been carried out. Due to many uncertainties in the sampling and analyses the interpretation of the results has not been easy. However, there are indications of interesting sediment changes along with acidification. This has been revealed by comparing acid and non-acid lake sediments. The most questionable aspect of such sediment examinations is the fact that the sediments have been affected by several processes after formation.

The lake retention measurements have been used to calculate the alkalinity budgets for important lake water ions. These calculations have shown, among other things, possible  $\text{SO}_4$  and  $\text{NO}_3$  reduction, and some unknown alkalinity production, possibly connected to neutralization (decomposition) of some humic acids.

A modified Vollenweider model has been used to estimate the P change necessary for a significant change in the primary production in the lakes. This model indicated that there was possibly a higher P supply to the lakes in previous time, with a consequently higher primary production. Higher primary production is assumed in turn to favour alkalinity production, e.g. by increasing the reducing power in the lakes, especially in the sediments.

By focusing on the link between humic matter (humic acids) - fish - alkalinity production in lakes, a tentative conceptual model of humic matter transformation has been put forward. On this basis, the hypothesis that disappearance of fish in acid-sensitive lakes may accelerate the acidifying process has been suggested.

Finally, a conceptual model of lake acidification has been presented. This model is a result of research data, observations, interviews, pictures and calculated guesses.

## XV. ACKNOWLEDGEMENTS

Sincere thanks to all who have helped with this comprehensive and interdisciplinary research. A special thank goes to late Professor Dr. Nils Andreas Sørensen for encouragement during my study, to cand.agric. Knut Mundal for help with data analysis and cand.real. Dag Hongve for critical reading of the manuscript. The Department of Hydrotechnics, Agricultural University of Norway has given considerable indirect support through technical assistance, equipment, etc., and the Norwegian Research Council for Science and Humanities and the Agricultural Research Council of Norway has given direct financial support to respectively the research activity and the printing of the manuscript. Linda Hjeljord has helped with the English and Karin Smisetfoss with the computer preparation of the manuscript.

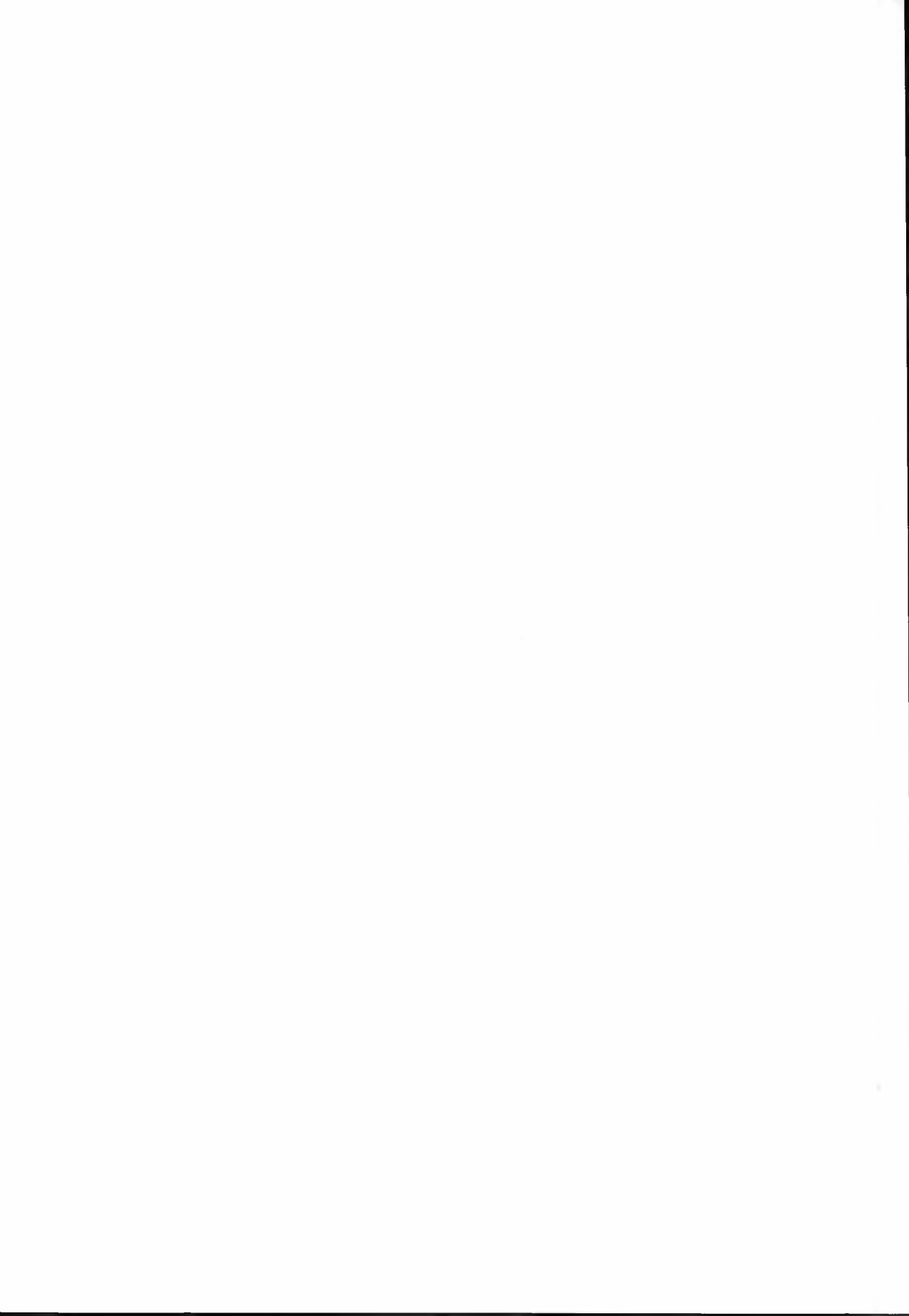

## XVI. REFERENCES

- Abrahamsen, H. D. Hongve, A. Hindar & O.K. Skogheim 1983. Omsetning og sedimentasjon av organisk materiale og tungmetaller i Tyrifjorden 1979. Tyrifjordutvalget 1983. Fagrapport nr. 21. 72 p.
- Adams, W.P., M.C. English & D.C. Lasenby 1979. Snow and ice in the phosphorus budget of a lake in South Central Ontario. *Wat. Res.* 13: 213-215
- Almer, B., W. Dickson, C. Ekstrøm & E. Hørnstrøm 1978. Sulfur pollution and the aquatic ecosystem. In: Nriagu, J.O. (ed): *Sulfur in the environment, Part II, Ecological Impacts*, John Wiley & Sons: 271-311
- Alsaker-Nøstdahl, B.S. 1976. *Jordsmonnet i Drammen «Nordmark»*. Unpublished graduation paper at the University of Oslo. 141 p.
- American Public Health Association 1962. *Standard methods for the examination of water and wastewater* (New York). 626 p.
- Anderson, G., S. Fleischer & W. Granéli 1978. Influence of acidification on decomposition processes in lake sediments. *Verh. int. Verein. Limnol.* 20: 802-807.
- Andersson, B. I. 1985. Properties and chemical composition of surficial sediments in the acidified Lake Gårdsjön, SW Sweden. *Ecol. Bull. (Stockholm)* 37:251-262.
- Andersson, F. & B. Olsson (eds.) 1985. *Lake Gårdsjön. An acid forest lake and its catchment*. *Ecol. Bull. (Stockholm)* 37:1-336.
- Andersson, G. & G. Gahnstrøm 1985. Effects of pH on release and sorption of dissolved substances in sediments-water microcosmos. *Ecol. Bull. (Stockholm)* 37:301-318.
- Andersson-Calles, U.M. & E. Eriksson 1979. Mass balance of dissolved inorganic substances in three representative basins in Sweden. *Nord. Hydrol.* 10: 99-114.
- Baalsrud, K., A. Hindar, M. Johannessen & D. Matzow 1985. *Kalking av surt vann. Kalkingsprosjektet, sluttrapport Miljøverndepartementet-Direktoratet for vilt og ferkvannsfisk*. 145p.
- Baas, D.S. & M.M. Boucherle 1984. Changes in Cladocera community structure and fossil pigment stratigraphy as compared to the fire history of Elk Lake, Clearwater Co., MN, U.S.A. *Verh. int. Verein. Limnol.* 22: 1366-1371.
- Bengtsson, L. & S. Fleischer 1971. *Sedimentundersökningar i sjöarna Trummen och Hinnasjön 1968-1970*. *Vatten* 22: 73-94.
- Berge, D. 1982. *Resipientundersøkelse i Førsvatn. Vurdering av utslipp fra et planlagt turistsenter*. NIVA-rapport 0-81060. 17 p.
- Bergseth, H. 1977. Relationen zwischen Acidität und Vegetationstyp norwegischer Waldböden. *Acta Agric. Scand.* 27: 269-279.
- Bick, H. & E.F. Drews 1973. *Selbstreinigung und Ciliatenbesiedlung in saurem Milieu (Modellversuche)*. *Hydrobiologia* 42: 393-402.
- Bjerke, G., A.H. Erlandsen & K. Vennerød 1977. *Sedimentasjon i Eikeren*. *Vann*: 258-264.
- Bjerve, L. 1981. *Forurensninger i et landbruksområde, Ringsaker kommune, Hedmark*. Sluttrapport Institutt for hydroteknikk, NLH. 15 p.
- Bjerve, L. & O. Grøterud 1980. *Discharge-Measurements by a New- Formed Relative Salt Dilution Method in Small Turbulent Streams*. *Nord. Hydrol.* 11: 121-132.
- Bloesch, J. 1974. *Sedimentation und Phosphorhaushalt im Vierwaldstättersee (Horwer Bucht), und im Rotsee*. *Schweiz. Z. Hydrol.* 36: 1-208.

- Bloesch, J. & N.M. Burns 1980. A critical review of sedimentation trap technique. *Schweiz. Z. Hydrol.* 42: 15-55.
- Brakke, D.F. 1984. Acidification history and prediction using biological indices. *Verh. int. Verein. Limnol.* 22: 1391-1395.
- Bryon, E.R. & P. Eloranta 1984. Recent historical changes in the diatom community of Lake Tahoe, California-Nevada, U.S.A. *Verh. int. Verein. Limnol.* 22:1372-1376.
- Brown, S.R., H.J. McIntosh & J.P. Smol 1984. Recent paleolimnology of a meromictic lake: Fossil pigments of photosynthetic bacteria. *Verh. int. Verein. Limnol.* 22: 1357-1360.
- Brown, L. & E.G. Bellinger 1978. Nitrate determination in fresh and some estuarine waters by ultraviolet light absorption: a new proposed method. *Wat. Res.* 11: 223-229.
- Brække, F.H. 1981. Hydrochemistry in low-pH-soils of South Norway. 1. Peat and soil water quality. *Meddr nor. inst. Skogforsk.* 36 (11): 1-32.
- Brække, F.H. 1982. Svovelkretsløpet i myr og mineraljord. *Miljønytt Miljøverndepartementet Oslo*, nr. 1:22.
- Bøyum, A. 1976. Limnology and Paleolimnology of Lake Nordvann, South-Eastern Norway. *Arch. Hydrobiol.* 70: 277-324.
- Carignan, R. & A. Tessier 1985. Zinc deposition in acid lakes: the role of diffusion. *Science* 228: 1524-1526.
- Charles, D.F. & S.A. Norton 1986. Paleolimnological Evidence for Trends in Atmospheric Deposition of Acids and Metals. In: James Gibson (ed.): *Acid Deposition. Long-Term Trends.* National Academy Press. Washington, D.C.: 335-431.
- Chen, R.L., D.R. Keeney & J.G. Konrad 1972. Nitrifications in lake sediments. *J. Envir. Quality* 7: 751-154.
- Christophersen, N. 1983. Freshwater acidification - a modelling approach. Doctoral dissertation, University of Oslo. 42 p. + Appendix.
- Cole, G.A. 1975. *Textbook of Limnology.* The C.V. Mosby Company. St. Louis. 283 p.
- Cook, R.B., C.A. Kelly, D.W. Schindler & M.A. Turner 1986. Mechanisms of hydrogen ion neutralization in an experimentally acidified lake. *Limnol. Oceanogr.* 31: 134-148.
- Daugan, W.K. & A.L. Wilson 1974. The absorptiometric determination of aluminium in water. A comparison of some chromogenic reagents and the development of an improved method. *Analyst* 99: 413-430.
- Davidson, W. & B. J. Finlay 1986. Ferrous iron and phototrophy as alternative sinks for sulphide in the anoxic hypolimnia of two adjacent lakes. *J. Ecol.* 76:663-673.
- Davis, R.B. & F. Berge 1980. Atmospheric deposition in Norway during the last 300 years as recorded in SNSF lake sediments. II. Diatom stratigraphy and inferred pH. In: Drabløs, D. & A. Tollan (eds.): *Ecological impact of acidprecipitation, SNSF-project:* 270-271.
- DeCosta, J. & C. Preston 1980. The phytoplankton productivity of an acidic lake. *Hydrobiologia* 70:39-49.
- de March, L. 1975. Nutrient budgets for a high arctic lake (Char Lake, N.W.T) *Verh. int. Verein. Limnol.* 19:496-503.
- Dickman, M. & J. Fortescue 1984. Rates of lake acidification inferred from sediment diatoms for 8 lakes located north of Lake Superior, Canada. *Verh. inst. Verein. Limnol.* 22:1345-1356.
- Dickson, W. 1975. Acidification of Swedish lakes. Institute of Freshwater Research, Drottningholm, Sweden. Rep. no. 54: 8-20.
- Dillon, P. J., D.S. Jefferies & W. A. Scheider 1982. The use of calibrated lakes and watersheds for estimating atmospheric deposition near a large point source. *Wat. Air Soil Pollut.* 18:241-258.



- Dillon, P. J., N.D. Yan, W.A. Schneider & N. Conroy 1979. Acid lakes in Ontario, Canada: Characterization, extent and responses to base and nutrient additions. *Arch. Hydrobiol. Beih. Ergeb. Limnol.* 13: 317-336.
- Driscoll jr., C.T., J. P. Baker, J. J. Bisogni jr. & C. L. Schofield 1980. Effects of aluminium speciation on fish in dilute, acidified waters. *Nature* 284: 161-164.
- Dunnette, D. A., D. P. Chynoweth & K. H. Mancy 1985. The source of hydrogen sulfide in anoxic sediment. *Wat. Res.* 19:875-884.
- Englund, J.O. 1980. *Generell hydrogeologi*. Landbruksbokhandelen Ås-NLH. 136 p.
- Foster, P. & G.M. Foster 1977. Ultra-violet absorption characteristics of waters in an industrialized estuary. *Wat. Res.* 11: 351-354.
- Frey, D.G. 1974. Paleolimnology. *Mitt. int. Verein. Limnol.* 20: 95-123.
- Gaarder, T. 1915-16. De vestlandske fjorders hydrografi. *Bergens Mus. Årsberetn.* 1915-16: 25-37.
- Gahnström, G. 1985. Sediment oxygen uptake in the acidified Lake Gårdsjön, Sweden. *Ecol. Bull. (Stockholm)* 37:276-286.
- Gahnström, G. & S. Fleischer 1985. Microbial glucose transformation in sediment from acid lakes. *Ecol. Bull. (Stockholm)* 37:287-292
- Gjessing, E.T. 1976. *Physical and Chemical Characteristics of Aquatic Humus*. Ann. Arbor. Science Publishers, Inc. Michigan, U.S.A. 120 p.
- Gjessing, E.T., M. Johannessen & R.F. Wright 1976. Effects of acid precipitation on freshwater chemistry. In: Brække, F.H. (ed.): *Impact of Acid Precipitation on Forest and Fresh water Ecosystems in Norway*. SNSF-project FR6: 65-85.
- Golterman, H.L. 1969. *Methods for chemical analyses of fresh waters*. IBP handbook no. 8. 172 p.
- Gorham, E. 1960. Chlorophyll derivatives in surface muds from the English lakes. *Limnol. Oceanogr.* 5: 29-33.
- Gorham, E. 1961. Chlorophyll derivatives, sulphur, and carbon in sediment cores from two English lakes. *Can. J. Bot.* 39: 333-338.
- Gorham, E., S. J. Eisenreich, J. Ford & M. V. Santelmann 1985. The chemistry of bog waters. In: Stumm, W. (ed): *Chemical processes in lakes*. John Wiley & Sons. New York, Chichester, Brisbane, Toronto, Singapore: 339-363.
- Gorham, E. & J.E. Sanger 1964. Chlorophyll derivatives in woodland swamp and pond soils of Cedar Creek Natural History Area, Minnesota, U.S.A. In: Miyake, Y & T. Royama (eds.): *Recent researches in the fields of hydrosphere, atmosphere and nuclear geochemistry*. Maruzen Co. Ltd., Tokyo: 1-12.
- Gorham, E. & J.E. Sanger 1967. Plant pigments in woodland soils. *Ecology* 48: 306-308.
- Gorham, E. & J.E. Sanger 1972. Fossil pigments in surface sediments of a meromictic lake. *Limnol. Oceanogr.* 17: 618-622.
- Gorham, E., J.W. Lund, J.E. Sanger & W.E. Den jr. 1974. Some relationship between algal standing crop, water chemistry, and sediment chemistry in the English Lakes. *Limnol. Oceanogr.* 19: 601-617.
- Grahn, O., H. Hultberg & L. Landner 1974. Oligotrophication - a self-accelerating process in lakes subjected to excessive supply of acid substances. *Ambio* 3: 93-94.
- Granéli, W. 1977. Measurement of sediment oxygen uptake in the laboratory using undisturbed sediment cores. *Vatten* 33: 251-263.

- Grøterud, O. 1971a. Oksygenmetermålinger in situ. Resultater i forhold til Winkler-metoden. *Vatten* 27: 246-252.
- Grøterud, O. 1971b. In situ determinations of pH in some lakes. *Nord. Hydrol.* 2: 133-145.
- Grøterud, O. 1972a. Ice analyses. Data from three Norwegian lakes. *Hydrobiologia* 49: 371-391.
- Grøterud, O. 1972b. Hydrographical data from two soft water lakes with special reference to precipitation (melt water). *Arch. Hydrobiol.* 70: 277-324.
- Grøterud, O. 1972c. Zooplankton and fish in relation to acid melt water and anaerobic deep water in a lake. *Vatten* 28: 329-332.
- Grøterud, O. 1973. Noen sure innsjøer i Norge. *Vatten* 29: 153-158.
- Grøterud, O. 1977. Rosenqvist-rapporten om sur nedbør må tas alvorlig. *Aftenpostens aftenutgave*, 6th January.
- Grøterud, O. 1978. Cryochemistry of lakes with special reference to formation, distribution, and effect of phosphorus and hydronium. A preliminary report. *Verh. int. Verein. Limnol.* 20: 758-764.
- Grøterud, O. 1981. The dynamics of acidification from a new view elucidated by studies in a lake area in Norway. *Verh. int. Verein. Limnol.* 21: 406-411.
- Grøterud, O. 1982a. Limnisk forsurening med vekt på sedimentene. Foredrag på seminar om «Surhet som miljøproblem i vassdrag,» arrangert av Norsk Limnologforening 19. Mars. Summary.
- Grøterud, O. 1982b. Hydroniumproduksjon ved begroing av perifyton i ferskvann. Foredrag på seminar om «Sur nedbør» arrangert av NIVA og SI 6.-7. Desember. Abstract.
- Grøterud, O. 1984a. A conceptual model of lake acidification. *Verh. int. Verein. Limnol.* 22: 686-691.
- Grøterud, O. 1984b. Surhet og humusfarge i en regulert innsjø. Norsk hydrologisk komite'. Rapport nr. 17: 195-203.
- Grøterud, O. 1985. Omsetninger - hydrologi, hydrokemi. I: Eie, J.A. (red.): *Forsuring. Årsaker, virkninger og tiltak*. Tapir: 30-53.
- Grøterud, O. 1986. Fordunstning i relasjon til plantetetthet, vanning og fordunstning fra en fri vannflate. Et pilotforsøk. Rapport 1. Institutt for hydroteknikk. 9 p.
- Grøterud, O. 1987. Water pathways and acid runoff from small catchments underlain by granitic rocks with no or shallow overburden. In: *The Norwegian National Committee for Hydrology in co-operation with Unesco and WMO, the IHP National Committees of Denmark, Finland and Sweden (eds.): Acidification and Water Pathways. Vol II: 33-40.*
- Grøterud, O. In prep. UV-absorpsjonskarakteristikker brukt i vannkvalitetsvurderinger.
- Grøterud, O. & D. Hongve 1980. Innsjøsedimentenes buffernivå og kapasitet mot forsurening. *Vann* 15: 116-121.
- Gulbrandsen, T.R. 1980. Oksygenforbruk i sedimenter og relaterte parametre. Unpublished graduation paper at the University of Oslo. 144 p.
- Halvorsen, K. 1977. Makrofyttvegetasjonen i endel vann i Agder. SNSF-projekt, TN 36/77. 154 p.
- Hansen, K. 1962. The dystrophic lake type. *Hydrobiologia*. 19: 183-191.
- Hegna, K. 1986. Sammenlikning av vann- og sedimentkjemi mellom et 6-9 år gammelt skogbrannområde og et ikke-brent skogsområde i Telemark. Unpublished graduation paper at the University of Oslo. 123 p.
- Hendry, G.R., K. Baalsrud, T. Traaen, M. Laake & G. Raddum 1976. Acid precipitation. Some hydrobiological changes. *Ambio* 5-6: 224-227.

- Hendry, G.R. & F. Vertucci 1980. Benthic plant communities in acidic Lake Colden, New York: Sphagnum and the algal mat. In: Drabløs, D. & A. Tollan (eds.): Ecological impact of acid precipitation. SNSF-project: 314-315.
- Henriksen, A. 1980. Acidification of freshwaters - a large scale titration. In: Drabløs, D. & A. Tollan (eds.): Ecological impact of acid precipitation. SNSF-project: 68-74.
- Henriksen, A. 1982. Chemistry of Freshwaters. An Empirical Model for Lake Acidification. Doctoral dissertation University of Oslo: 1-25 + Appendix.
- Henriksen, A. & R.F. Wright 1977. Effects of acid precipitation on a small acid lake in southern Norway. Nord. Hydrol. 8: 1-10.
- Hobæk, A. & G.G. Raddum 1980. Zooplankton communities in acidified regions of South Norway. SNSF-project, IR 75/80. 132 p.
- Holtedahl, O. 1960. Norges geologi. Norg. geol. Unders. No 208.540 p.
- Hongve, D. 1978. Buffering of acid lakes by sediments. Verh. int. Verein. Limnol. 20: 743-748.
- Hongve, D. & A.H. Erlandsen 1979. Shortening of surface sediment cores during sampling. Hydrobiologia 65: 283-287.
- Hultberg, H. 1985. Budgets of base cations, chloride, nitrogen and sulphur in the acid Lake Gårdsjön catchment, SW Sweden. Ecol. Bull. (Stockholm) 37:133-157.
- Hultberg, H. & I. Andersson 1982. Liming of acidified lakes and streams - aspects on induced physical-chemical and biological changes. Wat. Air Soil Pollut. 18: 311-331.
- Hutchinson, G.E. 1957. A treatise on limnology. I: Geography, Physics and Chemistry. New York, London. 1015 p.
- Hørnstrøm, E. & C. Ekstrøm 1983. pH-nærings- og aluminiums effekter på plankton i västkustsjar. Statens naturvårdsverk rapport, SNV PM 1704. 124 p.
- Håkanson, L. 1981. Sjøsedimenten i resipientkontrollen. Prinsipper, prosesser och praktiske exempel. SNV PM 1398. 242 p.
- Jansson, M. 1979. Nutrient budgets and the regulation of nutrient concentrations in a small sub-arctic lake in northern Sweden. Freshwat. Biol. 9: 213-231.
- Jenny, H. 1941. Factors of soil formation. A system of quantitative pedology. New York and London. 281 p.
- Jenny, H. 1961. Comparison of soil nitrogen and carbon in tropical and temperate regions. Missouri Agricultural Experimental Station Research Bulletin 765: 5-31.
- Jensen, H.S. 1983. Sulfate reduction and oxygen uptake in the sediment of the shallow, eutrophic Lake Arreskov. 11th Nordic Symposium on Sediments, March 10-13, 1983, Finse, Norway. Norsk Limnologforening: 126-141.
- Johannessen, M. & A. Henriksen 1978. Chemistry of snow melt water. Changes in concentrations during melting. Wat. Res. 14: 615-619.
- Johannessen, M., A. Skartveit & R.F. Wright 1980. Streamwater chemistry before, during and after snowmelt. In: Drabløs, D. & A. Tollan (eds.): Ecological impact of acid precipitation. SNSF-project: 224-225.
- Johannessen, M., A. Lande & S. Rognerud 1984. Fertilization of 6 small mountain lakes in Telemark, Southern Norway. Verh. int. Verein. Limnol. 22: 673-678.
- Jordan, M. & G.E. Likens 1975. An organic carbon budget for an oligotrophic lake in New Hampshire, U.S.A. Verh. int. Verein. Limnol. 19: 994-1003.

- Juday, C. & E.A. Birge 1932. Dissolved oxygen and oxygen consumed in the lake waters of northeastern Wisconsin. *Trans. Wis. Acad. Sci. Arts. Lett.* 27:415-486.
- Kahl, J.S. & S.A. Norton 1983. Metal input and mobilization in two acid-stressed lake watersheds in Maine: Completion Report, Project A-053-ME. Land and Water Resources Center, University of Maine. 70 p.
- Kelly, C.A., J.W. M. Rudd & D.W. Schindler 1982. The potential importance of bacterial processes in regulating rate of lake acidification. *Limnol. Oceanogr.* 27: 868-882.
- Kilham, P. 1982. Acid precipitation: Its role in the alkalization of a lake in Michigan. *Limnol. Oceanogr.* 27: 856-867.
- Kjensmo, J. 1968. Late and post-glacial sediments in the small meromictic Lake Svinsjøen. *Arch. Hydrobiol.* 65:125-141.
- Kjensmo, J. 1978. Postglacial sediments in Vilbergstjern, a small meromictic kettle lake. *Pol. Arch. Hydrobiol.* 25: 207-216.
- Laake, M. 1976. Effekter av lav pH på produksjon, nedbrytning og stoffkretsløp i littoralsonen. SNSF-project, IR 29/76. 75 p.
- Lande, A., M. Johannessen, S. Rognerud, A. Moksnes & Ø. Skar 1980. Gjødsling av fiskevann. Bakgrunnsdata fra 18 innsjøer i Telemark. Framdriftsrapport nr. 1, Skrifter TDH 54: 1-57.
- Lyden, A. & O. Grahn 1985. Phytoplankton species composition, biomass and production in Lake Gårdsjön-an acidified clearwater lake in SW Sweden. *Ecol. Bull. (Stockholm)* 37:195-202.
- Lynn, D.G. & E. Bonatti 1965. Mobility of manganese in diagenesis of deep-sea sediments. *Mar. Geol.* 3: 457-475.
- Lönnerblad, G. 1930. Über die Sauerstoffabsorption des Boden substrats in einigen Seentypen. *Bot. Notiser*, 1930: 53-60.
- Lönnerblad, G. 1931. Über die Sauerstoffabsorption der dystrophen Seen. *Acta Univ. Lund, NF Avd.*, no. 14. 53 p.
- Mackereth, F. J. H. 1963. Water Analysis for Limnologists. *Freshwat. Biol. Ass. sci. Publs.* 21. 70 p.
- Mackereth, F. J. H. 1966. Some chemical observations on post-glacial lake sediments. *Phil. Trans. R. Soc. London* 250: 165-213.
- Mayer, L.M., F.P. Liotta & S.A. Norton 1982. Hypolimnetic redox and phosphorus cycling in hypereutrophic Lake Sebasticook, Maine. *Wat. Res.* 16: 1189-1196.
- Mitchell, M. J., M. B. David & A. J. Uutala 1985. Sulfur distribution in lake sediment profiles as an index of historical depositional patterns. *Hydrobiologia* 121:121-127.
- Mohn, E., E. Joranger & R.F. Wright 1980a. De regionale vannundersøkelsene 1975-78. En statistisk bearbeidelse. SNSF-project, IR 62/80. 69 p.
- Mohn, E., E. Joranger, S. Kalvenes, B. Sollie & R.F. Wright 1980b. Regional surveys of the chemistry of small Norwegian lakes: A statistical analysis of the data from 1977-78. In: Drabløs, D. & A. Tollan (eds.): Ecological impact of acid precipitation. SNSF-project: 234-235.
- Mortimer, C.H. 1941-42. The exchange of dissolved substances between mud and water in lakes. *J. Ecol.* 29: 280-329, 30: 147-201.
- Mossberg, P. & P. Nyberg 1979. Bottom fauna of small acid forest lakes. Institute for Freshwater Research. Drottningholm, Report 58: 77-87.
- Mothes, G. 1981. Sedimentation und Stoffbilanzen in Seen des Stechlinseegebiets. *Limnologica (Berlin)* 13: 147-194.

- Myhr, E. 1986. Ulike veksters potensielle vassforbruk. Informasjonsmøte teknikk, SFFL, nr. 6: 99-106.
- Nilssen, J.P. 1980. Acidification of a small watershed in southern Norway, and some characteristics of acidic aquatic environments. *Int. Rev. Ges. Hydrobiol.* 65: 177-207.
- Nilsson, S. I. 1985. Why is Lake Gårdsjön acid? - An evaluation of processes contributing to soil and water acidification. *Ecol. Bull. (Stockholm)* 37:311-318.
- Norton, S.A., R.F. Dubiel, D.R. Sasseville & R.B. Davis 1978. Paleolimnologic evidence for increased zinc loading in lakes of New England, USA. *Verh. int. Verein. Limnol.* 20: 538-545.
- Norton, S.A. & C.T. Hess 1980. Atmospheric deposition in Norway during the last 300 years as recorded in SNSF lake sediment. 1. Sediment dating and chemical stratigraphy. *Pro ceedings of International Conference on the Ecological Impact of Acid Precipitation, Sandefjord, Norway:* 268-269.
- Ohle, W. 1940. Chemische Eigenart der smålandsischen Seen. *Verh. int. Verein. theor. angew. Limnol.* 9: 145-159.
- Ohle, W. 1953. Der Vorgang rasanter Seenalterung in Holstein. *Naturwissenschaften* 40: 153-162.
- Ohle, W. 1954. Sulfat als «Katalysator» des limnischen Stoffkreislaufes. *Vom Wass.* 21: 13-32.
- Ohle, W. 1955. Die Ursachen der rasanten Seeneutrophierung. *Verh. int. Verein. theor. angew. Limnol.* 12: 373-382.
- O'Sullivan, P.E., M.A. Coard, S.M. Cousen & D.A. Pickering 1984. Studies of the formation and deposition of annually-laminated sediments in Loe Pool, Cornwall, U.K. *Verh. int. Verein. Limnol.* 22: 1383-1387.
- Otnes, J. & E. Ræstad 1978. Hydrologi i praksis. Ingeniørforlaget, Oslo. 314 p.
- Overrein, L.N., H.M. Seip & A. Tollan 1980. Acid precipitation - effects on forest and fish. Final report on the SNSF project 1972-1980. Research report, FR 19/80. 175 p.
- Penington, W. 1974. Seston and sediment formation in five Lake District Lakes. *J. Ecol.* 62: 215-251.
- Persson, G. & O. Broberg 1985. Nutrient concentrations in the acidified Lake Gårdsjön: The role of transport and retention of phosphorus, nitrogen and DOC in watershed and Lake. *Ecol. Bull. (Stockholm)* 37:158-175.
- Pleym, H. 1978. Miljøklimatologi. Tapir. 115 p.
- Premazzi, G. & G. Marengo 1982. Sedimentation rates in a Swiss-Italian lake measured with sediment traps. *Hydrobiologia* 92: 603-610.
- Raddum, G.G., J. Jastrey, B.O. Rosseland & I. Sevaldrud 1979. Vannteger i Sør-Norge og deres betydning som fiskeføde i vann med ulik pH. SNSF-prosjekt, IR 50/79. 41 p.
- Rainey, R. H. 1967. Natural displacement of pollution from the Great Lakes. *Science* 155:1242-1243.
- Rannem, G. & D. Hongve 1980. Glødetapet i sediment avhenger av organisk materiale og jerninnhold. *Skrifter TDH* 50: 49-56.
- Reissinger, A. 1932. Quantitative Untersuchungen über den Schlammabsatz im Al্পsee, dem Niedersonthofener See und dem Starnberger See. *Arch. Hydrobiol.* 24: 535-542.
- Renaud, A. 1949. A contribution to the study of the glacier grain. *J. Glaciol.* 1: 320-324.
- Renberg, I. 1981. Improved methods for sampling, photographing and varve-counting of varved lake sediments. *Boreas* 10: 255-258.
- Renberg, I. 1985. Influences of acidification on the sediment chemistry of Lake Gårdsjön, SW Sweden. *Ecol. Bull. (Stockholm)* 37:246-250.

- Renberg, I. & T. Hedberg 1982. The pH history of lakes in Sweden as calculated from subfossil diatom flora of the sediments. *Ambio* 1: 30-33.
- Rodhe, W. 1951-52. Kompendium i Limnologi. Fysikaliska och kemiska miljöförhållanden. Limnologiska institutionen Uppsala. 68p.
- Rognerud, S., D. Berge & M. Johannessen 1979. Telemarksvassdraget. Hovedrapport fra undersøkelsene i perioden 1975-79. Arbeidsrapport. Skrifter TDH 38: 1-60.
- Rosenqvist, I.Th. 1977. Sur jord - surt vann. Ingeniørforlaget, Oslo. 123 p.
- Rosenqvist, I. Th. 1981. Betydningen av sur nedbør og sur jord i innsjøkjemi. *Vann* 16: 402-409.
- Rosenqvist, I. Th. 1987. Acidity of surface water in Norway. In: The Norwegian National Committee for Hydrology in cooperation with Unesco and WMO, the IHP National Committees of Denmark, Finland and Sweden (eds.): *Acidification and Water Pathways*. Vol. 1: 223-235.
- Rosenqvist, I. Th., P. Jørgensen & H. Rueslåtten 1980. The importance of natural  $H^+$  -production for acidity of soil and water. In: Drabløs, D. & A. Tollan (eds.): *Ecological impact of acid precipitation*. SNSF-project: 240-242.
- Rudd, J. W.M., C. A. Kelly & A. Furutani 1986. The role of sulfate reduction in long term accumulation of organic and inorganic sulfur in lake sediments. *Limnol. Oceanogr.* 31:1281-1291.
- Rueslåtten, H.G. & P. Jørgensen 1978. Interaction between bedrock and precipitation at temperatures close to 0°C. *Nord. Hydrol.* 9: 1-6.
- Ruttner, F. 1963. *Fundamentals of Limnology*. University of Toronto Press, Toronto and Buffalo. 307 p (with appendix).
- Ryhänen, R. 1968. Die Bedeutung der Humussubstanzen im Stoffhaushalt der Gewässer Finnlands. *Mitt. int. Verein. Limnol.* 14: 168-178.
- Røgeberg, B. (red.) 1982. *Finnemarka*. 239 p.
- Sanger, J.E. & E. Gorham 1972. Stratigraphy of fossil pigments as a guide to the postglacial history of Kirchner Marsh, Minnesota. *Limnol. Oceanogr.* 17: 840-854.
- Sanni, S., O.K. Skogheim & D. Hongve 1984. Sediment - vannundersøkelser i forbindelse med kalking av 3 vann i Gjerstad, Aust-Agder. Kalkingsprosjektet rapport 13. 46 s.
- Schindler, D.W., R.W. Newbury, K.G. Beaty & P. Campbell 1976. Natural water and chemical budgets for a small Precambrian lake in central Canada. *J. Fish. Res. Bd Can.* 33: 2526-2543.
- Schindler, D.W., R. Wagemann, R.B. Cook, T. Ruzczynski & J. Prokopowich 1980. Experimental acidification of Lake 223, experimental lake area: background data and the first three years of acidification. *Can. J. Fish. Aquat. Sci.* 37: 342-354.
- Schindler, D.W., M.A. Turner, M.P. Stainton & G.A. Linsey 1986. Natural Sources of Acid Neutralizing Capacity in Low Alkalinity Lakes of the Precambrian Shield. *Reports, Science* 232: 844-847.
- Schindler, D.W. & J.E. Nighswander 1970. Nutrient supply and primary production in Clear Lake, eastern Ontario. *J. Fish. Res. Bd Can.* 27: 2009-2036.
- Schnoor, J. L. & W. Stumm 1985. Acidification of aquatic and terrestrial systems. In: Stumm, W. (ed.): *Chemical processes in lakes*. John Wiley and Sons. New York, Chichester, Brisbane, Toronto, Singapore: 311-338.
- Sederholm, H., A. Mauranen & L. Montonen 1973. Some observations on the microbial degradation of humus substances in water. *Verh. int. Verein. Limnol.* 18: 1301-1305.

- Segerström, U., I. Renberg & J.-E. Wallin 1984. Annual sediment accumulation and land use history; investigations of varved lake sediments. *Verh. int. Verein. Limnol.* 22: 1396-1403.
- Seip, H.M. 1980. Acidification of freshwater - sources and mechanisms. In: Drabløs, D. & A. Tollan (eds.): *Ecological impact of acid precipitation*. SNSF-project: 358-365.
- Seip, H.M., E.T. Gjessing & H. Kamben 1979. Importance of the composition of the precipitation for the pH in runoff - Experiments with artificial precipitation on partly soil covered «mini-catchments». SNSF-project, IR 47/79. 34 p.
- Seip, H.M., S. Andersen & B. Halsvik 1980. Snowmelt studied in a mini-catchment with neutralized snow. SNSF-project, IR 65/80. 20 p.
- Sheppard, C.R.C. 1977. Problem with the use of ultra-violet absorption for measuring carbon compounds in a river system. *Wat. Res.* 11: 979-982.
- Selmer-Olsen, A.R. 1981. Surhetsvariasjoner som følge av nedtapping av et regulert vann. *Jord og Myr* 79: 13-17.
- Simola, H., P. Huttunen & J. Meriläinen 1984. Varve-dated eutrophication history of a small lake. *Verh. int. Verein. Limnol.* 22: 1404-1408.
- Singh, B.R. 1984. Sulfate sorption by acid forest soils. *Soil Sci.* 138 (3): 189-197, 138 (4): 294-297, 138 (5): 346-353, 138 (6): 440-447.
- Skogheim, O. K. 1976. Recent Hypolimnetic Sediment in Lake Gjørsjøen, a Eutrophicated Lake in SE Norway. *Nord. Hydrol.* 7: 115-134.
- Skogheim, O. K. 1978. Recent sediments in a eutrophicated lake; Årungen, Norway. *Verh. int. Verein. Limnol.* 20: 749-757.
- Skogheim, O. K. 1980. Sedimentation of particulate carbon, nitrogen and phosphorus in Lake Årungen, Norway. In: 8th Nordic Symposium on Sediments. Salten Skov Laboratory, Denmark. Eds.: Andersen, F.Ø., L. Kofod & E. Lastein: 31-40.
- Skogheim, O. K. & A. Erlandsen 1984. The eutrophication of Lake Årungen as interpreted from paleolimnological records in sediment cores. *Vann* 19: 451-463.
- Skogheim, O.K. & D. Hongve 1979. Seston og sedimentasjon i Tyrifjorden 1979. Fagrapport nr. 4 Tyrifjordutvalget. 39 p.
- Smol, J.P., S.R. Brown & H.J. McIntosh 1984. A hypothetical relationship between differential algal sedimentation and diatom succession. *Verh. int. Verein. Limnol.* 22: 1361-1365.
- SNSF 1976. Impact of Acid Precipitation on Forest and Fresh water Ecosystems in Norway. SNSF-project, Oslo-Ås FR6. 111 p.
- SNSF 1977. Sur nedbør og noen alternative kilder som årsak til forsurening av vassdrag. SNSF-prosjekt, Oslo-Ås. Comments to Rosenqvist 1977. 168 p. + appendix.
- Stenson, J. A. E. 1985. Biotic structures and relations in the acidified Lake Gårdsjøen system-A synthesis. *Ecol. Bull. (Stockholm)* 37:319-326.
- Strickland, J.D.H. & T. R. Parsons 1968. A practical handbook of seawater analysis. *Bull. Fish. Res. Bd Can.* 167: 1-311.
- Stockner, J.G. 1972. Paleolimnology as a means of assessing eutrophication. *Verh. int. Verein. Limnol.* 18: 1018-1030.
- Strøm, K. M. 1931. Feforvatn. A physiographical and biological study of a mountain lake. *Arch. Hydrobiol.* 22: 491-536.

Stuanes, A.O. 1980. Sur nedbør - sur jord - surt vann. *Vann* 15: 344-348.

Stumm, W. & J.J. Morgan 1970. *Aquatic Chemistry. An Introduction Emphasizing Chemical Equilibria in Natural Waters*. Wiley - Interscience, New York. 583 p.

Sugawara, K. 1951. National report on hydrology, Japan. International Association of Hydrology. Brussel Assembly, August 1951. 21 p.

Sørensen, N.A. 1980. The influence of vegetation on pH in soils and water. Foredrag ved Universitetet i Trondheim, NTH, juni 1980. 37 p.

Sørensen, N.A. 1981a. SNSF-prosjektet: Erfaringer omkring vannkjemi. Kommentar til Richard F. Wright. *Vann* 16: 201-205.

Sørensen, N.A. 1981b. Er Sørlandet et unntak fra vanlig ferskvannskjemi? *Vann* 16: 18-322.

Sørensen, N.A. 1982. 1. Klarålvens kjemi - finnes det en gradient over tid. 2. De ombrogene myrers svovelinnhold; Sulfatnedfallet i preindustriell tid. Foredrag på seminar om «Sur nedbør» arrangert av NIVA og SI 6.-7. desember 1982. Manuscript.

Tessenow, U. 1966. Untersuchungen über den Kieselsäurehaushalt der Binnengewässer. *Arch. Hydrobiol. Suppl.* 32: 1-136.

Tessenow, U. 1975. Lösungs-, Diffusions- und Sorptionsprozesse in der Oberschicht von Seesedimenten. *Arch. Hydrobiol. Suppl.* 47: 325-412.

Thomas, E.A. 1955. Sedimentation in oligotrophen und eutrophen Seen als Ausdruck der Produktivität. *Verh. int. Verein. Limnol.* 12: 383-393.

Thunmark, S. 1937. Über die regionale Limnologie von Südschweden. *Årsb. Sver. geol. Unders.* 31: 1-160.

Tirén, T. 1981 Den interna svavel- och kräveomsättningens betydelse för forsurening av limniska ekosystem. Statens Naturvårdsverk PM 1376. 68 p.

Ulrich, B. 1980. Production and consumption of hydrogen ions in the ecosphere. In: Hutchinson, T.C. & M. Havas (eds.): *Effects of acid precipitation on terrestrial ecosystems*. Plenum Press: 255-282.

Uhlen, G. 1979. Virkning av planterester på smeltevannets kjemiske sammensetning. *Vann* 14: 140-143.

Vallentyne, J.R. 1955. Sedimentary chlorophyll determination as a paleobotanical method. *Can. J. Bot.* 33: 304-313.

Vangenechten, J.H.D., S. Van Puymbroeck & O.L.J. Vanderborgh 1979. Effect of pH on the uptake of sodium in the Waterbugs *Corixa dentipes* (Thoms.) and *Corixa punctata* (Illig) (Hemiptera, Heteroptera). *Comp. Biochem. Physiol.* 64A: 509-521.

Vik, E.A. 1982. Treatment of Potable Water Containing Humus by Electrolytic Addition of Aluminium. Ph. D. dissertation, Dept. of Civil Eng. Univ. of Washington, Seattle, June. 297 p.

Vollenweider, R.A. 1976. Advances in defining critical loading levels for phosphorus in lake eutrophication. *Mem. Ist. Ital. Idrobiol.* 33: 53-83.

Werescagin, U. 1931. Methoden der hydrochemischen Analyse in der limnologischen Praxis. *Verh. int. Verein. theor. angew. Limnol. Arb. d. Standardisationskomm.* 1: 1-230.

Wetzel, R.G. 1970. Recent and postglacial production rates of a marl lake. *Limnol. Oceanogr.* 15: 491-503.

Wetzel, R. G. 1975. *Limnology*. W.B. Saunders Company. Philadelphia, London, Toronto. 743 p.

Williams, J.D.H. & T. Mayer 1972. Effects of sediment diagenesis and regeneration of phosphorus with special reference to lakes Erie and Ontario. In: Allern, H.E. & J.R. Kramer (eds.): *Nutrients in natural waters*. John Wiley and Sons, Inc., New York: 281-315.



- Wright, R.F. & E.T. Gjessing 1976. Acid precipitation: Changes in the chemical composition of lakes. *Ambio* 5: 219-223.
- Wright, R.F. & A. Henriksen 1980. Hydrologic and chemical studies at Langtjern. SNSF-project, IR 71/80. 108 p.
- Wright, R.F., T. Dale, A. Henriksen, G.R. Hendry, E.T. Gjessing, M. Johannessen, C. Lysholm & E. Støren 1977. Regional surveys of small Norwegian lakes October 1974, March 1975, March 1976 and March 1977. SNSF-project, IR 33/77. 153 p.
- Yoshimura, S. 1932. On the dichotomous stratification of hydrogen ion concentration of some Japanese lake waters. *Jap. J. Geol. Geogr.* 9: 155-185.
- Ødelien, M., I. Haddeland, A. Njølstad & A.R. Semler-Olsen 1973. Eksempler på svoveloksydasjon og reduksjon av svovelforbindelser i jord og vann. *Ny Jord* 60: 31-40.
- Ødelien, M., A.R. Selmer-Olsen & I. Haddeland 1975. Investigation of some Red-ox Processes in Peat and their Influence on Run-off Water. *Acta Agric. Scand.* 25: 161-166.
- Ødelien, M., A.R. Selmer-Olsen & I. Haddeland 1976. Noen årsaker til pH-variasjoner i avrenningsvann fra udyrket sur jord (Variations in pH of run-off water from uncultivated acid soil). *Meddr norske myrselsk.* 74: 1-21.
- Økland, J. 1983. Miljø og prosesser i innsjø og elv. Ferskvannets verden 1. Universitetsforlaget, Oslo-Bergen-Stavanger-Tromsø. 203 p.
- Østrem, G. 1964. A method of measuring water discharge in turbulent streams. *Meddelelse nr. 8, Hydrologisk avdeling NVE*: 21-43.
- Åberg, B. & W. Rodhe 1942. Über die Milieufaktoren in einigen südschwedischen Seen. *Symb. Bot. Upsaliens.* 5: 1-256.

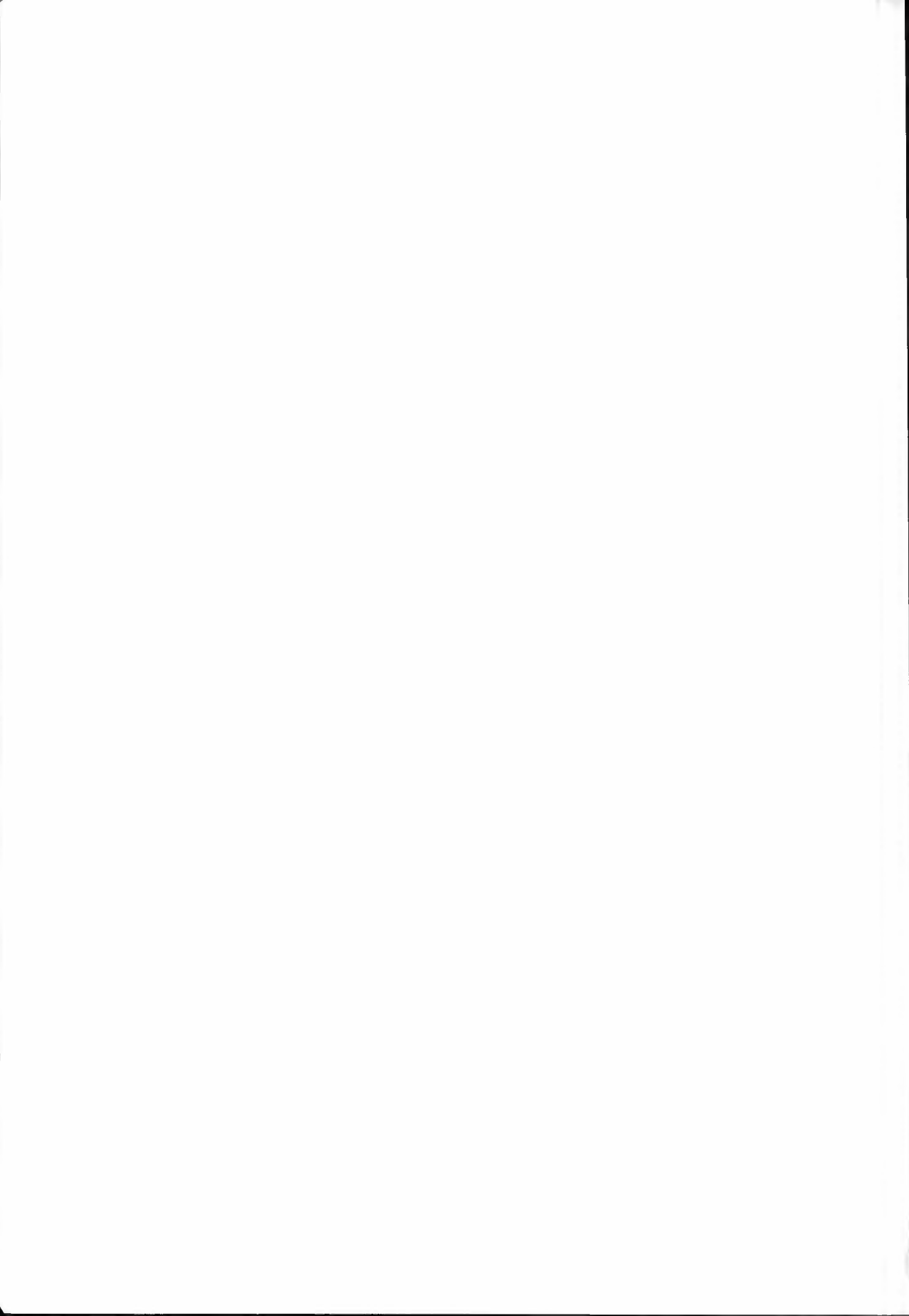

# NORWEGIAN JOURNAL OF AGRICULTURAL SCIENCES

## INSTRUCTIONS TO AUTHORS

### THE MANUSCRIPT

The manuscript shall be typewritten on one side of the paper only. It shall be double spaced and have margins of at least three centimetres. Each of the following elements of the manuscript shall begin on a new page: (1) the title, (2) abstract, (3) the text, (4) summary, (5) list of references, (6) tables, (7) figure legends.

The pages shall be numbered consecutively beginning with the title page.

Articles will usually be organized as follows: (1) introduction, (2) materials and methods, (3) results, (4) discussion and (5) summary. Up to three grades of headings can be used to divide up the text. Articles must not exceed 20 manuscript pages, and two copies should be submitted to the managing editor.

### TITLE PAGE

The title page shall contain:

1. A precise but brief title. A subtitle may be used, but also this should be brief.
2. A short title of not more than 40 letters and spaces for use as a running headline.
3. The full names of all authors.
4. The name and address of the institution and/or departments in which the research was carried out. Names of institutions shall be in English.

### ABSTRACT AND KEYWORDS

Use only keywords listed in Agrovoc. The abstract must not exceed 150 words, corresponding to 10 lines in print. The abstract shall briefly describe the purpose/question of the experiment/research project, the method, results and the principal conclusions drawn. Use only standard abbreviations in the abstract.

Do not use more than 10 keywords and list them alphabetically.

Indicate the name and address of the author to whom correspondence, proofs and offprints should be sent.

### ACKNOWLEDGEMENTS

Acknowledgement shall be made only to persons who have contributed substantially to the results of the research. Authors are responsible for ensuring that individuals named are recognized as being identified with the results and conclusions described in the article.

### TABLES

Each table shall be typed double spaced on a separate sheet of paper. They shall be numbered consecutively with Arabic numerals and have a concise descriptive heading. Abbreviations in tables shall be explained in footnotes, using the following symbols in this order: <sup>1)</sup>, <sup>2)</sup>, <sup>3)</sup>, <sup>4)</sup>, <sup>5)</sup>.

Avoid horizontal and vertical rules (lines) in tables. Tables shall be self explanatory as far as possible without the reader having to refer to the text.

### FIGURES

All illustrations, line drawings as well as photographs, shall be considered as figures. Figures shall be numbered consecutively with Arabic numerals. Letters, numerals and symbols must stand out clearly and be in relation to each other. Make sure they are large enough to take reduction. Before preparing line drawings the author should decide whether they are to be of 1 column, 1½ columns, or 2 columns with so that lettering, etc., after reduction, will be the same size on all drawings. Photographs should be submitted as near to their printed size as possible. If enlargement or reduction is significant in an photograph, the scale should be given on the back and not in the legend. The legend should make the general meaning comprehensible without reference to the text. Figure legends, shall be typewritten together on one or more sheets of paper.

### REFERENCES

Reference indicators in the text will follow the Harvard style, with the author's name and the year of publication: Høeg (1971), or (Høeg 1971). The text reference indicator to a work by two authors is given by naming both authors: Oen & Vestrheim (1985) or (Oen & Vestrheim 1985). If three or more authors, the text reference indicator is given by adding et al. to the first named author: Aase et al. (1977) or (Aase et al. 1977).

In the list of references authors' names are listed alphabetically. Two or more works by the same author are listed chronologically and if published in the same year must be distinguished by the appendage a, b, etc. after the year of publication. The corresponding appendage must also appear in the text indicator.

Høeg, O.A. 1971. Vitenskapelig forfatterskap. 2. utg. Universitetsforlaget, Oslo. 131s.

Oen, H. & S. Vestrheim 1985. Detection of non-volatile acids in

sweet cherry fruits. *Acta agriculturae scandinavia* 35: 145-152.

Strømnes, R. 1983. Maskinell markberedning og manuell planting.

Landbrukets årbok 1984: 265-278.

Uhlen, G. 1968. Nitrogengjødsling til ettårig raigras. *Jord og avling* 10(3): 5-8.

Aase, K.F., F. Sundstøl & K. Myhr 1977. Forsøk med strandrøyr og nokre andre grasartar. *Forskning og forsøk i landbruket* 27: 575-604.

Notice that:

- Only the first named author's initials and surname are inverted.
- The ampersand symbol is used between author's names.
- The date after the author's name is the year of publication.
- The issue number is given in parentheses after the volume number and only in cases where each issue of a particular volume begins on p. 1.
- A colon is used before page numbers in journal articles.
- The year of publication suffices in cases where the volume number is missing.
- In references to a book, the name of the publisher and the place of publication are given after the title of the book. If more than one edition of a book has been published, the edition used must be indicated. The number of pages should be given.
- It is recommended not to abbreviate the titles of periodicals, but in cases where this has nevertheless been done, abbreviations should be in accordance with the World List of Scientific Periodicals and/or BUCOP British Union Catalogue of Periodicals.

### ABBREVIATIONS

Use standard abbreviations where available, otherwise abbreviations given in the text should be explained at their first mention. Quantities and units of measurement shall be in accordance with «Système International d'Unites» (SI).

### PROOFS

Page proofs will be sent to the author for proofreading. They should be read immediately and returned to the journal's editorial office. Printer's mistakes should be marked with a blue pen and any possible changes made by the author against the manuscript in red. The second proof will be checked at the editorial office.

### OFFPRINTS

An order form for offprints, plus price list, will be sent to authors along with the first proofs. The author(s) will receive 50 offprints free of charge. This form should be filled out and returned with the first proofs to the editorial office.

Norsk Institutt for Skogforskning

1432 ÅS-NLH