



Norges miljø- og  
biovitenskapelige  
universitet

**Master's Thesis 2019 30 ECTS**

Faculty of Chemistry, Biotechnology and Food Science (KBM), at the  
Norwegian University of Life Sciences

# **Quorum sensing in the opportunistic pathogen *Pseudomonas aeruginosa* regulates N<sub>2</sub>O reduction**

**Glenn Atle Stensland**

Molecular biology



**Quorum sensing in the opportunistic pathogen  
*Pseudomonas aeruginosa* regulates N<sub>2</sub>O reduction**

Master Thesis  
**Glenn Atle Stensland**

Institute of Chemistry, Biotechnology and Food Science  
**Norwegian University of Life Sciences**  
**Ås 2019**

**Master Thesis Supervisors:**

Main supervisor

Dr. Linda Liberg Bergaust

Researcher

Phone: +4767232449

E-mail: [linda.bergaust@nmbu.no](mailto:linda.bergaust@nmbu.no)

Co-supervisor

Ricarda Kellermann

PhD student

Phone: +4767232572

E-mail: [ricarda.kellermann@nmbu.no](mailto:ricarda.kellermann@nmbu.no)

## Table of Contents

Abstract.....	6
Sammendrag.....	7
Introduction .....	8
The Denitrification Process .....	9
<i>Pseudomonas aeruginosa</i> .....	12
Quorum Sensing.....	14
Materials and Methods.....	18
The Bacteria .....	18
Safety Measures.....	18
The Medium.....	19
Culturing Conditions .....	20
The Robot Incubation System .....	22
Securing a Pure Culture .....	25
Growing the Culture.....	25
DNA Extraction and PCR.....	26
Gel Electrophoresis .....	27
Test of new primers .....	28
Growth curves.....	28
Cell Count by UV Microscopy.....	30
Cell Count by Flow Cytometry.....	31
Experimental Protocol .....	33
Preparations.....	33
Gas Kinetics and Sampling .....	34
Nitrite Measurements.....	36
RNA Extraction, Turbo DNA-free Treatment and Reverse Transcription .....	37
Droplet Digital PCR.....	38
Western Blotting.....	41
Results and discussion .....	45
Securing a Pure Culture .....	45
Test of new primers .....	46
Growth curves.....	46
Main experiment.....	48
Conclusion.....	59
References .....	61
Addendum .....	66

## Abstract

Through a process called denitrification, bacteria can respire with the use of as terminal electron acceptors instead of oxygen. An intermediate of the denitrification process, nitrous oxide (N<sub>2</sub>O), often escapes to the atmosphere instead of being reduced to N<sub>2</sub>. With properties such as being a potent greenhouse gas and ozone destructor, N<sub>2</sub>O has gained a lot of interest. The biggest anthropogenic N<sub>2</sub>O emission comes from agriculture, especially with the use of N-fertilizers. With the rise of global food demand, agriculture is becoming more and more important, which is also true for the use of N-fertilizer. Understanding denitrification will lead to knowledge of how to reduce N<sub>2</sub>O emission. Enter *Pseudomonas aeruginosa*, a well-studied model organism with a full denitrification apparatus: the bacterium contains genes encoding all factors necessary for the complete reduction of nitrate. This bacterium is also the leading cause of high mortality rate infections in hospitals. Gas kinetics performed in this study implies that mutating *rhII* and *lasI* in *P. aeruginosa* severely reduces the accumulation of N<sub>2</sub>O during denitrification. Also, ddPCR performed in this study gives data on the transcriptional levels of nitrous oxide reductase (NosZ) during denitrification between a wildtype (PAO1) and the *-rhII -lasI* mutant to determine the level of regulation at a transcriptional level. The hypothesis is that disabling the RhII and LasI quorum sensing systems will remove the down regulation of *nosZ* transcription, which will lead to earlier and higher expression of *nosZ*. Furthering our understanding of how these quorum sensing systems impact N<sub>2</sub>O emissions can better equip us in a foreseeable future. A future of increased N<sub>2</sub>O emission following an increase in food demand and consequently agriculture and the usage of N-fertilizers across the world.

## Sammendrag

Gjennom en prosess kalt denitrifikasjon, kan bakterier respirere ved bruk av nitrogenoksider som terminal elektronakseptor istedenfor oksygen. Et mellom produkt av denitrifikasjonsprosessen, kalt dinitrogenoksid (N<sub>2</sub>O), slippes ofte ut i atmosfæren istedenfor å bli redusert til nitrogen gas (N<sub>2</sub>). Med egenskaper som å være en potent drivhusgass og ozon ødelegger, så har N<sub>2</sub>O fått mye interesse. Den største delen av menneskeskapt N<sub>2</sub>O utslipp kommer fra jordbruk, spesielt med bruk av nitrogen gjødsel. Med økende global matetterspørsel, vil jordbruk bli mere og mer viktig, samt bruk av nitrogen gjødsel. Å forstå denitrifikasjon vil lede til kunnskap om hvordan redusere N<sub>2</sub>O utslipp. Inn på scenen kommer *Pseudomonas aeruginosa*, en godt studert modell organisme med ett fullt denitrifikasjonsapparat: denne bakterien inneholder gener som koder for alle faktorer som er nødvendig for full reduksjon av nitrat til N<sub>2</sub>. I tillegg, er denne bakterien den ledende årsaken til sykehusinfeksjoner med høy dødsrate. Denne studien utforsket gasskinetikk som peker på at mutering av quorum sansing genene *rhII* og *lasI* i *P. aeruginosa* reduserer akkumulasjon av N<sub>2</sub>O fra denitrifikasjon. Droplet digital PCR ble også brukt i denne studien for å skaffe data om transkripsjonsnivået av dinitrogenoksid reductase (*NosZ*) hos en villtype (PAO1) og en *-rhII -lasI* mutant under pågående denitrifikasjon for å bestemme graden av regulering av transkripsjon. Hypotesen er at ved å deaktivere *RhII* og *LasI* quorum sansing systemene vil fjerne nedreguleringen av *nosZ* transkripsjon, noe som vil lede til en tidligere og høyere ekspresjon av *nosZ*. Videreutvikling av vår forståelse for hvordan disse quorum sansing systemene påvirker N<sub>2</sub>O utslipp kan utruste oss til å håndtere en overskuelig fremtid. En fremtid med økte N<sub>2</sub>O utslipp som følge av en økende, global matetterspørsel og med etterfølgende økninger i jordbruk og bruk av nitrogen gjødsel i hele verden.

## INTRODUCTION

Through a process called denitrification, bacteria can respire with the use of nitrogen oxides as terminal electron acceptors instead of oxygen. This process is adopted by a wide variety of microorganisms, but the last step is only performed by prokaryotes: converting nitrous oxide (N<sub>2</sub>O) into dinitrogen (N<sub>2</sub>). Denitrification is the leading source of N<sub>2</sub>O and also the only known N<sub>2</sub>O sink. However, N<sub>2</sub>O often manage to escape before the prokaryotes are able to reduce it to N<sub>2</sub>. By extension, N<sub>2</sub>O emission is the net balance between the production and reduction of N<sub>2</sub>O by denitrifiers. The consequences of N<sub>2</sub>O emission sparks interest in studying denitrification in prokaryotes. Firstly, N<sub>2</sub>O emission from denitrification causes a huge loss of nitrogen, which is the most limiting nutrient in crop production. Secondly, denitrification has environmental importance being the main source of N<sub>2</sub>O emission, with N<sub>2</sub>O being considered a greenhouse gas by the Kyoto protocol (Philippot et al., 2007).

N<sub>2</sub>O is water-soluble gas that have a history of being used as an anaesthetic by its colloquial name: laughing gas. At high temperatures, N<sub>2</sub>O is a powerful oxidizer and have been used as oxidant in fuels (Spiro, 2012). In 2001, N<sub>2</sub>O contributed 6 % of global warming (Rao & Riahi, 2006). N<sub>2</sub>O as a greenhouse gas is 300 times stronger than that of CO<sub>2</sub>, but is less prominent with a 300 ppb (0.00003%) compared to that of CO<sub>2</sub>: 430ppm (0.039%, 1300 times higher) (IPCC, 2014). Moreover, N<sub>2</sub>O is generally inert and capable of reaching the atmosphere, where it can reside for 114 years (Signor et al, 2013) and act as a potent greenhouse gas. Upon reaching the stratosphere it also depletes ozone (O<sub>3</sub>). Ravishankara et al. (2009) shows in their study that N<sub>2</sub>O is the single most important O<sub>3</sub>-depleting emission. Additionally, it is also the largest anthropogenic emission of a O<sub>3</sub>-depleting compound (Portmann et al., 2012). Atmospheric levels of N<sub>2</sub>O have increased from 270 ppb to 330 ppb from 1850 to 2014, respectively. From year 1970 to 2000 the annual increase of atmospheric N<sub>2</sub>O was 1.3%, but from 2000 to 2010 it had increased to 2.2 % (IPCC, 2014). Sources of N<sub>2</sub>O emission include agricultural soil, animal manure, sewage, industry, automobiles and biomass burning. However, the largest source was agricultural soil, contributing with over 70% of N<sub>2</sub>O emission. The nitrogen turnover through microbes in the soil is a source of N<sub>2</sub>O emission. However, modern agricultural practices, such as utilizing N-



fertilizers, has contributed severely to increased emission (Rao & Riahi, 2006). The human population is on the rise and causing increased world food production, thus the use of fertilizer increases as well, especially in developing countries (Conant et al., 2013). The worldwide N consumption as fertilizer was 111.3 Mt in 2013 and forecasted to 119.5 Mt in 2018, an increase of 7.4% (Heffer and Prud'homme, 2014). Of the huge N-input of 150Tg/yr from N-fertilizers, agricultural soils produced 17 Tg/y N<sub>2</sub>O (Herridge et al., 2008).

## The Denitrification Process

Denitrification is a respiratory process in which nitrogen oxides are used instead of oxygen as electron acceptors. In the denitrification process, nitrate (NO<sub>3</sub><sup>-</sup>) and nitrite (NO<sub>2</sub><sup>-</sup>) are reduced to dinitrogen (N<sub>2</sub>) through the intermediates nitric oxide (NO) and nitrous oxide (N<sub>2</sub>O). The process is regulated by exogenous factors, such as abundance of active nitrogen and oxygen. Most denitrifying bacteria will respire with oxygen when its readily available, but when the oxygen falls below a certain concentration with the presence of active nitrogen it will switch to denitrification. Nitrous oxide reductase (N<sub>2</sub>OR or NosZ) is the enzyme catalyzing the last step in denitrification: reducing N<sub>2</sub>O to N<sub>2</sub>. This enzymes function is heavily regulated by pH. At pH 6.2 the protein is not assembled correctly, and lose its ability to perform the reduction step (Liu et al., 2014). The function of this enzyme is important from an environmental standpoint. Therefore, it would be natural to understand how this enzyme works.

In studied proteobacteria, the shift to denitrification is generally regulated by FNR/CRP type transcriptional factors and/or two component systems. In FNR/CRP types, the process starts when low oxygen tension is detected by global oxygen-sensing regulator FNR and a nitrate sensor detects nitrate in the periplasm. The presence of nitrate activates transcription of denitrification enzymes. The protein NarK1, a nitrate/proton symporter, is among the first to be expressed and is responsible for importing nitrate into the cytoplasm. NarK2 gets expressed later and is a nitrate/nitrite antiporter, which imports nitrate into the cytoplasm

Quorum sensing in the opportunistic pathogen *Pseudomonas aeruginosa* regulates  $N_2O$  reduction and exports nitrite out into the periplasm. (Kraft et al., 2011). In the denitrification process, nitrate is reduced to dinitrogen in multiple steps as seen in Figure 1, below. The enzymatic reactions take place both in the periplasm and the cytoplasm of the bacteria, creating a proton motive force across the membrane used to produce ATP. Most of these enzymatic reactions can be catalyzed by multiple, different enzymes and an organism typically possess only one for each reaction. Firstly, acting as the nitrate reductase catalyzing the reduction of  $NO_3^-$  to  $NO_2^-$  there are three known, different enzymes: NarGHI, NapAB or NasCA (Moreno-Vivián et al., 1999). Then, for the nitrite reductase are two known enzymes: NirS and NirK (Yan et al., 2003). The nitric oxide reductase has two known enzymes: NorB and NorVW (Braker & Tiedje, 2003; Vázquez-Torres & Bäumlér, 2016). Lastly, the nitrous oxide reductase has only one known enzyme: NosZ (Viebrock & Zumft, 1988).

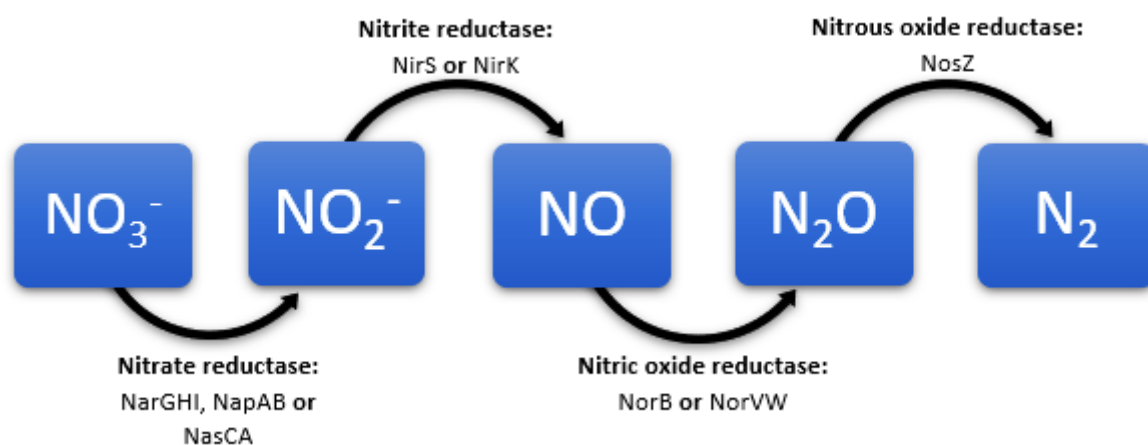

Figure 1: A simple figure over the denitrification process in studied proteobacteria and the enzymes involved. There are three known nitrate reductases, which reduces  $NO_3^-$  to  $NO_2^-$ : NarGHI, NapAB, NasA. There are two known nitrite reductases, which reduces  $NO_2^-$  to NO: NirS and NirK. There are two known nitric oxide reductases, which reduces NO to  $N_2O$ : NorB and NorVW. Lastly, there is only one nitrous oxide reductase, which reduces  $N_2O$  to  $N_2$ : NosZ. The figure is adapted after the denitrification group in FIG 1. from the paper of Alvarez et al. (2014).

*Pseudomonas aeruginosa* possess the denitrification enzymes NarGHI, NirS, NorB and NosZ. During denitrification, nitrate in the cytoplasm is reduced to nitrite by nitrate reductase NarGHI, a membrane bound enzyme complex. The active site of NarG, a molybdenum cofactor, resides on the subunit of the complex that faces the cytoplasm. NarI is the subunit that anchors to the membrane and when reducing nitrate, it will receive 2 electrons from the quinone pool in the membrane. These electrons are passed through two

*hemes b* unto subunit NarH that links NarI and NarG. NarH has four Fe-S clusters that passes the two electrons to a Fe-S cluster on NarG. From this cluster, the electrons are transported to the active site on NarG and it will then reduce the attached nitrate molecule to nitrite:  $\text{NO}_3^- + 2\text{H}^+ + 2\text{e}^- \rightarrow \text{NO}_2^- + \text{H}_2\text{O}$ . After this reduction step, the nitrite is transported into the periplasm by NarK2. As the negative charge is transferred to the cytoplasm, a complementary positive charge is created in the quinone pool in the membrane that donated the electrons. At the same time, protons are consumed in the cytoplasm, in the reaction mentioned above, and this is true for each reduction step. NirS is the enzyme catalyzing the next reduction step. This periplasmic enzyme consists of two cytochrome *cd*<sub>1</sub> monomers binding two prosthetic heme groups: heme *c* and heme *d*<sub>1</sub>. Cytochrome *c551* acts as an electron donor and transfers electrons through heme *c* to heme *d* where nitrite binds and the reduction takes place:  $\text{NO}_2 + 2\text{H}^+ + 2\text{e}^- \rightarrow \text{NO} + \text{H}_2\text{O}$ . The nitric oxide reductase in *P. Aeruginosa* is of the type short chain NOR (also written (sc)NOR) and is in a complex with NorC and NorB. Electrons are first transported from the quinone pool to cytochrome *bc*<sub>1</sub>, or from soluble cytochrome *c*, which transfers the electrons to the membrane bound cytochrome *c*: NorC. Then the electrons are transferred to NorB, the subunit with the active site, and nitric oxide is reduced to nitrous oxide:  $2\text{NO} + 2\text{H}^+ + 2\text{e}^- \rightarrow \text{N}_2\text{O} + \text{H}_2\text{O}$ . It is noteworthy that NO is a radical, which can cause irreversible damage to biomolecules like enzymes and membrane lipids (Feeney et al, 1976). Thus, bacteria usually want to prevent NO accumulation. Studies points to co-regulation of respiratory NIR and NOR, through CRP-FNR protein family regulators that responds to nitric oxide (Spiro, 2007). The last reduction step is performed by NosZ, a multicopper enzyme which exists in the periplasm with gram-negative bacteria. NosZ is a homodimer with four total copper centers: a Cu<sub>A</sub> and a Cu<sub>Z</sub> copper center per monomer. The copper atoms are ligated by seven histidine residues and a bridging sulfur atom, and it is the Cu<sub>Z</sub> copper center that acts as the enzymatic site (Brown et al., 2000). When N<sub>2</sub>O is reduced to N<sub>2</sub> electrons are transferred from Cu<sub>A</sub> of each monomer to the Cu<sub>Z</sub> of the other monomer. (Tavares et al., 2006; Kraft et al., 2011)

Everything we know of denitrification is based on the study of a select few model organisms, most of them being gram negative. The gamma proteobacterium *Pseudomonas aeruginosa* is one of these well-studied model organisms, which is also an important

Quorum sensing in the opportunistic pathogen *Pseudomonas aeruginosa* regulates N<sub>2</sub>O reduction pathogen. Furthermore, *P. aeruginosa* possess a full denitrification apparatus: the bacterium carries genes encoding all the factors necessary for the complete reduction of nitrate into N<sub>2</sub>.

## ***Pseudomonas aeruginosa***

*P. aeruginosa* is an opportunistic pathogen that can be found almost everywhere. This bacterium is Gram-negative, rod-shaped, encapsulated, motile and a facultative anaerobe (Alhazmi, 2015). Its most important anaerobic metabolisms include a complete denitrification apparatus and fermentation of arginine and pyruvate (Eschbach *et al.*, 2004). The bacterium's ability to exploit a wide variety of different nutritional sources, and its high potential for adaptation, allows for a wide range of habitats. Examples include (but are not limited to): water, wastewater, soil, and on the surfaces of humans, animals and plants (Green *et al.*, 1974; Klockgether *et al.*, 2011; Schwartz *et al.*, 2006). *P. aeruginosa* is one of the most relevant pathogens causing opportunistic infections in humans. In hospitals this bacterium often leads to severe nosocomial infections, for the most part in the critically ill or immunocompromised. *P. aeruginosa* is ubiquitous, and this is the cause for the frequency of *P. aeruginosa* infections in hospitals. A *P. aeruginosa* infection boast mortality rates above 30%, and possess limited susceptibility to antimicrobial agents and antibiotic resistance making treatment difficult (Juan *et al.*, 2017).

*P. aeruginosa* have an optimal growth rate at the temperature of 37 °C. However, it can survive at within the wide temperature range of 4 °C to 42 °C. The temperature affects virulence in pathogens, such as *P. aeruginosa*, and while below 30°C the virulence pathways are inactive. *P. aeruginosa* can be preserved in frozen stocks of 20% glycerol or 10% skim milk at -80 °C (LaBauve and Wargo, 2012). *P. aeruginosa* is a well-studied bacterial model organism (Toyofuku *et al.*, 2011), and the points of interest is its denitrification apparatus, huge regulation apparatus and the fact that it is a robust (includes multiresistant), opportunistic human pathogen. The strain used in this experiment, PAO1, is a clinical isolate turned into a laboratory strain, also a sub-line, and are commonly used to study the biology

Quorum sensing in the opportunistic pathogen *Pseudomonas aeruginosa* regulates N<sub>2</sub>O reduction and genetics of *P. aeruginosa*. It has been demonstrated that these sub-lines of PAO1 differ from the original strain significantly, as it has been adapted to a laboratory environment. These differences include mutations in quorum sensing, drug efflux and in the type 3 secretion system (LaBauve & Wargo, 2012). Furthering the latter point, *P. aeruginosa* is one of the top three causes of opportunistic human infections, owing to its “intrinsic resistance to antibiotics and disinfectants” (Stover *et al.*, 2000).

*P. aeruginosa* has a highly conserved core genome and low sequence diversity (Klockgether *et al.*, 2011). Its genome consists of a circular chromosome accompanied by plasmids, and the genome is about 5.5-7 Mbp with a G + C content around 65-67% (GenBank accession: refseq. No. NC\_002516.2, Valot *et al.*, 2015) (Klockgether *et al.*, 2011). *P. aeruginosa* is a proteobacterium, which is one of the largest divisions within prokaryotes. Proteobacteria is a phylum of Gram-negative bacteria that contain most of the known Gram-negative bacteria. Furthermore, this phylum contains a large number of known pathogens (Gupta, 2000). Proteobacteria are split into 5 subdivisions, which are only determined by differences and/or likeness in 16S and 23S rRNA sequence. These subdivisions are named  $\alpha$ ,  $\beta$ ,  $\gamma$ ,  $\delta$  and  $\epsilon$ , whereof *P. aeruginosa* belongs to the  $\gamma$ -subdivision. The branching order of these subdivisions was deduced by Gupta (2000), using signature sequences of different proteins. The deduction is that proteobacteria evolved from a common ancestor in the following order: *Chlamydia-Cytophaga* group  $\rightarrow$   $\epsilon$ ,  $\delta$  group  $\rightarrow$   $\alpha$   $\rightarrow$   $\beta$   $\rightarrow$   $\gamma$ .

Denitrification in *P. aeruginosa* is heavily regulated: it possesses two transcription regulators homologous to the CRP/FNR-family regulating the process: anaerobic regulation of arginine deiminase and nitrate reduction (ANR) and dissimilative nitrate respiration regulator (DNR). The ANR regulatory protein monitors oxygen concentration: an [4Fe-4S]<sup>2+</sup> cluster in ANR is destroyed in the presence of oxygen. Therefore, ANR can only be active in low oxygen environments. When ANR is active it increases the transcription of DNR and NarXL. The latter, NarXL, is a two-component regulatory system (Härtig *et al.*, 1999; Toyofuku *et al.*, 2012). NarX is a sensor kinase that detects nitrate and then activates NarL, which is a response regulator. NarL regulates the transcription of *narK1*, *nirQ* and *dnr*. DNR activates by binding to NO, and while active it induces the transcription of NAR, NIR, NOR and NOS (Toyofuku *et al.*, 2012). The *dnr* gene has been identified near the structural genes

*nirS*, *norCB* and in a gene connected to the activation of *nirQ* reductases (Arai et al., 1995). The study of Arai et al. (1995) found that the promoter activity for these genes in *P. aeruginosa* were severely reduced in both *dnr* and *anr* mutants, which emphasizes a vital connection between these transcription regulators to the performance of the denitrification apparatus. In addition, there is other systems regulating the denitrification process in *P. aeruginosa*: The *lasI* and *RhlI* quorum sensing systems.

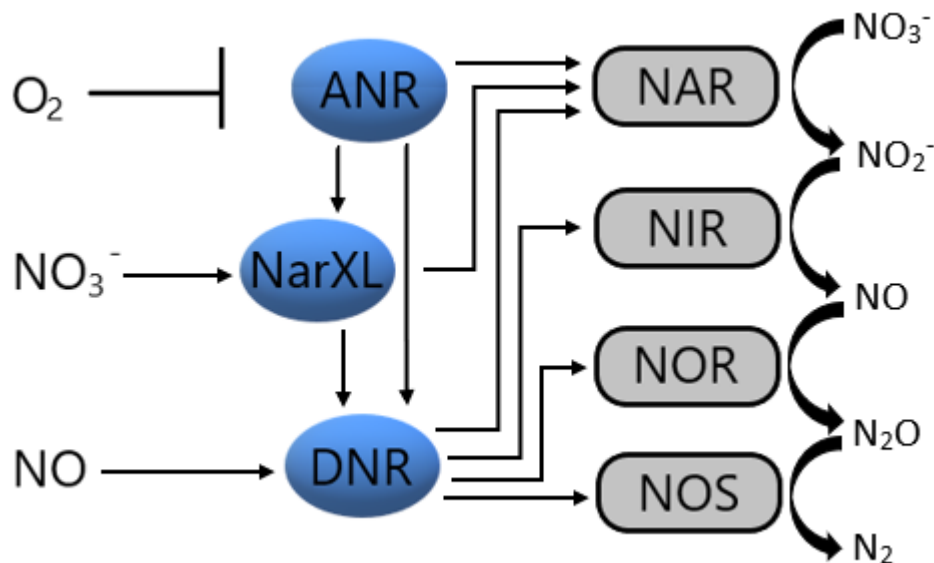

Figure 2: Regulation of denitrification by physiochemical factors in *P. aeruginosa*. ANR activates under low oxygen tension, which then increases the transcription of *NarXL* and *DNR*. The presence of nitrate activates *NarXL*, which increases the transcription of *DNR*. *DNR* activates by the presence of nitric oxide, which then increases the transcription of all denitrification enzymes: *Nar*, *Nir*, *Nor* and *Nos*. The figure is adapted after a figure 1 (b) in the paper by Toyofuku et al. (2012).

## Quorum Sensing

Quorum sensing (QS) allows collective alteration of behaviour in bacteria and is a cell-density dependant process (Turovskiy et al., 2007; Sperandio et al., 2001). A QS system produces extracellular signalling molecules, called autoinducers, which it releases and detects. As cell density increases, these molecules accumulate in the environment. Processes that are only effective at higher cell densities, such as production of biofilm,

bioluminescence and the secretion of virulence factors, are thus tightly connected to QS (Papenfort and Bassler, 2016). Based on its functions, QS is regarded as a form of cell-to-cell communication and its function is often compared to that of a language or behaviour (Turovskiy *et al.*, 2007; Taga *et al.*, 2001). In 1994, Fuqua *et al.*, (1994) coined this cell-density dependent system: “quorum sensing”.

QS was first described in Gram-negative *Vibrio fischeri*, a bacterium found living in symbiosis with marine fish and squids (Fuqua *et al.*, 1994). *V. fischeri* only expresses its characteristic trait, bioluminescence, in symbiosis. The Hawaiian bobtail squid (*Euprymna scolopes*) acquire the bacterium early on in life and keeps them in its light organ on the underside of its body. The squid uses the bioluminescent bacterium to provide counter illumination, reducing its silhouette, and at the onset of dawn it will release most of the bacterium (95%) and lose bioluminescence. Before dusk, the bacteria will reach high enough cell density in the light organ and become bioluminescent again (Jones and Nishiguchi, 2004). The reason for this behaviour is that bioluminescence (luciferase) is only expressed when the cell-density reaches about 10<sup>10</sup>-10<sup>11</sup> cells per ml (Fuqua *et al.*, 1994; Lupp *et al.*, 2003; Winans and Bassler, 2002).

There exists a lot of QS systems and accompanying autoinducers, and the QS systems are categorized by which autoinducer they are employing. Well documented autoinducers ranges from peptide signals (used by Gram-positive bacteria), acyl-homoserine lactones (AHLs, used by Gram-negative bacteria), autoinducer-2 (AI-2, used by both), diffusible signal factor (DSF), autoinducer 3 (AI-3), *Pseudomonas* quinolone signal (PQS, unique to *Pseudomonas*) and less documented 2-(2-hydroxyphenyl)-thiazole-4-carbaldehyde (IQS, produced by *P. aeruginosa*) (LaSarre and Federle, 2013; Papenfort and Bassler, 2016). The autoinducers of interest in this study are the AHLs, employed only by Gram-negative bacteria. They consist of a core *N*-acylated homoserine-lactone ring and a modified 4-18 carbon acyl chain, are synthesized from S-adenosylmethionine and have the important ability of being able to freely diffuse through the bacterial membrane. The AHLs are produced by LuxI-type synthases, and the length of the carbon acyl chain can affect stability and consequently signalling dynamics. (Papenfort and Bassler, 2016).

*P. aeruginosa* possesses four known QS systems: AHL QS systems LasI- (LasI/R) and RhII-RhIR (RhII/R); the PQS system; and lastly, the less known IQS system. The AHLs and PQS QS systems are well-known as they control important environmental factors and virulence factors (Pesci *et al.*, 1997; Toyofuku *et al.*, 2007; Toyofuku *et al.*, 2012). When considering control over environmental factors, the QS systems ability to repress denitrification activity are especially noteworthy. The LasI/R and RhII/R QS systems represses the transcription of the denitrifying reductases *nark1-narl*, *nirS-nirN*, *norC-norD* and *nosR-nosL*. Meanwhile, the PQS system activates the NIR enzyme while repressing the other mentioned denitrification enzymes (Toyofuku *et al.*, 2012). As for virulence factors, examples consist of motility, biofilm structure and dynamics, immune evasion, iron scavenging, cytotoxicity, and antibiotic resistance (Lee and Zhang, 2015). The LasR/I and RhII/R QS systems contain homologs of protein LuxI/R transcriptional regulators (Pesci *et al.*, 1997) described in the study by Fuqua *et al.* (1994). Data produced by Pesci *et al.* (1997) indicates that LasR and RhIR activates during the last half of log-phase growth and that the LasI/R QS system controls the RhII/R QS system, both transcriptional and posttranslational.

As previously mentioned, the signal molecules used in the LasI/R and RhII/R QS systems are AHLs. LasI synthesizes the AHL signal molecule N-(3-oxododecanoyl)-L-homoserine lactone (PAI-1), while RhII synthesizes the AHL signal molecule N-butyryl-L-homoserine lactone (PAI-2). When PAI-1 reaches critical concentration, it binds to LasR and will achieve autoinduction while activating a myriad of genes: *lasI*, *rhIR*, *lasB*, *lasA*, *apr*, and *toxA* (where the *lasI* gene is important for autoinduction). When the concentration of PAI-1 is bigger than PAI-2, it will block the RhIR-PAI-2 association. When RhIR and/or PAI-2 concentration is high enough it will overcome the blocking effect and bind to RhIR, achieving autoinduction and activating another myriad of genes: *rhII*, *rhIAB*, *lasB* and *rpoS* (where *rhII* is important for autoinduction). (Pesci *et al.*, 1997)

Gas kinetics performed in this study implies that mutating *rhII* and *lasI* in *P. aeruginosa* severely reduces the accumulation N<sub>2</sub>O during denitrification. PAO1 shows high accumulation of N<sub>2</sub>O starting at intermediate cell densities, while the *lasI-rhII* deficient mutant show little to no accumulation of N<sub>2</sub>O at any cell densities. Supporting this observation is the fact that a QS deficient mutant will have higher levels of denitrification activity during anoxia than that of the wildtype (Toyofuku *et al.*, 2007). However, ddPCR



Quorum sensing in the opportunistic pathogen *Pseudomonas aeruginosa* regulates N<sub>2</sub>O reduction

performed in this study gives data on the different transcriptional levels of the denitrifying reductases between a wildtype (PAO1) and the *-rhlI -lasI* mutant to determine the level of regulation at a transcriptional level. This data and the gas kinetics show a delayed reduction of N<sub>2</sub>O in the wildtype while showing near identical reduction rate for NO<sub>3</sub><sup>-</sup> and NO<sub>2</sub><sup>-</sup>.

Furthering our understanding of how these quorum sensing systems impact N<sub>2</sub>O emissions can better equip us in a foreseeable future. A future of increased N<sub>2</sub>O emission following an increase in food demand and consequently an increased usage of N-fertilizers across the world.

## MATERIALS AND METHODS

### The Bacteria

The bacteria used in the experiments were the *Pseudomonas aeruginosa* PAO1 wild type (PAO1-UW) and a double deletion mutant of this strain (PAO1 *rhII- lasI-*) (Wang et al., 2015). They are a courtesy from the laboratory of Professor Peter Greenberg (Department of microbiology, School of medicine, University of Washington: <http://depts.washington.edu/epglab>). The mutant is incapable of synthesizing AHLs, but has functioning AHL receptors and thus responds to AHL signals, if they are supplied. *P. aeruginosa* is a biosafety level 2 (BSL-2) pathogen and were handled following institutional guidelines for handling and safety (Burnett *et al.*, 2009). The strains were stored as 25% glycerol at -80 °C. When running experiments, 0,5-1mL (depending on how fast the culture was needed to grow) were extracted from 1mL vials, and marked as opened if opened once. They were never used more than twice, and often only once.

### Safety Measures

The bacteria were handled in its own lab with a self-closing, lockable door marked with a biohazard warning sign. The bacteria were never exposed outside of the lab. The lab had a sink with eyewash capabilities. Nitrile gloves were always used when handling bacteria, and disposed of before exiting the designated biohazard lab. Furthermore, wearing lab coat was mandatory in the lab, and eye protection if handling dangerous chemicals or the bacteria. Surfaces and equipment were cleaned with 70 % ethanol before and after handling of the bacteria. Infected materials were autoclaved prior to disposal or cleaning. Hand washing was performed if bacteria gets in direct contact with gloves, and/or before exiting lab if bacteria has been handled. Eating or drinking were not allowed in the lab, thus the presence of food or drinks in the lab was not allowed. If bacteria were spilled, it was decontaminated immediately by 70 % ethanol.

## The Medium

The medium used in the experiment was a modified version of Siström's medium (Siström, 1962). This medium was designed for the growth of *Rhodospseudomonas* and agrobacterium. The medium was prepared as a 10x stock, for the purpose of freezer storage and ease of access. The making of 1L Siström's medium 10x stock was done after the recipe below (Table 1), and sterile milliQ water was added to make it 1L. The total volume of 1L medium was split into 10 bottles of 100mL, for easier and faster thawing of desired volumes. The 10x stock was kept in a freezer at -20 °C. When making 1x Siström's medium from this stock, the pH must be brought to 7pH with the use of KOH after dilution. In this experiment, the Siström's medium was also mixed with agar to make Siström's agar plates to grow colonies on. This agar consisted of approximately 13-15% agar powder; the rest was Siström's medium.

*Table 1: Siström's medium composition (withstanding sterile milliQ). A) The Siström's medium; B) Trace elements solution; C) Vitamins solution. (Siström, 1962)*

A) Siström's medium		
Component	Amount (g or mL)	C in 10X medium
KH <sub>2</sub> PO <sub>4</sub>	27,2g	200mM
NH <sub>4</sub> Cl	1,95g	36,4mM
Succinic acid	40g	340mM
L-glutamic acid	1,0g	6,7mM
L-aspartic acid	0,4g	2,5mM
NaCl	5,0g	85mM
Nitritotriacetic acid	2,0g	
MgSO <sub>4</sub> *7H <sub>2</sub> O	3,0g	12mM
CaCl*2H <sub>2</sub> O	0,334g	2,3mM
FeSO <sub>2</sub> *7H <sub>2</sub> O	0,020g	0,07mM
Trace elements solution	1mL	
Vitamins solution	1mL	
(NH <sub>4</sub> ) <sub>6</sub> Mo <sub>7</sub> O <sub>24</sub> (1% solution)	0,2mL	

B) Trace elements solution (1000X for 10X medium)			Notes: Store at 4 °C. Add H <sub>2</sub> SO <sub>4</sub> by drops until solution clears. *) CoCl <sub>2</sub> *6H <sub>2</sub> O has replaced Co(NO <sub>3</sub> ) <sub>2</sub> *6H <sub>2</sub> O, for a NO <sub>3</sub> free medium.
Component	Amount (g/100mL)	Concentration	
EDTA	1,765	0,05 M	
ZnSO <sub>4</sub> *7H <sub>2</sub> O	10,95	0,038 M	
FeSO <sub>4</sub> *7H <sub>2</sub> O	5	0,018 M	
MnSO <sub>4</sub> *H <sub>2</sub> O	1,54	0,01 M	
CuSO <sub>4</sub> *5H <sub>2</sub> O	0,392	1,50 mM	
CoCl <sub>2</sub> *6H <sub>2</sub> O (*)	0,248	0,90 mM	
H <sub>3</sub> BO <sub>3</sub>	0,114	1,8 mM	

C) Vitamins solution (1000x) (100mL)		Note: Store at 4 °C
Component	Amount (g/100mL)	
Nicotinic acid	1,0	
Thiamine HCl	0,5	
Biotin	0,010	

## Culturing Conditions

The cultures were grown in sealed vials, sealed differently depending on desired oxitic condition. These vials contained slightly altered Siström's medium to make it absent of nitrogen oxides (NO<sub>x</sub>). A stirring magnet was also present in the vial and the vials were sealed with aluminium foil. The vials were sterilized by autoclave. Vials made for aerobic cultures were grown in vials supplied with an additional cotton seal placed in the neck of the vial, which was added before the vials were autoclaved. Anaerobic cultures were grown in vials sealed with a butyl rubber septa and aluminium cap replacing the aluminium foil seal, done after the vials were autoclaved. The septa were applied in a laminar air flow cabinet by using a sterile technique: tweezers were soaked in 70% ethanol which was then ignited by a Bunsen burner flame. After the septa were applied, an aluminium cap got crimped onto the

vials to firmly hold the septa in place and making the vials airtight. Furthermore, the anaerobic vials were made with KNO<sub>3</sub> concentration of 2mM, which *P. aeruginosa* can use as terminal electron acceptor in denitrification instead of relying on oxygen.

The vials were inoculated with bacteria directly from glycerol stock, in volumes of 0,5-1 mL depending on how fast you need the culture to grow. When the cultures were in the exponential phase, absorbance = 0.100, they were used to inoculate the vials that were used in the experiments. While growing cultures, the vials were placed in water baths with temperature control and magnetic stirring. The temperature selection ranged from 20 to 30 °C for *P. aeruginosa*, depending on wanted growth rate (higher temperature equals higher growth rate in this setting). During the experiment the temperature was set to 20 °C. The water baths are supplied with a magnetic stirring board and the vials were stirred vigorously at 500-750 rpm. The magnetic stirring hindered cell aggregation and provided a vortex, which created an exchange of gases between the liquid and the headspace of the vial. This gas exchange and hindered cell aggregation secured a consistent growth rate.

The anaerobic vials underwent helium washing, a technique where a pump is repeatedly used to evacuate the airspace of the vials and then replace it with helium. The helium washing system consists metal pipes and valves connected to different kinds of gas, wherein a gas can be selected by opening the respective valve, with the endpoint being a vacuum pump. On the pipe there are 15 valves connected to rubber tubes, all leading to a filter with an attached syringe needle. When preparing for helium washing, the vials were placed on a 15-slot magnetic stirrer board and the syringe needles were pierced through the septa of the vials and the valves were opened. The system was controlled by a program on a computer which lets you input cycles, evacuation time, helium time and end time. The inputs, in respective order, for our experiment was: 7, 180, 30, 10. Some vials was also evacuated of air: the program can be told to only apply vacuum and then after 0,01 mBar wa reached, the valve to the vial was closed. This was done when creating standards or pure gas filled vials: evacuated the bottles, then filled them with gas from gas canisters. Before starting the helium washing routine on the program, the helium valve was opened. The headspace of the anaerobic vials was evacuated and replaced with helium while placed on rigorous, magnetic stirring to ensure gas exchange between liquid and headspace during the routine. When the helium washing finished, all of the valves leading to the vials are first

closed and then the syringe needles are removed from the vials. If they are not closed before removing the needles, air can contaminate the entire system (including connected vials) and the helium washing needs to be redone. After running vials with liquid in them, the system must stay on for half an hour to evacuate the water that evaporated from the vials. This prevents damage to the system. Then the helium valve was shut and the pump was turned off. After a helium wash, whatever remains of N-gases in the liquid will diffuse into the headspace. Therefore, the helium washed vials are, preferably, prepared the day before use to allow diffusion until an equilibrium was reached (takes about 6 hours). This way, any N-gas trapped in the liquid will not diffuse during the experiment and affect the reading values of the headspace. Furthermore, an overpressure is created in the helium washed vials and before any gas sampling is done this overpressure needs to be alleviated. This was done by taking a syringe with a needle, removing the piston, filling it with 70 % ethanol and pierce the septum of the vial. Extraneous He-gas will be pushed out by the pressure and into syringe. The ethanol prevents diffusion between gas in the vial and the air, as the helium travels through the ethanol as bubbles. This was usually done when the vials have the temperature that was going to be run in the following experiment.

## **The Robot Incubation System**

The robot incubation system was made to measure gas kinetics of growing cultures over time. It is an in-house designed incubation system that automates gas sampling of vial headspace. The whole system persists of a temperature regulated water bath, one or two magnetic stirring board inside the water bath (each board provides stirring for 15 vials), a robot arm, a gas chromatograph (GC), an NO-analyser, and finally a computer with a program to run the system (figure 3). A python program controls the robot arm and sampling intervals. When it is time to sample, the robot arm will move above the target vial, pierce the septum and extract a specific amount of gas from the headspace. This gas sample is fed to the GC and the NO-analyser. 15 or 30 vials (+ standards) can be run in an experiment at a time, based on which robot incubation system is used. The liquid culture

vials used in these experiments are sealed with rubber septa with a crimped aluminium ring and are helium washed. Overpressure after helium washing is alleviated after the temperature of the vials have become that of the water in the water bath. A plunger less syringe filled with ethanol is used for this purpose (explained under culturing conditions). The vials are usually inoculated at experiment start. The data produced from the GC and NO-analyser is fetched by the same program controlling the robot arm. The sampling is performed by the robotic arm, which is carrying a needle connected to the GC (Agilent 7890B) and a NO-analyser (Sievers NOA-280i). NO<sub>2</sub><sup>-</sup> needs to be measured separately. This can be done by extracting liquid from the liquid culture in the vial during the experiment. The result is high resolution data of denitrification involved substrates/products: O<sub>2</sub>, CO<sub>2</sub>, NO<sub>2</sub><sup>-</sup>, NO, N<sub>2</sub>O, and N<sub>2</sub>.

In addition to vials with liquid culture, the robot incubation experiments are also supplied with three standards. The three standards are a High standard (151ppm N<sub>2</sub>O, 1,03 % CO<sub>2</sub> and 0,997 % CH<sub>4</sub>), a Low standard (normal air: 21 % O<sub>2</sub> and 78 % N<sub>2</sub>) and a NO-standard (25 ppm NO). These standards are used to collect data on gas leakage that happens during the experiments, which is used to correct for said leakage in the vials with liquid culture. The gas kinetics, data from the GC and NO-analyser over time, are monitored by the software Roboplot. The data allows one to pinpoint the transition from aerobic respiration to denitrification, and the start and end of every denitrification step. It can however not measure NO<sub>2</sub><sup>-</sup>. This is done on an external setup with another NO-analyser.

The robot system is not capable of analysing NO<sub>2</sub><sup>-</sup> and therefore an external chemical setup hooked to a NO-analyser was needed. This chemical setup resides within an airflow cabinet and starts with an inert gas supply with a valve, and ends with the NO-analyser (figure 4). The inert gas is carried by the gas pressure, through an inlet stopcock, through a needle valve into a reducing agent reservoir with water cooling. The inert gas travels through the reducing agent, carrying any gas with it through an outlet stopcock, passes through a filter with a cap and finally ends up in the NO-analyser. The reservoir has a drain stopcock, but more importantly an injection port with a septum where liquid sample can be injected with a syringe. The injection is done quickly and straight into the reducing agent. Any NO<sub>2</sub><sup>-</sup> in the liquid sample is reduced to NO, where a 1:1 reduction ratio is assumed, and the NO gas is carried by the inert carry gas into the NO-analyser. Before you can run

samples, the NO-analyser needs to be initiated and a test needs to be run. When the test is passed, the filter cap on the chemical setup is removed and the cell pressure is noted. Then, all the stopcocks in the chemical setup must be opened and the gas valve must be opened. At this point, gas bubbles should be perceived in the reducing agent. The cap is put back on, and the cell pressure is checked again. If it is not the same as the earlier noted value, the needle valve must be adjusted until the pressure is the same. On a computer hooked up to the NO-analyser, is a program recording the data. A switch is also present in the cabinet with the chemical setup, connected to the computer. When the program is running, inject 10  $\mu\text{L}$  sample into the reducing agent, and click the switch to start recording data to a real time graph. Upon detecting the NO peak, it will calculate a value which cannot be exported so it must be written down instead. The value can only be made sense of with the use of standards. In other words, a standard curve is made so the values can be converted into actual NO concentration (and by proxy,  $\text{NO}_2^-$  concentration).

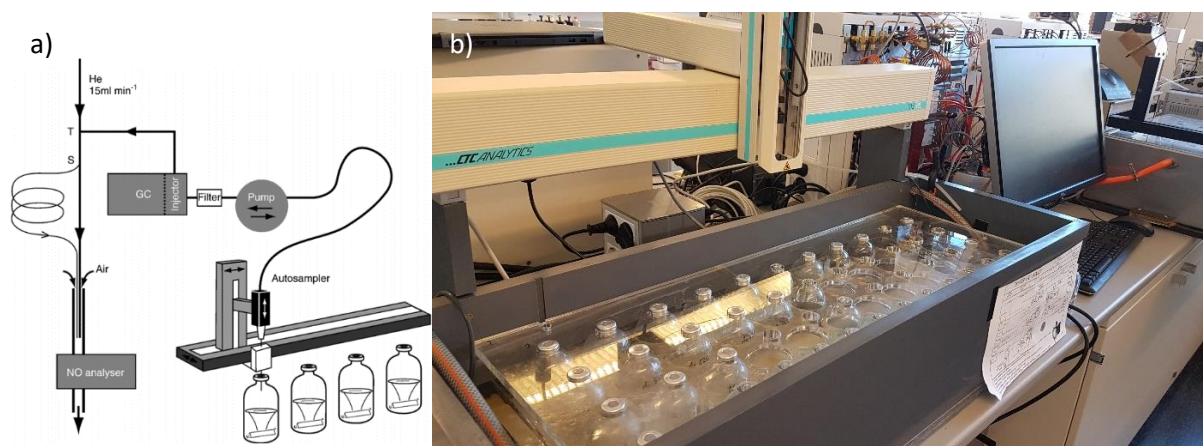

Figure 3: Picture of a robot incubation system. a) is a simplified figure of the robot incubation system. b) is a picture of the robot incubation system, with a 30-vial water bath. The NO-analyser is the machine behind and to the left of the robot arm, and the GC is the one to the right. The figure (a) is borrowed from Molstad et al. (2007). The system is explained in the text.



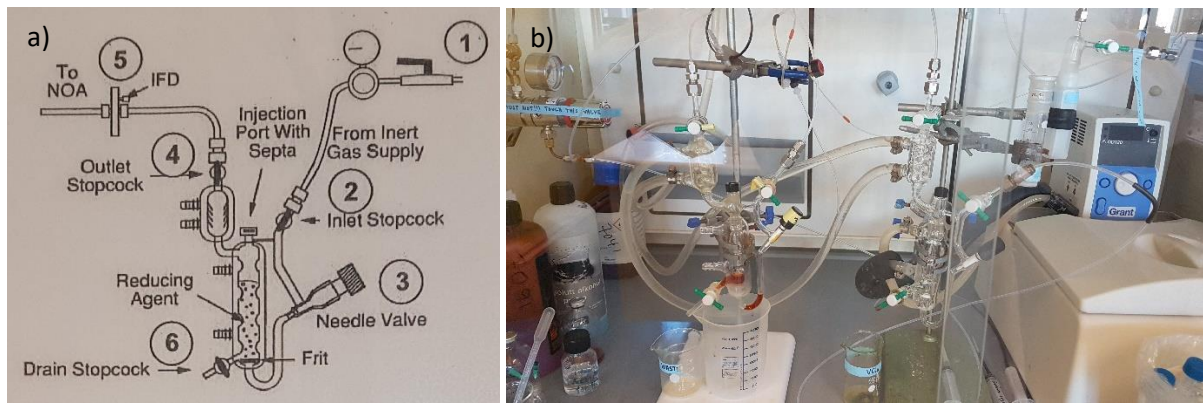

Figure 4: External, chemical NO<sub>2</sub><sup>-</sup> analyser setup. a) shows a drawing/figure of the actual setup, which is the left part of the chemical setup in the picture (b). b) shows the chemical setup. The NO-analyser and computer is outside on a desk and not in the picture. Read text to understand how it works.

## Securing a Pure Culture

### Growing the Culture

The frozen, at -80°C, glycerol stocks of PAO1 and PAO1 -rhII -lasI mutant were streaked onto respective Siström's agar plates (15% agar powder) by using the 16-streak method with an inoculation loop. This streaking method consists of making 4 parallel streaks, then the next 4 starting and crossing the end of previous streaks. Repeated until 4 sets of 4 streaks is had, totalling 16 streaks. When done this way, single colonies are consistently produced at the last set of streaks. The streaking took place in an air flow cabinet for sterility purposes, and were sealed with parafilm so the plates do not dry out while incubated for 3 days at 30 °C (3 days due to waiting out a weekend, 1 day will suffice). Furthermore, the plates were placed upside down, which prevents the humidity to collect at the agar surface where the bacteria are growing. After incubation, single colonies picked from the agar plates got streaked onto new, respective agar plates by same method and incubated overnight: same procedure as last time. Two bottles with liquid Siström's medium were inoculated with cells scraped from the new agar plates, one with PAO1 strain and one with the mutant strain. The inoculations were placed in a water bath at 30 °C with rigorous magnetic stirring. 15% glycerol stock of each strain was secured from the liquid culture.

## DNA Extraction and PCR

Extracted DNA from 1mL liquid culture of each strain using QIAamp DNA mini Kit (QIAamp DNA Mini and Blood Mini handbook, 2016, p. 33-35, 55-56). The result of the extraction was two volumes, one for each strain, of 50 µL with concentrations of 131 µg/mL for PAO1 and 132 µg/mL for the mutant strain, measured by Qubit dsDNA BR assay (Quick reference. Qubit assays. Pub. No. MAN0010876. Rev. A.0.). The samples were stored in a -20 °C freezer, after extracting enough to perform polymerase chain reaction (PCR). A PCR mix was made using TaKaRa ExTaq PCR mix (Table 2). The PCR reactions was setup in PCR tubes (Table 2: B & C) using *lasI* and *rhII* primer pairs with DNA of the wildtype and mutant as the templates, with an NTC for each primer pair (Template was replaced with sterile water for the NTCs) (Primer sequences can be found in Addendum table A1). The tubes were put in a thermal cycler following the program in Table 3. Upon successful PCR, certain fragment lengths were expected based on primer pair and strain type (*rhII/lasI* & WT/MUT). Firstly, the *rhII* primer pair should give fragments of length 850bp for the wildtype and around 400bp for the mutant. Secondly, the *lasI* primer pair should give fragments of length 999bp for the wildtype and around 500bp for the mutant. The product was ready for gel electrophoresis.

Table 2: Table over components for the PCR mix, reaction volume and the setup of tubes. A). Takara PCR mix components. B). Contents of reaction volume. C) Reaction setup

A) TaKaRa PCR mix components		
Component	µL in 25 µL reaction	8 reactions (µL)
TaKaRa Extaq(5 units per µL)	0,125	1
10x Extaq buffer	2,5	20
dNTP mix (2,5 mM each)	2	16
H <sub>2</sub> O (nuclease free)	16,375	131
Sum PCR mix:	21	168

B) Contents of Reaction volume	μL
PCR mix (from part A)	21
Primer 1 (Forward)	1
Primer 2 (Reverse)	1
Template (DNA, or sterile water [NTC])	2
Sum reaction volume:	25

C) Reaction setup (with tube numbers)			
Primer pair:	Template:		
	WT	MUT	NTC
<i>lasI</i>	1	2	3
<i>rhlI</i>	4	5	6

Table 3: Shows a thermal cycler program used in for TaKaRa ExTaq PCR mix. The thermal cycler program moves through each step, from top to bottom. The table shows the temperatures, how much time (seconds) they are held for each step. It also shows how many cycles that certain parts are repeated (blank means no cycles; it will be performed once). This program cycled step 2, 3 and 4 thirty times. When cycling, the steps are done in order of top to bottom for each cycle (2, then 3, then 4, repeat 30x).

Steps	Temperature	Time (s)	Cycles
1	94 °C	30	
2	98 °C	10	30 cycles
3	60 °C	30	
4	72 °C	60	
5	72 °C	300	
6	4 °C	∞	

## Gel Electrophoresis

Gel electrophoresis was performed to identify that the *lasI* and *rhlI* genes were present. 10 μL from each tube mixed with 2 μL loading dye (blue 6x concentration) were loaded onto a 1 % agarose gel. The gel was made by adding 0.6g agarose powder and 2 μL PeqGreen to 60ml TAE buffer in a gel cast with a well comb in place. The gel liquid took 20 minutes to

solidify. The mixing with loading dye was done with a pipette by applying the 10 µL of PCR product onto a 2 µL loading dye drop on the surface of a parafilm. The mix was aspirated and dispensed in place, until they had mixed properly. Then it was applied to a well on the gel, and this was done for each product on different places on the parafilm. In addition, two ladders were used to flank the samples. 5µL of Quick-Load Purple 100 bp DNA ladder (Addendum figure A1.A) were applied to a well on the left side of the products. On the right side was 10 µL of the same ladder (this was done to size out how strongly the ladder would appear on the gel image, for future reference). The gel was placed in an electrophoresis tub, which was then filled with TAE buffer up to the marked volume. The agarose gel was then run at 90V for 40min. When the run ended, an UV image visualizing the bands was created with the Molecular Imager® Gel Doc™ XR System from Bio-Rad (System can be viewed [here](#)).

## Test of new primers

New primers were bought in and was needed to be tested. These were primer pairs for the genes: *rpoS*, *narG*, *nirS*, *norB* and *nosZ* (sequences can be found in addendum table A2). gDNA from *P. aeruginosa* have already been produced earlier and stored in the fridge. PCR was performed after the procedure in **DNA extraction and PCR**, but with the new primer pairs. Then gel electrophoresis was done exactly the same as in **Gel electrophoresis**. There were no expected fragment lengths this time. This test was to ensure the primers worked; some were planned to be used in the main experiment.

## Growth curves

Optical density (OD) is a measure of the permeability of certain wavelength light through a medium/object. A spectrophotometer will give an absorption value based on how much of the light is absorbed: at A=0.000 all the light passes through, while at A=1.000 almost all the light is absorbed. To get more accurate values, samples should be diluted and measured

again if they reign in values close to 1. OD can be measured at different wavelengths ranging from 200nm to 0.3mm, which can give information related to the density of a specific wavelength absorbing object. The wavelength for measuring cell density is 600nm (OD<sub>600</sub>). By later counting cells, a cells/OD number can be calculated which can be used to estimate the number of cells in a vial culture. The cells/OD number is different from bacteria to bacteria, and from aerobic to anaerobic growth. When OD was measured, 1 mL of liquid was added to a cuvette, without coming in contact with the clear sides. The Shimadzu UV1280 spectrophotometer has a compartment with a lid to make compartment dark when measuring. In this compartment is the laser, the sensor and between is a slot for cuvettes. The wavelength of the laser was adjusted to 600nm and put on photometric mode, if not already. After placing a cuvette with pure Siström's medium (or MQ water, the absorption values are identical) and closing the lid, the instrument was calibrated by pressing the zeroing button. Then cuvettes with 1mL liquid culture were run, one at a time. The instrument shows an absorption value after pressing the enter button. These values are noted for each sample.

The dye used to stain cells for counting was SYBR-green, a green fluorescent cyanine dye. It is a popular dye for staining double-stranded DNA, but can stain single stranded and RNA at the cost of intensity. It is used primarily in real time PCR, but can be used to stain cells as well. SYBR-green absorbs blue light ( $\lambda$  max= 498 nm) and emits green light ( $\lambda$  max= 522 nm). Since it binds to DNA with a high affinity it is a possible carcinogen, and should be handled with care (SYBR-green also had a designated waste bin). SYBR-green was used for staining formalin fixated cells for counting by UV microscope and flow cytometer (on a 488 nm fluorescence band).

There were grown 8 cultures of PAO1, where 4 was aerobic and 4 was anaerobic. The anaerobic vials were made 4mM KNO<sub>3</sub> by injection. The aerobic cultures were grown and sampled over time at different optical densities measured by a spectrophotometer at 600nm (OD<sub>600</sub>). The OD was only measured from 1 vial of 4 for each treatment (aerobic/anaerobic), which was excluded from sampling. The concept being that the cultures in the vials grow at equal rate and the OD value of one vial reflect the OD values of the other vials for that treatment. At each sampling point, 2.7mL were extracted of the

liquid culture and fixated with 300 µL formalin in a dedicated formalin air flow cabinet. The samples were then stored in a fridge.

### Cell Count by UV Microscopy

Counting cells was done by using the BCZ square in a UV microscope (Leica DMRE microscope, type-F without auto-fluorescence) on an Anodisc filter. There is a lens with letter annotated lines, and the BCZ square is the area between the B and C line, with the right side of the square being the Z line. At a 100x objective, the BCZ square have a known area. In addition, with the known surface area of an Anodisc filter the counted cells can be converted to cells per filter and by proxy you can find out how many cells were in the applied sample. The sample volumes for the dilutions were based on wanted cells per square according to this formula:

$$X = \frac{N * 2.01 * 10^6}{10^9 * OD} mL \quad (\text{eq. 1})$$

Where *N* is wanted cells per BCZ square, and *OD* is the OD value of the bacterial sample (you solve for *X*) (Lindtveit, 2016).

After the volumes for making the correct dilutions were calculated, the samples were prepared for UV microscopy. Firstly, the samples were dispartaged with a syringe to lessen the effect of cell aggregation. The calculated volume was applied to 5mL Milli-Q water (MQ water) in a 15mL falcon tube. The samples were then applied to Anodisc filters (Whatman® Anodisc inorganic filter membrane) with a vacuum filter machine, fixating the cells to the surface of the filter. The machine consisted of a vacuum pump, connected to a vacuum chamber that had eight drains with a valve each. Any liquid that passes through the drains gets collected in the vacuum chamber. A GF/F filter was put in the top of a drain, then the Anodisc filter was put over the first filter and finally on top was placed a hollow metal cylinder made for holding the solution to be filtered through. Liquid is filtered by adding liquid to the hollow cylinder, opening the drain's valve and then start the vacuum pump. The pump is turned off when the filter appears dry again. First, 2mL MQ water was filtered through the filters on the vacuum filtering machine. Then the 5mL cell solutions were

filtered through. Then the filters were placed in a petri dish each, and then the cells on the filters were stained with a 100 µL drop of SYBR-green. After application of SYBR-green, the filters were left 20 minutes in darkness: wrapped in aluminium foil and placed in a drawer. After this, the excess SYBR-green was removed by putting the filters on an absorbent paper in a new petri dish, where the filter was held down flat with a glass slide pressing on an outer plastic ring that the Anodisc filters have. These were left in an incubator at 40 °C, wrapped by aluminium foil to keep them in the dark.

The UV microscopy was done with a BCZ square lens at 100x objective and cells within the BCZ square were counted. The Anodisc filter was put on a glass slide, and a drop of mounting solution was applied directly to the filter before a thin glass slide was mounted on top. The slide was mounted to the microscope, and first a 40x objective was used to find the correct focus before switching to the 100x objective. When switching to the 100x objective, a drop of immersion oil was added on top of the slide, and the microscope was refocused. A total of 30 BCZ square counts was made per filter/sample to make a BCZ square average value for each filter. These values were then converted to cells per mL per OD value following equation 2, below. These values were plotted into a growth curve using Microsoft Excel.

$$Cells\ mL^{-1}OD^{-1} = \frac{avg.cells\ per\ BCZ\ square * 2.01 * 10^6 * Dilution}{Volume\ of\ cell\ sample\ on\ the\ filter\ (mL)} \quad (eq. 2)$$

*The number 2.01\*10<sup>6</sup> multiplied by the BCZ square area is the area of the Anodisc filter.*

## **Cell Count by Flow Cytometry**

A flow cytometer is a machine that are used to count cells in a solution, preferably fixed cells. Its downside is that it only works for single cell strains and is best used for pure cultures. The flow cytometer suspends single cells which forces them to pass through a laser one at a time. Thereafter, the flow cytometer counts them correctly if the solution is properly diluted. Cells can also be stained and separated based on staining, and can show something about phenotypes. Colouring DNA can give chromosome number per cell. When hitting a cell, the laser produces forward scatter (FSC), which tells about size, and side scatter (SSC), which tells about cell density. By recording counts, this event is put into a plot

with y-axis being forward scatter and x-axis being side scatter. This plot will provide information about subpopulations, and you can single these out using gates (you draw a circle around them). The program will give statistics, such as events/mL which can be used to calculate cells/mL in the original cell sample. A computer is hooked up with the flow cytometer, which is controlled and run through by a program on the computer.

The flow cytometer (Amnis<sup>®</sup> CellStream<sup>®</sup> from Luminex) was calibrated before usage by CellStream<sup>™</sup> Calibration agent. Firstly, the system was initialized in the CellStream<sup>®</sup> Acquisition program on the hooked-up pc. The calibration agent was vortexed gently, which resuspended the beads in the solution. About 150 µL were added to a 1.5-mL Eppendorf tube, which was placed in the instruments single load portal. The program was used to load the sample and to calibrate after selecting the appropriate bead lot. After creating a new experiment, the system was ready to run samples. The same formalin fixated cell samples used to count cells with UV microscopy was used for flow cytometry. Volumes extracted from these samples were calculated as such that the total amount of cells in 100 µL would be  $5 \times 10^6$ . To this volume, 1 µL of premade 100x SYBR-green stock was added, making the volume 1x SYBR-green after MQ water were added to make the total volume 100 µL (one cell sample had a too low concentration, and was made to a total of 200 µL). The sample volume was deposited into an Eppendorf tube. The open tube was placed in the single-load portal on the flow cytometer. The sample was loaded into an internal reservoir by using the program CellStream<sup>®</sup> Acquisition on a computer hooked up to the flow cytometer. FSC, SSC and 488nm (SYBR-Green) data was recorded on 50 000 counts/events. The sample volume was then deposited to a waste reservoir. To get rid of any residual cells in the flow cytometer before the next sample run, 100 µL MQ water was loaded and run for a minute before deposited to the waste reservoir as well. After all sample runs, the experiment was saved, exported to another computer and analysed with CellStream<sup>®</sup> Analysis software. The data was used to make a growth curve for aerobic and anaerobic growth.



## Experimental Protocol

The experiment consisted of measuring gas kinetics of growing *P. aeruginosa* liquid cultures during the transition from aerobic respiration to denitrification and until all the denitrification substrates are used up. The gas kinetics were monitored and recorded with the robot incubation system. Thirty numbered vials of liquid culture were incubated at the start of the experiment (table 4). During this incubation, certain vials were slaughtered (removed from the experiment and pelleted) when certain conditions are met. Examples for these conditions are: after 2 hours (to have a starting point) and another at the transition to anoxia ([O<sub>2</sub>] plummet and [NO] rise). Some supernatant after vials are pelleted was saved for nitrite measurements, the rest was disposed of. The pellets were resuspended in RNase-protect, which will hinder the degradation of RNA. Then they were pelleted again. RNA extraction was performed on the pellets, and then they went through clean-up with TURBO DNase to remove gDNA. It was performed real time PCR to check for any gDNA. When the results were less than the NTC, the RNA moved on to single strand cDNA synthesis. After the cDNA synthesis, the cDNA was quantified. Then, droplet digital PCR (ddPCR) was performed on all samples with nosZ primers and then rpoS primers.

## Preparations

Helping with the experiment was another student, since it is too huge to be monitored by one person (the experiment lasted about 40 hours). Vials were prepared before experiment start: 30 vials for anaerobic liquid culture, 3 vials with standard gas, 1 vial with pure O<sub>2</sub> and 1 vial with pure helium. They were prepared by having 30 vials with pH 7 50mL Siström's medium with a stirring magnet and 5 empty vials sealed with rubber septa and crimped metal rings. The vials with medium and 1 empty vial were helium washed. After, the 3 empty vials were evacuated. One was filled with High standard, one with NO standard, and the last with pure O<sub>2</sub>. The untouched "empty" vial contains normal air and will act as a Low standard. Two vials, separate from the ones that were made earlier, were inoculated from glycerol stock, one with PAO1 and the other with the mutant strain. The vials were put on water bath at 20 °C. The 30 helium washed vials with medium were placed in the robot

incubation system and numbered 1-30 based on placement. Table 4 shows the placement of the vials in the robot incubation machine in the water bath, and shows the treatment for each: Wt/Mut strain & 0/2.5/5 mL O<sub>2</sub>. The water bath of the robot incubation system was 20 °C, the stirring was set to around 600-700 rpm. The standards were placed in slot 31-33. These slots have no stirring, but that is not needed for the standards. Then the vials with medium were made 2mM NO<sub>3</sub><sup>-</sup> by injection of sterile KNO<sub>3</sub> solution with a syringe. From the vial of pure O<sub>2</sub>, the vials anointed 2.5 were injected with 2,5 mL pure O<sub>2</sub>, and the one anointed 5 with 5 mL. When the two inoculated vials reached OD<sub>600</sub> were 0.100, around exponential growth, the vials were ready to be used to inoculate the vials of the experiment. The vials designated Wt in table 4 were inoculated with 1mL of PAO1 liquid culture, and the Mut ones were inoculated with 1mL of the mutant strain liquid culture. The result was 5 sets of 6 different treatments. A syringe with ethanol was used to alleviate overpressure before the experiment starts.

*Table 4: Table over vial placement in the robot incubation system. Shows number, strain and treatment. Example: 9 WT(5), meaning the vial number is 9, the strain is the wildtype PAO1, and oxygen at start is 5 ml O<sub>2</sub>.*

1 Wt(0)	2 Wt(2.5)	3 Wt(5)	4 Mut(0)	5 Mut(2.5)		16 Wt(0)	17 Wt(2.5)	18 Wt(5)	19 Mut(0)	20 Mut(2.5)
6 Mut(5)	7 Wt(0)	8 Wt(2.5)	9 Wt(5)	10 Wt(0)		21 Mut(5)	22 Wt(0)	23 Wt(2.5)	24 Wt(5)	25 Mut(0)
11 Wt(2.5)	12 Wt(5)	13 Mut(0)	14 Mut(2.5)	15 Mut(5)		26 Mut(2.5)	27 Mut(5)	28 Mut(0)	29 Mut(2.5)	30 Mut(5)

## Gas Kinetics and Sampling

Before starting the robot incubation system, there was a checklist to go through. The pc was rebooted to avoid software crashes. The vacuum pump connected to the NO-analyser was checked if they were plugged in. The NO-analyser was switched on, it takes a while before it is ready. Magnetic stirrers were turned on (600-700 rpm), the water bath was turned on and the needle was replaced.

Initializing the robot incubation system was a multistep procedure. To initialize the GC, a program called "Varian uGC" was opened, a user was selected and the experiment was launched. A new sequence was created, and method selected. A sequence run was

created, and a status bar will read waiting for trigger which indicates that the GC was initialized. A python program was launched and the bath was imported (so the program knows the size of the bath). Then a cycle was started and a path was selected for saving NO data. To check that the system works, the standards were sampled once. To start the experiment, the position of the first vial, the number of vials, and the amount of cycles were selected. Since the experiment was continuous, the amount of cycles was set to a very high number, which will keep it going until we decided the experiment was over. During the experiment the robot incubation system will sample gas from the headspace of vial 1 through 33, this is one cycle. The data was automatically saved to the experiment, and roboplot plotted the data in real time as it was acquired. This was used to determine the transition to anoxia, and what step of denitrification was being active. This information was used to determine when a vial was to be slaughtered.

Different vials were set up to be slaughtered at different points based on where in the denitrification process the cultures were. When the conditions were met for a vial, then the vial was slaughtered (removed from the robot incubation system and pelleted). Vial 7-9 and 22-30 were slaughtered after at 2-hour mark, the standards are moved to slot 7-9. Vial 16-21 was slaughtered at the transition to anoxia (O<sub>2</sub> plummets, NO rises). Vial 10-15 were slaughtered at the N<sub>2</sub>O peak. Vial 1-6 were slaughtered at the end of the experiment, when all N<sub>2</sub>O was reduced and N<sub>2</sub> stopped increasing.

Before pelleting the liquid cultures, OD<sub>600</sub> was measured of each vial. Then, the 50 mL liquid culture in each vial was split into four equal volumes: between four 50 mL falcon tubes (3 destined for RNA extraction, the last 1 for protein extraction). When a tube or container was marked, it means there was written the sample number on it, which is the vial number plus a distinction number/text (vial 1 would make: 1-1, 1-2, 1-3 and 1-prot). The tubes were weighed and it was made sure two and two tubes had the same weight (less than 0.1g difference). The contents of the tubes were then immediately pelleted by centrifugation with a precooled (4 °C) Beckmann centrifuge at 10 000g for 10 minutes. 10 mL total of supernatant was saved as a protein sample per vial in a marked 15mL falcon tube, which was frozen at – 20 °C. The rest of the supernatant was disposed of in bacterial waste. The pellets were resuspended in 1 mL RNase-protect. Not all pellets were visible after pelleting. Therefore, the RNase-protect was reapplied multiple times at the inside at

the bottom of the falcon tubes to make sure the pellet would be resuspended. The suspensions were transferred to new Eppendorf tubes, and after 5 minutes the suspensions were pelleted again with an Eppendorf MiniSpin 12 Place Benchtop Centrifuge. The supernatant was decanted entirely, and the pellets were stored at -20 °C.

This is a good time to mention a known error source: vial 18 was mistakenly not inoculated at the start of the experiment. To compensate for this, when it was time to slaughter it, vial 3 was slaughtered instead. This was possible due to them being the same strain-treatment, a duplicate. However, this only postponed the problem. When another duplicate, vial 12, was to be slaughtered, only half the volume was harvested and it was put back into the robot incubation system replacing vial 3. Only extracting half of the liquid culture and reusing the rest as a replacement, introduced several instances of piercing the septum. The liquid had to be extracted by syringe through the septum, and helium from a pure helium vial had to be injected in equal volume. The gas kinetics and vial numbering have been corrected and masked post-experiment.

Also done post-experiment, the data from the gas sampling was put into a Master spreadsheet made by the nitrogen group at NMBU. The file and tutorials can be found at their NMBU research page ([NMBU Nitrogen group, 2019](#)). The tutorials go through how to import data, how to calibrate the spreadsheet and more.

## Nitrite Measurements

Nitrite measurements were performed on the sampled supernatant. After thawing and vortex, 100 µL were extracted into marked Eppendorf Tubes. There were made 1mM, 0.5mM, 0.1mM, 50 µM, 10 µM, 5 µM, 1 µM and MQ water standards. The NO-analyser was initialized, and when it was ready the chemical setup was readied as described under **robot incubation** section. When pulling sample/standard, the liquid was mixed by aspirating and expelling the liquid using the syringe. Between each injection of sample into the chemical setup, MQ water was aspirated and expelled into a sink a few times (5-10 times). 10 µL of each standard were injected with a glass syringe, and the returned values was written down. Then the same was done for the samples, but during the series of measuring the 10

μM and 1 μM standard were tested again in the middle and at the end of the series. A standard curve was made and the nitrite concentrations were calculated.

### **RNA Extraction, Turbo DNA-free Treatment and Reverse Transcription**

All surfaces and equipment were sprayed with RNase free prior to usage, all tubes were RNase free and samples were kept on ice. For cell lysis, the FastPrep-24 was used with screw lid tubes. The pellets were suspended in 600 μL RLT buffer 1% β-mercaptoethanol (β-ME), vortexed and dispartaged with a syringe if necessary, then 0.5g glass beads of size 0,1 mm were added. The cells were lysed by FastPrep-24 at 6.5 m/s for 2 x 30 seconds, with 2 minutes on ice in between to prevent high friction temperatures. The tubes were then centrifuged at max. rpm (14 000 rpm) in the MiniSpin for 5 minutes. The supernatant was transferred to new, marked Eppendorf tubes. RNA extraction was performed on all lysed cell samples after the protocol for [RNeasy MiniKit by QiaGen](#) (p27-34). The protocol includes using RNeasy membrane spin columns and buffers to clean up the RNA, and finally elute it with RNase free water. This resulted in 50 μL RNA samples. The RNA samples were stored at -80 °C, to prevent degradation before they could be reverse transcribed.

To remove leftovers of genomic DNA (gDNA), the RNA samples were treated with the Turbo DNA-free kit. The 50 μL RNA samples were added 5 μL 10x reaction buffer and 1 μL Turbo DNase from the kit. The samples were pipetted slowly up and down a couple of times to mix them properly. The samples were incubated at 37 °C for 60 minutes on a preheated thermal shaker (without shaking active). The inactivation reagent was flicked which re-suspended it, then 10 μL was added to the samples. The samples were incubated for 5 minutes at room temperature, while being flicked often to resuspend/mix the inactivation agent. The inactivation reagent was pelleted using MiniSpin at 10 000 x g for 1,5 minutes. The supernatant was transferred to new marked 1,5 mL Eppendorf tubes without transferring any precipitate. The samples were then investigated through real time PCR and for samples that had gDNA after the Turbo DNA-free treatment, was treated again with higher amounts of Turbo DNase: 2 x 1,5 μL; one application at the start of incubation, and the other at the 30-minute mark. The amount of RNA yield was measured by Qubit RNA HS assay (Quick reference. Qubit assays. Pub. No. MAN0006880. Rev. 1.0.).

Using Maxima First strand cDNA Synthesis kit, reverse transcription of the RNA samples was performed. The reaction volume was prepared in marked PCR tubes. Each reaction volume contained 4 µL 5X reaction mix, 2 µL Maxima Enzyme Mix and 14 µL template (RNA sample): total volume 20 µL. The volume was mixed gently, mildly centrifuged and ran with the program in table 5. The samples were diluted to 50 µL (2.5x dilution) with RNase free water. The resulting cDNA samples in PCR tubes were kept in a -20 °C freezer.

*Table 5: Table over Maxima First Strand cDNA synthesis thermal cyclor program. There are no cycles in this program. The last step was for preservation of the cDNA samples.*

Step	Temperature (°C)	Time (minutes)
1	25	10
2	50	15
3	85	5
4	4	∞

### **Droplet Digital PCR**

Droplet digital PCR (ddPCR) uses water-oil emulsion droplet technology. A sample is split between droplets, then there is done PCR amplification in each droplet. EvaGreen was the staining dye used in this method in this experiment. In droplets where there has been PCR amplification are regarded as positive droplets, and the others are regarded as negative. By counting positive and negative droplets, a total quantification of genes can be done. This works by the premise, that a single copy of a targeted gene resides in each positive droplet. The ddPCR system used was the Bio-Rad QX200™ Droplet Digital™ PCR system, comprised of a droplet generator and a droplet reader. In addition to these machines, a thermal cycler and a PCR well plate sealer were needed.

Before performing ddPCR, real time PCR was performed on 1 µL of cDNA sample to estimate the amount of *nosZ* copy numbers. Then ddPCR were performed with dilutions on 7 samples of ranging copy numbers based on the real time PCR data and a table with dilutions for ddPCR was prepared. Then ddPCR was performed on all 78 samples in a PCR

well plate (96-well) with the *nosZ* primer pair, twice. Then a plate with the *rpoS* primer pair. The plan was to run all primer pairs twice (addendum table A2), but the experiment was cut short due to a severe malfunction in the droplet generator. This malfunction might have impacted the *rpoS* data, but *nosZ* data looked like it was in perfect order.

The first step in the protocol was to make separate dilutions for each sample in new PCR tubes. The dilutions were calculated by using data from the real time PCR and the dilutions that seemed good when testing some of the samples on the ddPCR system. More specific, the 7 samples with their real time PCR copy number was plotted against the dilutions that was decided to be good for them. Using a standard curve approach, all copy numbers of *nosZ* from the real time PCR was converted to a dilution factor (example: 66x). These factors were then round up or down to nearest 5x/10x multiplier (example: 66x= 50x), to make it easier to dilute a huge number of samples.

After all the dilutions were made, primer stocks were thawed. A PCR 96-well plate were setup with 80 reactions, 78 samples and 2 NTCs. The reaction volumes were setup according to table 6, while working on ice. This was done by making a master mix everything except the samples (cDNA template), then depositing 20  $\mu$ L of the master mix in each well and finally applying 2  $\mu$ L of cDNA sample to its respective well. All PCR plate was transferred to the droplet generator workstation. The droplet generator operates with DG8 cartridges, which contains 3 rows of wells and hooks for a gasket. The bottom row is for droplet generation oil, the middle row is for samples and the upper row is for the emulsion that is made by the machine. When transferring sample to the cartridge, the pipet tips are to be slid down on the inside of the well at a  $\sim 15^\circ$  angle until they pass the ridge at the bottom of the wells. Still holding the angle, dispense half the sample very slowly. After dispensing half, slowly move the tip along the wall while dispensing the rest of the sample. Do not push the pipet plunger beyond the first stop, to prevent air exhausting into the well. The transferal of the droplet emulsion, created by the droplet generator, into the ddPCR Bio-Rad 96-well plate must be done correctly. The pipet tips should hold a  $\sim 45^\circ$  angle against the junction where the side walls meet the bottom of the well. The 40  $\mu$ L of droplets are to be slowly drawn over a period of 5 seconds. While dispensing the droplets, over 5 seconds, into the 96-well plate, position the pipet tips vertically and pressing lightly into the side wall of the well near the bottom. Being careful when pipetting, sets of 8 samples were transferred with

an 8-tip pipette to the middle wells of a DG8 cartridge. The oil wells, bottom row, were each filled with 70 µL of droplet generation oil. A gasket was hooked over the wells of the cartridge. The sliding lid on the droplet generator was opened, the cartridge was loaded into the droplet generator and the lid was closed (the lid is operated by a button). When it was closed and detected the loaded cartridge, it automatically started generating droplets. While the machine worked, the next DG8 cartridge was prepared. When the droplet generation was complete, the cartridge was removed, and the new one loaded. While the machine worked on the new cartridge, the droplet emulsion from the first cartridge was transferred carefully to the new Bio-Rad 96-well PCR plate and the old cartridge was discarded. To prevent evaporation and contamination of the droplet samples, the wells that got sample were taped over with a strip of tape while working. This continues until all samples, 80 wells, were done.

*Table 6: shows the contents of the reaction volume for ddPCR with EvaGreen SuperMix.*

Component:	Amount:
2x EvaGreen SuperMix	11 µL
2 µM Forward primer	1 µL
2 µM Reverse primer	1 µL
Water	7 µL
cDNA template	2 µL
Total:	22 µL

After droplet generation, the tape was removed and the plate was sealed with a pierceable metal foil. This was done using a plate sealer, which heats up a press that gets pressed against the foil on top of the well plate. After sealing the plate, the plate was put in a thermal cycler. The thermal cycler program for EvaGreen ddPCR with the primers that was used can be seen in table 7. Twenty minutes before the program was finished, the droplet reader was initialized. When the program was done, the plate was inserted into the droplet reader. Controlling the droplet reader was the QuantaSoft™ software on a connected PC. Absolute quantification was chosen as the experiment, and a plate setup was made. All



samples must be marked with the experiment, the reagent (EvaGreen), and sample type (unknown, not so important). The droplet reader was started and it counted the amount of positive and negative droplets in all the samples. All the data was saved, and analysed with QuantaSoft™ Analysis Pro.

*Table 7: Shows the thermal cycler program used for EvaGreen ddPCR with the primers that was used. The thermal cycler program moves through each step, from top to bottom. The table shows the temperatures, how much time (seconds) they are held for each step. It also shows how many cycles that certain parts are repeated (blank means no cycles; it will be performed once).*

Step purpose	Temp	Time	Cycles
Enzyme activation	95°C	5min	
Denaturing	95°C	30sec	40 cycles
Annealing	60°C	30sec	
Extension	72°C	30sec	
Signal	4°C	5min	
Stabilisation	90°C	5min	
Hold(preservation)	12°C	∞	

## Western Blotting

A western blot is an analytical technique used on proteins. The protein sample is denatured before a gel electrophoresis is performed on it. Target proteins can be visualized on the gel by using a primary antibody that binds to the target proteins, and a secondary antibody that binds to the primary antibody and emits a signal. Chemiluminescent detection was used in this experiment: the signal was triggered by a substrate coming in contact with the reporter on the secondary antibody. The protein that was blotted for was NosZ.

First the cell pellets designated for protein analysis was lysed. About 0.2 g of glass beads were measured into marked microtubes with screw cap. The cell pellet was dissolved in 300 µL lysis buffer (20 mM Tris-HCl pH8; 0.1% v/v Triton X 100, 200 mM NaCl, 1 mM DTT). After dissolving the cell pellets, they were transferred to the microtubes with glass beads. The tubes were run in the FastPrep24 for 3\*60 seconds at max speed, with the tubes cooling

on ice for 2 minutes between each 60 seconds. After lysis, the tubes were spun down for 1 min at 10 000 x g in a MiniSpin. 200 µL of the supernatant was transferred to new, marked epi tubes.

Before gel electrophoresis, a BCA protein assay was performed. The spectrophotometer already had saved standards which was picked instead of making new ones. A BCA working solution was made for The Pierce™ BCA protein assay kit. The working solution consists of 50 parts of reagent A and 1 part of reagent B (50 A + 1 B). Per sample was made two marked tubes, one is for a non-diluted sample and the other is for a 10x diluted sample. 1mL of BCA working solution was pipetted to each tube, 50 µL sample was pipetted to the tubes for non-diluted samples and 5 µL sample + 45 µL MQ water was pipetted to the tubes of diluted samples. The contents in each tube were mixed by pipetting up and down 5 times. The tubes were closed and placed on a heating block for 30 minutes at 60 °C. The spectrophotometer was initialized, the wavelength was set to 562 nm, a recently made standard curve using the same kit and protocol was selected and the instrument was zeroed with a cuvette containing 1mL working solution. After the 30 minutes had passed, the tubes were cooled to room temperature and the absorbance was measured. Because a standard curve was selected, the instrument calculated the concentrations which was written down. The reason for the BCA assay was to acquire data to make dilution of any high protein concentrations to 2mg/mL. However, the protein concentrations were low and this was not necessary. Therefore, the max volume of 45 µL was used in the following gel electrophoresis.

The gel electrophoresis method used was sodium dodecyl sulphate – polyacrylamide gel electrophoresis (SDS-PAGE). This method separates proteins by mass. The gels used in this experiment were the Mini-PROTEAN® TGX Stain-Free™ Precast Gels. The gels have a tape at the bottom of the cassette, the plastic frame holding the gel, that must be removed before a run. After removing the tape, the gel was inserted into a gel casting stand, which was then mounted into a Mini-PROTEAN® Tetra Vertical Electrophoresis Cell. The well comb was removed. Tris-glycine buffer was filled to the 2-gel mark on the cell and filled the space between the two gel slots in the casting stand (if one gel was run, the other side had a plastic frame dummy). 45 µL of sample was mixed with 15 µL 4x reducing buffer in new Eppendorf tubes, this was also performed on a NosZ positive control. Then, the tubes were

closed and incubated for 5 minutes at 90 °C in a heating block. After incubation, 15 µL the samples and the NosZ positive were loaded onto wells in the gel. An Invitrogen™ BenchMark™ Protein Ladder and a MagicMark™ XP Western Protein Standard were loaded onto the gel, flanking the samples. The gel was run at 270V for 15 minutes. After the run, the gel cassette was opened with an opening lever (supplied with the gels). The gels were carefully taken out of the frames and placed in buffer (TBS) to prevent it from drying out. Using the Gel Doc™ EZ system, a stain free picture was taken of some of the gels. The gels were placed on the Stain-Free Sample Tray that comes with the system. The tray is then inserted into the machine, and using the Image Lab™ software an image was taken and saved.

Before performing western blot, the proteins were transferred to a nitrocellulose membrane using the iBlot™ 2 system. This was done by assembling the iBlot™ transfer stack with a pre run gel, loading it into the machine, selecting the appropriate program (P0 for this experiment) and running the device (Quick Reference: iBlot 2 Dry Blotting System by Invitrogen). The run takes 7 minutes. After the run, the membrane with the proteins are recovered and the rest of the transfer stack is discarded. The membrane was kept in TBS buffer until western blot. Before going on with the western blocking, all the required buffers were made. Per blot: 30 mL blocking buffer (Tween TBS with 1 % bovine serum albumin [BSA]), 2 x 5 mL binding buffer (Tween TBS with 0.5 % BSA) and 8 x 30 mL washing buffer (Tween TBS, no BSA). Western blot was performed using the SNAP i.d. 2.0 System. The system uses a vacuum pump to draw buffer through the membrane. After making the buffer, the membrane was put in a Snap i.d. 2.0 mini blot holder and mounted into the SnapID frame. 30 mL blocking buffer were poured onto the membrane in the frame. The pump was turned on, the frame was pressed down and vacuum was applied by turning the vacuum knob. When the frame was empty, both the knob and the vacuum was turned off. 1 µL of primary antibodies (anti-NosZ antibodies) were added to one of the 5mL prepared binding buffer, it was mixed and then poured into the frame. After an incubation period of 10 minutes, vacuum was applied until the frame was completely dry. The membrane was then washed 4 times: while the vacuum is still running, 30 mL washing buffer was poured into the frame. When the frame was empty, another volume of washing buffer was added. After the 4<sup>th</sup> wash, the vacuum was turned off. 1 µL of secondary antibodies (anti-chicken

HRP conjugated antibodies) was added to the last volume of 5 mL binding buffer and poured into the frame. After another 10-minute incubation period, the vacuum was turned on. Another 4 washes were performed like earlier, and then the blot was complete. The membrane was recovered and incubated with 3,3',5,5'-Tetramethylbenzidine (TMB) substrate before visualizing with a Chemiluminescence detection system. Images was taken of the chemiluminescence. The first blots didn't show any chemiluminescence. After stripping the membrane and doing a new blot with new secondary antibodies, still no chemiluminescence. Redid on new membrane, no result. After stripping the membrane again and changing from TMB substate to a western blotting luminol reagent, chemiluminescence was detected. However, the entire blot was smudgy and the NosZ positive control was a huge smear (addendum figure 2). The reason for this could be a bad stripping, or something else. There was not enough time to make more western blots.

## RESULTS AND DISCUSSION

### Securing a Pure Culture

The gel electrophoresis performed gave the expected bands (addendum, table A1) for the PAO1 and the *-rhII -lasI* mutant (figure 5). The PAO1 samples were in well 3 and 6, the mutant samples were in well 4 and 7, and the NTCs with primers were in well 5 and 8. The ladders flanking the samples are clearly visible and the NTCs gave no signal. The 3<sup>rd</sup> well gave the expected band at 999/1000 bp. The 4<sup>th</sup> well gave the expected band around 500 bp. The 5<sup>th</sup> well gave the expected band at 850 bp. And finally, the 6<sup>th</sup> well also gave the expected band around 400 bp. This confirms the success of growing a PAO1 culture and a mutant culture, which is good news for the earlier made glycerol stocks of these strains. Furthermore, this also confirms that the primers work.

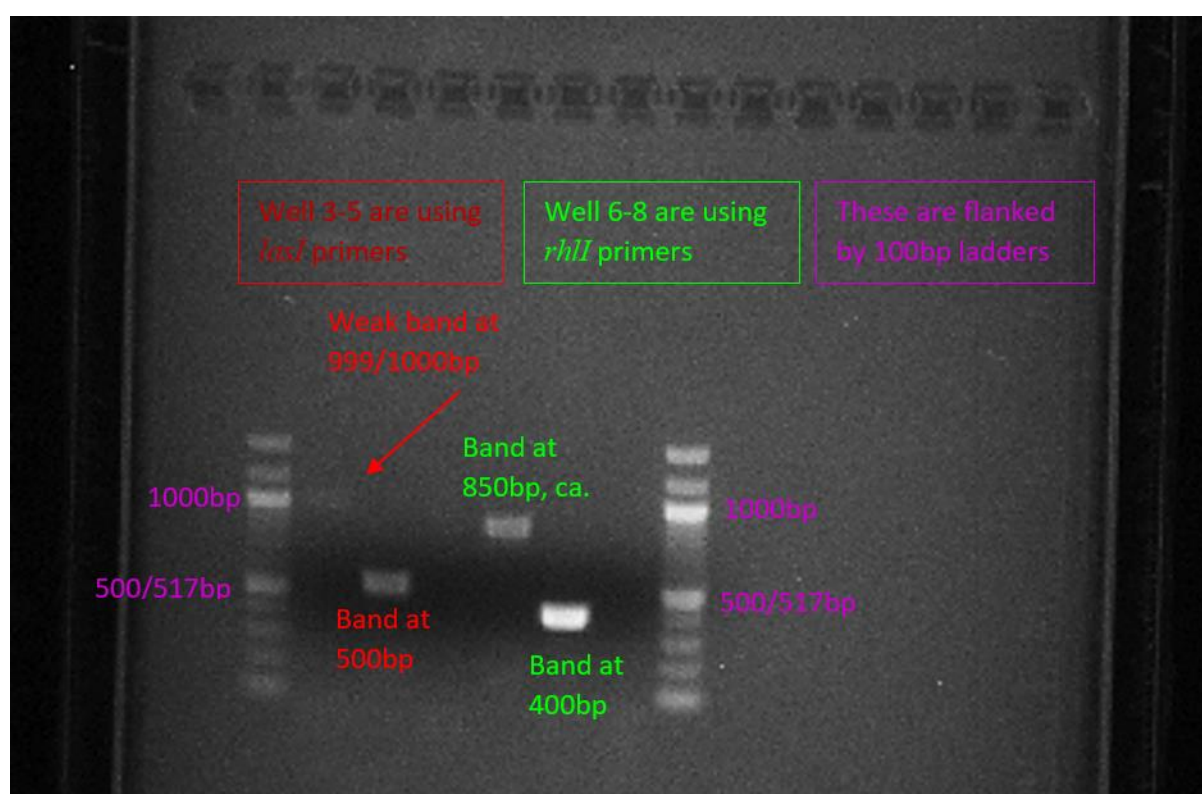

Figure 5: UV imaging of the agarose gel. PAO1 and *-rhII -lasI* mutant strains were tested with *rhII* and *lasI* primers (addendum table 1A). The PAO1 samples were in well 3 and 6, the mutant samples were in well 4 and 7, and the NTCs with primers were in well 5 and 8. The rest is explained in the picture. The ladder used was Quick-Load Purple 100 bp DNA ladder from New England's BioLabs Inc.

## Test of new primers

The results on the new primer pairs for *rpoS*, *narG*, *nirS*, *norB* and *nosZ* shows that the gel electrophoresis was successful. The results show that both the PAO1 and mutant had all the denitrification genes and *rpoS*, a gene for RNA polymerase, sigma S. This further attest to the growing the correct cultures. Again, the NTC gave no signal and the ladders are also clearly visible. A thing to note that is more visible in this gel image than the other is the curving on the bands. This might be due to not using fresh TAE buffer, resulting in weird behaviour under high temperature of longer runs. This does not impact the results, however, since the mere presence of bands

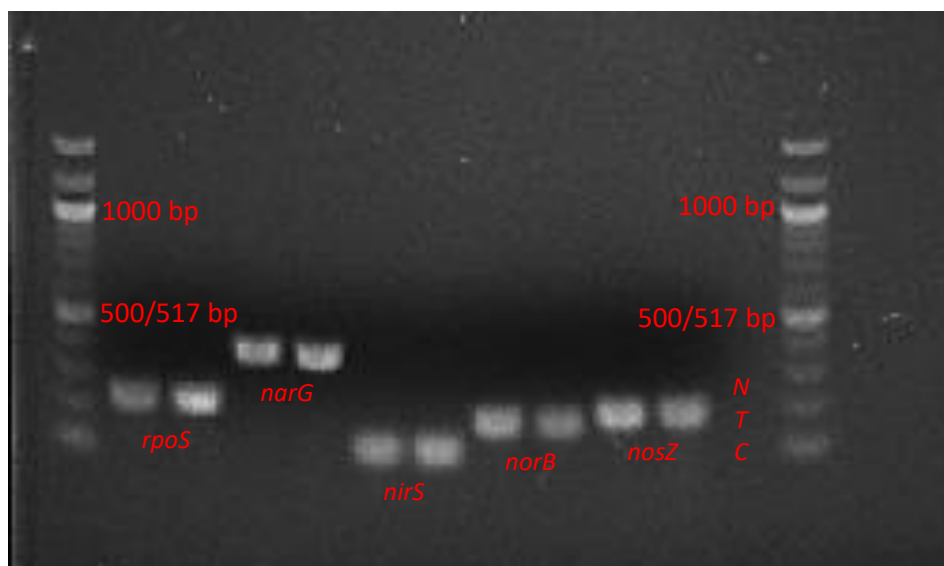

Figure 6: UV imaging of the agarose gel. PAO1 and *-rhlI -lasI* mutant strains were tested with *rpoS*, *narG*, *nirS*, *norB* and *nosZ* primers (sequences can be found in addendum table A2). The ladder used was Quick-Load Purple 100 bp DNA ladder from New England's BioLabs Inc.

## Growth curves

By monitoring OD<sub>600</sub> of several vials and sampling them at certain thresholds, samples of cultures of varying points in time during exponential growth was secured. The measurements and sampling did not extend beyond exponential growth, since the experiment would not. Cells were counted for all the samples with UV microscopy and flow cytometry, and converted into cells/mL. By combining cell counts and the OD<sub>600</sub> measurements, four growth curves were made. The growth curves for each treatment

Quorum sensing in the opportunistic pathogen *Pseudomonas aeruginosa* regulates N<sub>2</sub>O reduction

(aerobic/anaerobic) were made per method was put together in one plot (figure 7). It is worth noting that the sampling was done on PAO1 cultures that were incubated on 20 °C with around 600 rpm magnetic stirring, and thus the growth curves are only most accurate for PAO1 under these conditions.

These growth curves can be used to convert OD<sub>600</sub> into cell concentrations. By the UV microscopy method, the slope is 1,56E+09 for anaerobic culture and 1,06E+09 for the aerobic. The flow cytometry gave a slope of 1,21E+09 for the anaerobic culture and 8,22E+08 for the aerobic culture. Two things can be gleaned from this. Firstly, flow cytometry gives less cells per OD<sub>600</sub> than the UV microscopy method does. Based on the R<sup>2</sup> values, it seems that counting by UV microscopy gives more plausible growth curves. *P. aeruginosa* likes to aggregate, and it may be that the flow cytometry method is more prone to error when it comes to aggregates. After all, a human can deduct and possibly count all the cells in an aggregate under the microscope while the flow cytometer will probably create outlier events. These events are usually separated from the population showing in the analysis program, based on them giving different scatter intensities and more absorbance. It may be that they are not counted at all when counting the cells in the detected populations, and this would clearly give a lower count than UV microscopy would. Secondly, the disparity between aerobic and anaerobic is pretty clear: the anaerobic cultures have a consistent 47 % increase in cell count for each method. Under both methods, the anaerobic cultures score less cells per OD<sub>600</sub>. The cause of this would probably be a change in physiology under anoxic conditions, or to be more exact: an anoxic culture of *P. aeruginosa* produces smaller cells. This way, the cells/OD ratio would be higher than that of bigger cells. Before the growth curves was made, it was regarded as common knowledge that the bacteria were in exponential growth when OD<sub>600</sub> = 0.100. This would result in a population of around 1E+08 cells for *P. aeruginosa*.

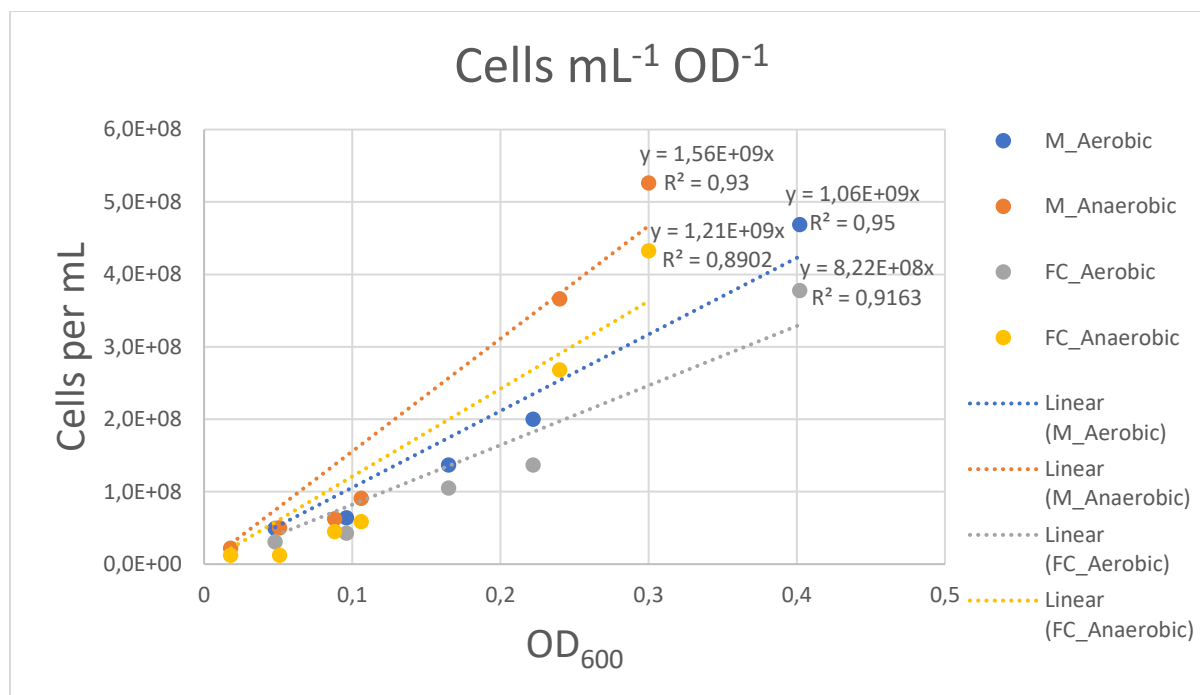

Figure 7: Shows a graph of cells per mL over OD<sub>600</sub>. The information is based on counts from UV microscopy and from flow cytometry. There are trendlines for each treatment (aerobic/anaerobic) and count method (Microscopy/Flow cytometry [M/F]). The growth curves are forced through origin ( $y=0, x=0$ ).

## Main experiment

The purpose of the main experiment was to find correlations between the expression of the *nosZ* gene, through ddPCR, and the activity of the NosZ enzyme by looking at gas kinetics. All the data that was collected during the experiment, the gas samples that were analysed by the robot incubation system, were used to create a series of gas kinetics graphs. There was also made a graph of *nosZ* copy numbers over time, and a graph for nitrite concentration over time. This was done for all three treatments: the graph column for the 0% oxygen at start is Figure 8, the graph column for the 2.5% oxygen at start is figure 9 and the graph column for the 5% oxygen at start is figure 10.

Figure 8 shows the graph column for PAO1 (in the graphs, PAO1=WT [Wildtype].) and the mutant with 0 % oxygen at start. (A) shows the amount of *nosZ* copies over time for 0 % oxygen at start. For PAO1 and the mutant, this rises slowly over time and the highest amount of copies is at the end of the experiment. (B) shows the OD<sub>600</sub> over time, which imply that the growth is rather slow in the start before it picks up at the end when it finally



reaches the exponential phase (log-phase) possibly a little before the 30-hour mark. Since no oxygen was added in this treatment, the flat, bottom lines make sense (C). (D) shows the nitrite concentration over time, with a peak at 17,75 hours. Picking up after the nitrite peak is the NO concentration (E) which has its second peak after the nitrite plummets. The probable cause for this is an increased expression of NirS, resulting in a much higher nitrite to NO reduction rate. The earlier peak is most likely the result of lacking enough active NorB to keep the NO concentration from accumulating that early. The NO concentration depletes sometime after the 27-hour mark. The NO was reduced to N<sub>2</sub>O, but the N<sub>2</sub>O graph (F) shows no accumulation, except for a small indent at the 5-hour mark for PAO1. A quick peek to Figure 9 (F) and 10 (F) shows high amounts of N<sub>2</sub>O accumulation for the PAO1. The only difference is the presence of oxygen at start, and it can be deduced that the transition to anoxia was smoother when no oxygen was present. While looking at the OD<sub>600</sub> graphs for all graph columns, a difference is standing out: The cultures that started with oxygen, especially 5 %, has very high values from very early into the experiment. *P. aeruginosa* thrives much better in an oxic environment, as can be seen. The resulting higher cell density means a higher protein density as well. For the cultures that started oxic, this means a much faster reduction ratio of available substrate. This could cause the intermediates, such as N<sub>2</sub>O, to accumulate to a much higher concentration before the bacteria react to it. Finally, the N<sub>2</sub> graph (G) shows a slow accumulation of N<sub>2</sub> that rises a little faster after the NO concentration plummets. The accumulated N<sub>2</sub> becomes static, when all the substrate is used up.

Figure 9 shows the graph column for PAO1 and the mutant with 2,5% oxygen. Looking at the *nosZ* transcript number per ng RNA (A) is higher than that of the 0 % oxygen treatment, in the start that is. The mutant peaks at 15,53 hours and PAO1 a little bit later at 22,83 hours. The OD<sub>600</sub> graph (B) shows a steady increase of cell density. The reason the graph probably looks more linear than a normal growth curve, is probably the initial boost from the present oxygen and a hard transition to anoxia. The oxygen graph (C) shows the oxygen was depleted at 12,5 hours, which gives merit to the previous statement. The nitrite graph (D) shows higher concentration peaks than that of the 0 % oxygen treatment, and also right after the oxygen concentration plummeted. This physiology also extends to the NO graph (E), where NO concentration rises rapidly after oxygen depletion. The NO

concentration seems to follow the nitrite concentration, suggesting the turnover rate of NO to N<sub>2</sub>O is rather high. The N<sub>2</sub>O graph (F) shows rapid accumulation for PAO1 at this very point as well, in fact it is exponential until it is suddenly depleted. The mutant however only gets a small bump at oxygen completion. Comparing the N<sub>2</sub>O values and the *nosZ* transcripts shows that the mutant should have more *nosZ* transcripts than PAO1 right after oxygen depletion. Confirming that there is NosZ activity even for PAO1 after oxygen depletion, is the N<sub>2</sub> graph (G). The PAO1 N<sub>2</sub> turnover is rather slow right after oxygen depletion, the mutant has the double amount of turnover and the rate increases faster than that of PAO1. This points to a more effective deployment of active NosZ.

Figure 10 shows the last graph column, which is for the 5 % oxygen at start. Contrary to the other treatments, the *nosZ* graph (A) shows that the PAO1 has more transcripts than the mutant from the start. The mutant catches PAO1 at 21,08 hours, though. On the other hand, the OD<sub>600</sub> graph (B) is as expected: higher amount of oxygen at start yields higher cell densities. The oxygen (C) seems to deplete only about 2,5 hours later than that of the 2,5 % oxygen treatment. A small bump of oxygen concentration is visible at the 27,2-hour mark. The nitrite graph (D) indicates earlier nitrite peaks for both strains (mutant being higher), even though the oxygen lasted a little longer. Cell density might be a bigger factor than oxygen right before oxygen depletes. The NO (E) concentration picks up fast after oxygen depletion, but PAO1 NO concentrations seem a little higher than they should be. The N<sub>2</sub>O graph (F) is similar to that of the 2,5 % oxygen treatment, but the N<sub>2</sub>O accumulation happens about 2,5 hours later due to the oxygen lasting longer. In addition, the reduction of N<sub>2</sub>O slows down at the 27,2-hour mark. The N<sub>2</sub> graph (G) shows the same trend of delay, but the accumulation of N<sub>2</sub> for PAO1 is even slower than previous treatment and the total accumulation of N<sub>2</sub>. The reason for this abnormal increase in total NO and N<sub>2</sub> and the small bump in oxygen is the consequence of compensating the vial that was mistakenly not inoculated at experiment start. The consequence was the introduction of a small volume of air. The source could have been diffusion with the helium gas in the syringe before injection and the multiple instances of piercing the septum. Anyway, this small volume of air bumped the oxygen concentration a little, which was eaten by the bacteria. The consequence of this is seen as a reduction in denitrification activity across the board, allowing accumulation of more NO and N<sub>2</sub>O before. The total increase of accumulated N<sub>2</sub> is the nitrogen that was

Quorum sensing in the opportunistic pathogen *Pseudomonas aeruginosa* regulates N<sub>2</sub>O reduction

introduced. It was good this happened at the end of denitrification with the only real consequence being prolonging the last step. The best would have been if it happened after all N<sub>2</sub>O was reduced, but this event/error was not in our control.

Quorum sensing in the opportunistic pathogen *Pseudomonas aeruginosa* regulates N<sub>2</sub>O reduction

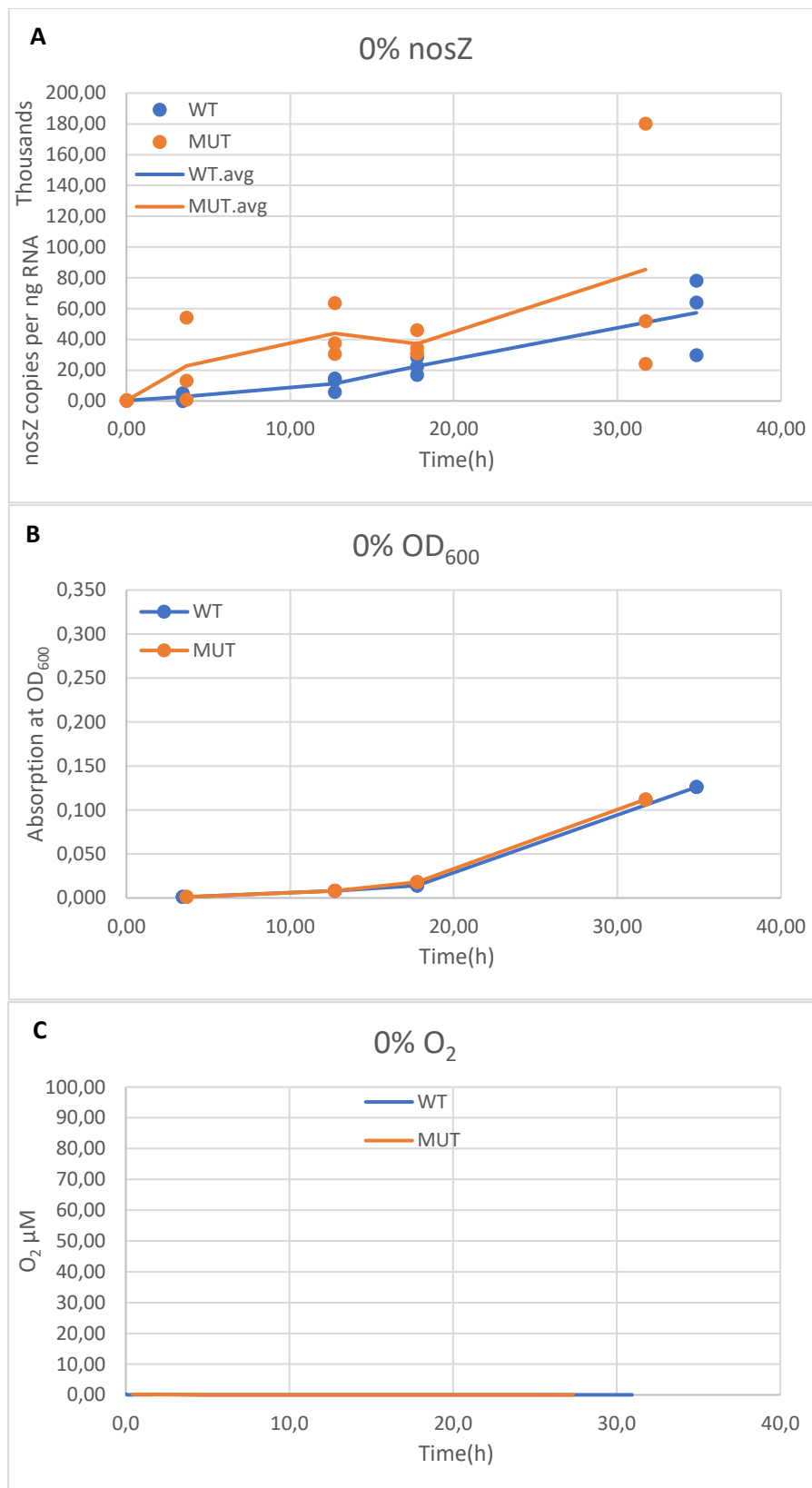

Quorum sensing in the opportunistic pathogen *Pseudomonas aeruginosa* regulates  $N_2O$  reduction

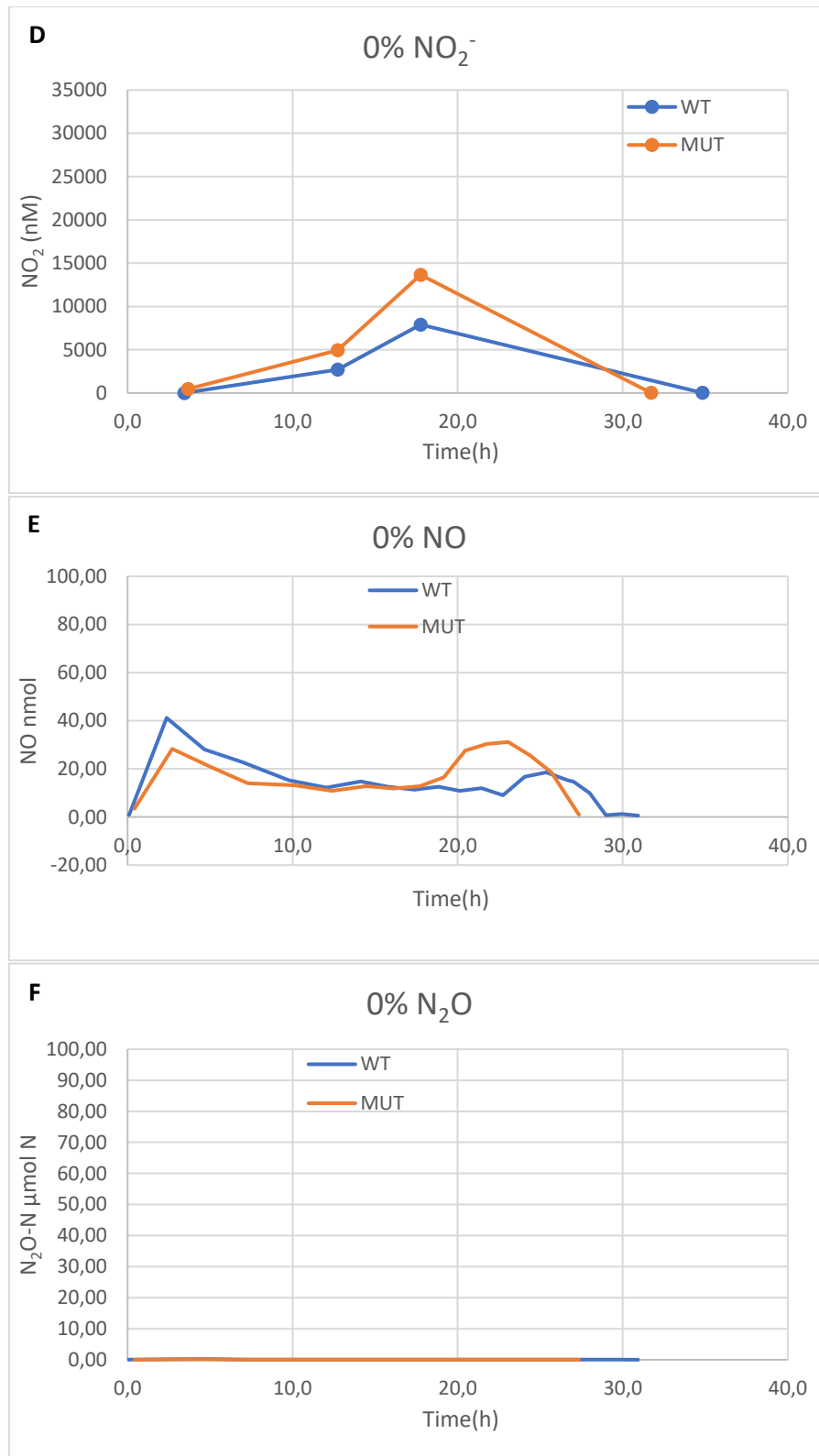

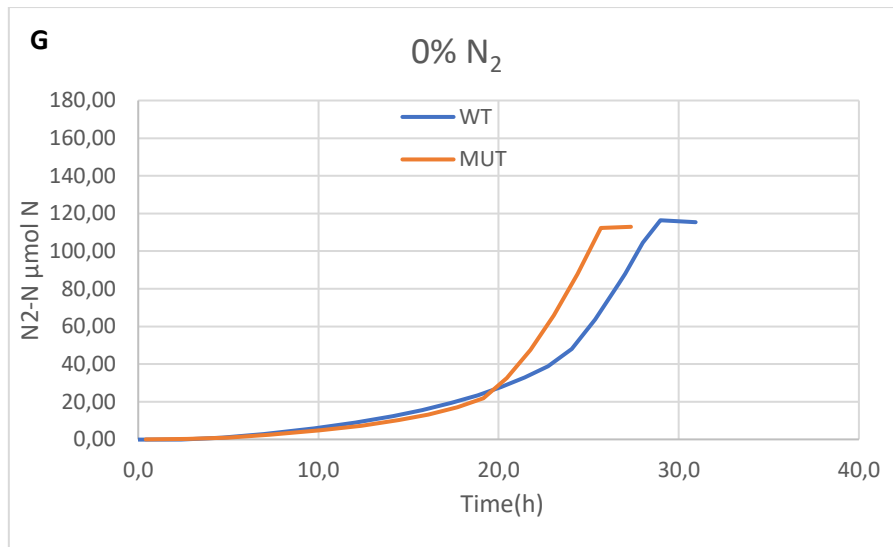
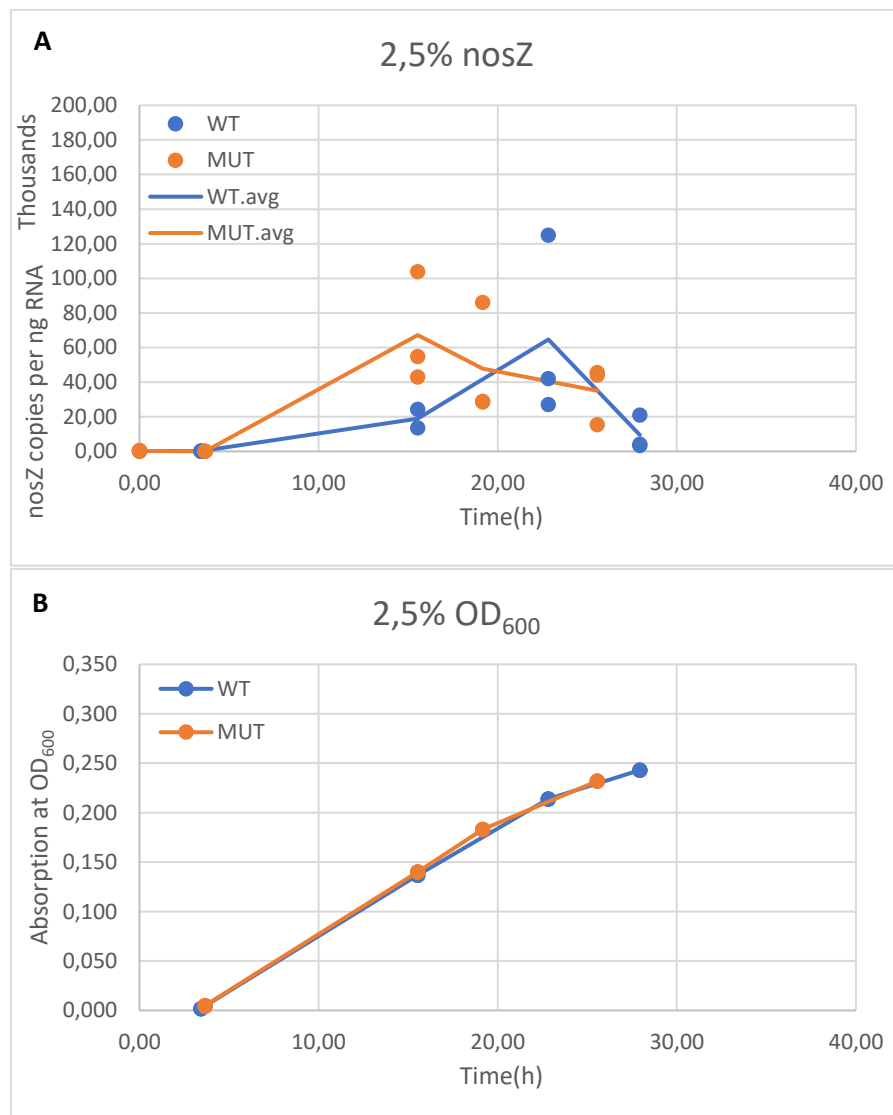
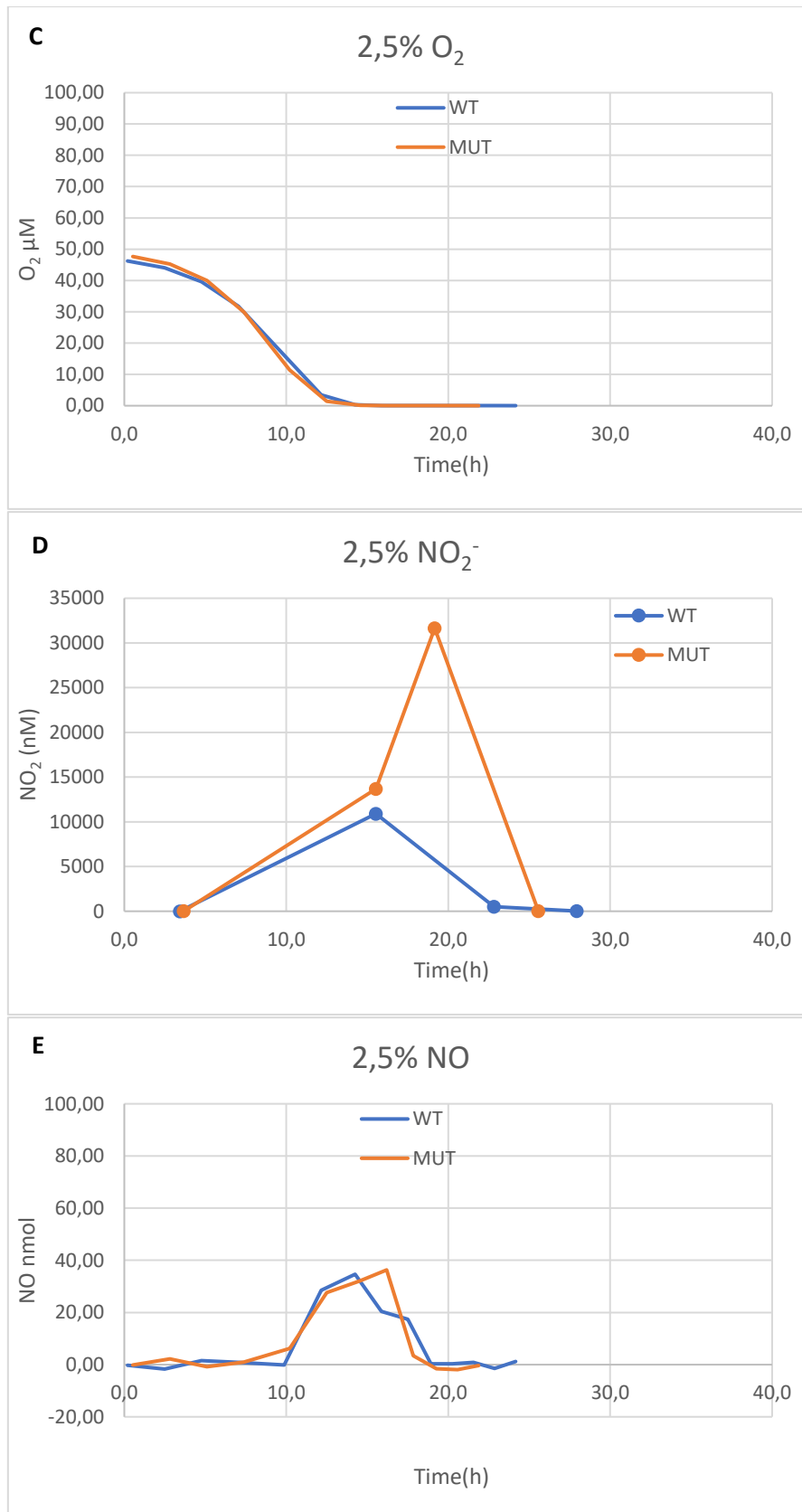

Figure 8: Graph column of data from the 0 % oxygen treatment with PAO1 and the mutant strain. Shows copy numbers of *nosZ* per ng RNA (A). Shows the OD<sub>600</sub> values of the cultures at different sampling points (B). Shows gas kinetics (C-G).



Quorum sensing in the opportunistic pathogen *Pseudomonas aeruginosa* regulates N<sub>2</sub>O reduction



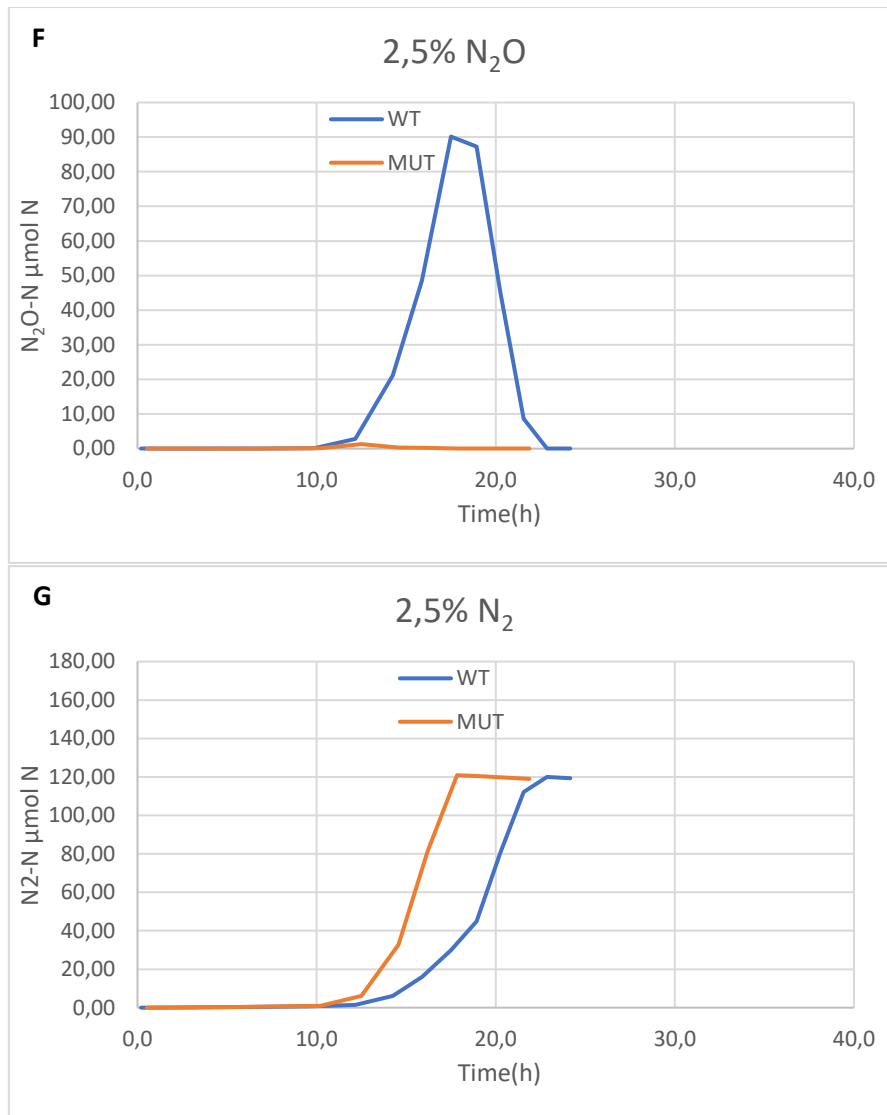
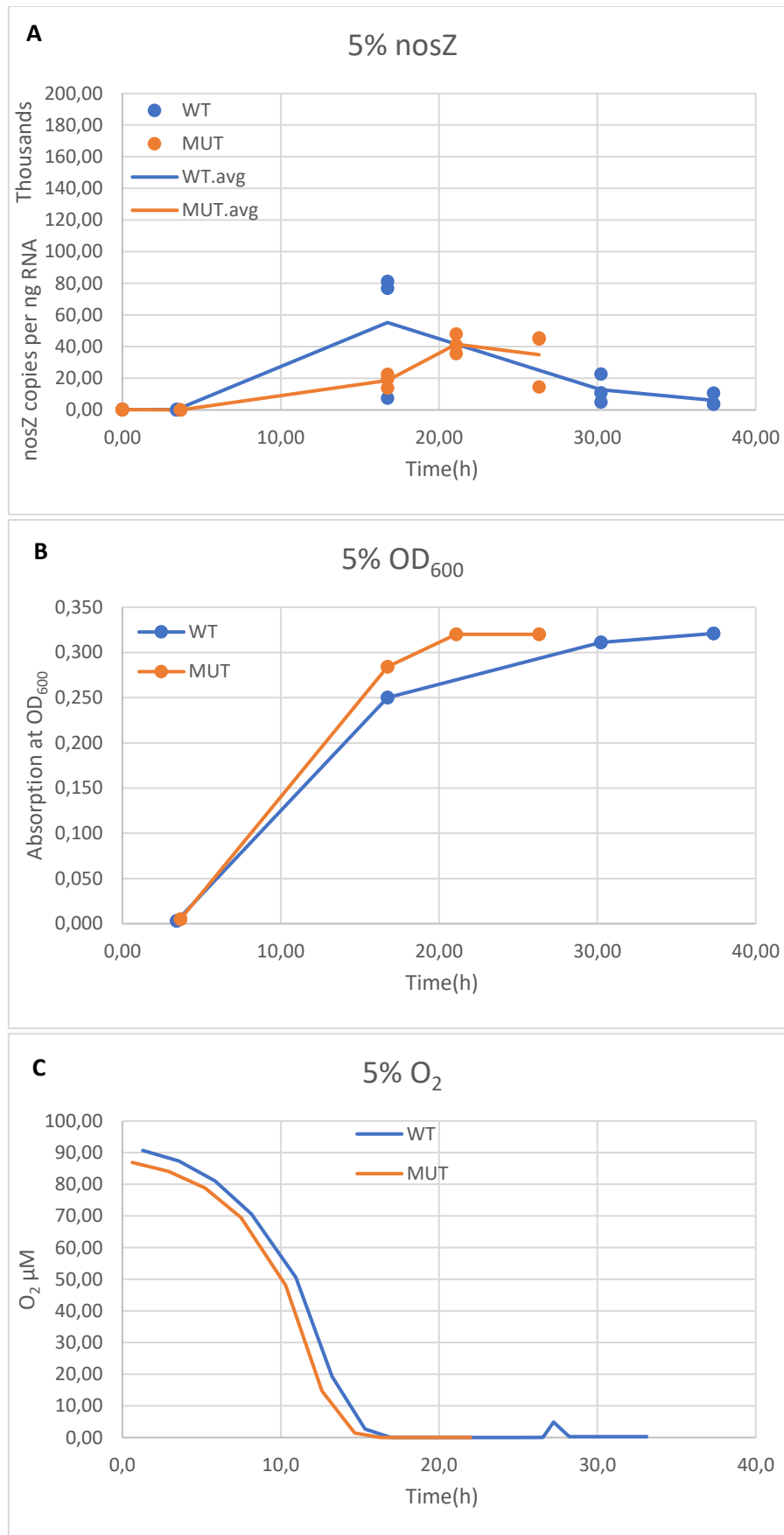

Figure 9: Graph column of data from the 2,5 % oxygen treatment with PAO1 and the mutant strain. Shows copy numbers of *nosZ* per ng RNA (A). Shows the  $OD_{600}$  values of the cultures at different sampling points (B). Shows gas kinetics (C-G).



Quorum sensing in the opportunistic pathogen *Pseudomonas aeruginosa* regulates N<sub>2</sub>O reduction



Quorum sensing in the opportunistic pathogen *Pseudomonas aeruginosa* regulates N<sub>2</sub>O reduction

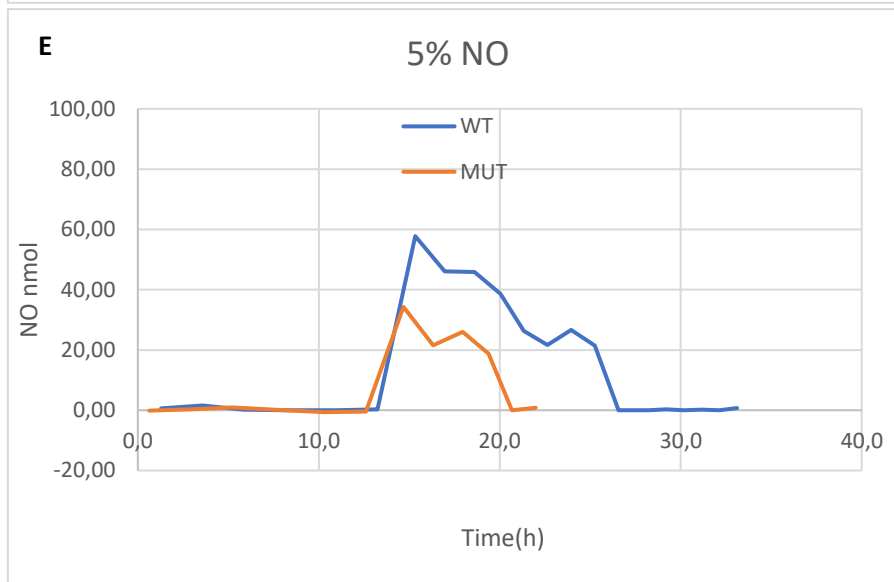
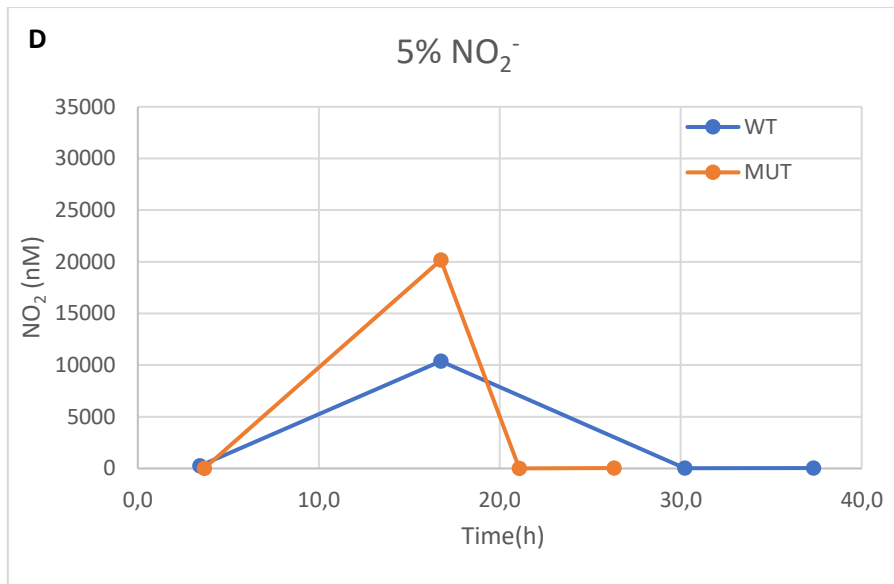

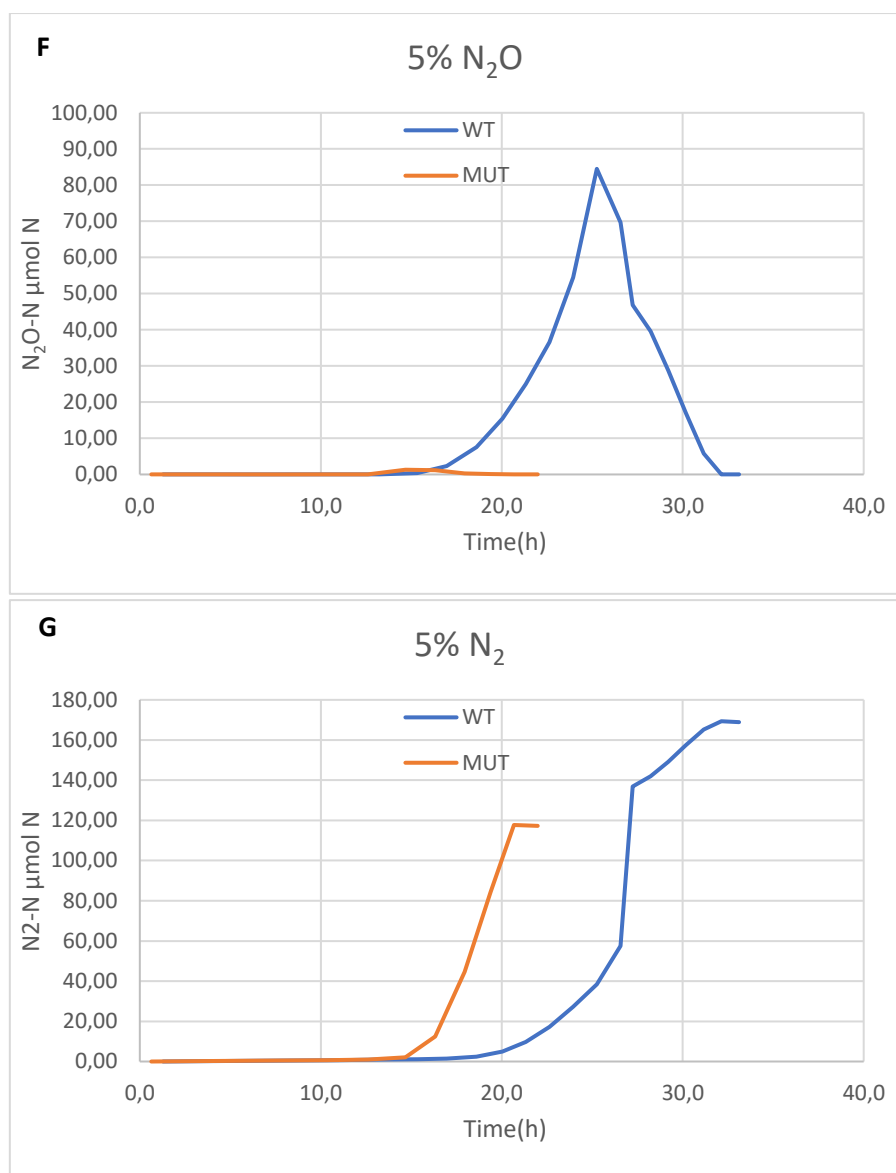

Figure 10: Graph column of data from the 5 % oxygen treatment with PAO1 and the mutant strain. Shows copy numbers of *nosZ* per ng RNA (A). Shows the OD<sub>600</sub> values of the cultures at different sampling points (B). Shows gas kinetics (C-G).

## Conclusion

Having gone through all the graphs, a couple of trends stand out. Firstly, there is not much difference between PAO1 and the mutant when they both start in an anoxic environment. However, the mutant is slightly faster at denitrification and have a small growth advantage. The reason could be the saving of energy and resources when the mutant does not have to produce the LasI and RhII enzymes and/or a faster adaptation to anoxic environment without the LasI and RhII quorum sensing systems. However, from the treatments with starting oxygen there was a huge difference: high accumulation of N<sub>2</sub>O with PAO1. In

addition, the N<sub>2</sub> turnover rate increases much more slowly in PAO1 than in the mutant strain. The question is if this is the result of reduced NosZ activity or reduced transcription of the *nosZ*. Looking at the *nosZ* transcripts of figure 9 (A) and figure 10 (A) there is a problem. In the 2,5 % oxygen treatment, the transcripts of *nosZ* per ng RNA is higher for the mutant, as hypothesized. However, in the 5 % oxygen treatment the reverse is true. This might suggest that the number of transcripts does not translate to the phenotypic difference, being the high N<sub>2</sub>O accumulation with PAO1 compared to the mutant. However, one trend is true. By removing the functionality of the LasI and RhII quorum sensing system, the mutant gets a much higher reduction rate of N<sub>2</sub>O resulting in extremely less N<sub>2</sub>O accumulation compared to the wildtype PAO1. Giving the problems with the droplet generator during the experiment, the transcript data might have become affected by this problem. This is supported by table 11 which shows the expression of *nosZ* over time, and some of the data points have a huge standard deviation seen by the error bars. This being especially true for the wildtype PAO1 with the 5 % oxygen treatment (W3 in graph). Another problem during the experiment was the inability to produce a successful western blot. If successful, the blot would have confirmed the presence of NosZ. On the more spirited side, the samples from the experiment was kept and preserved, and might in the future be properly analysed. This might give more insight.

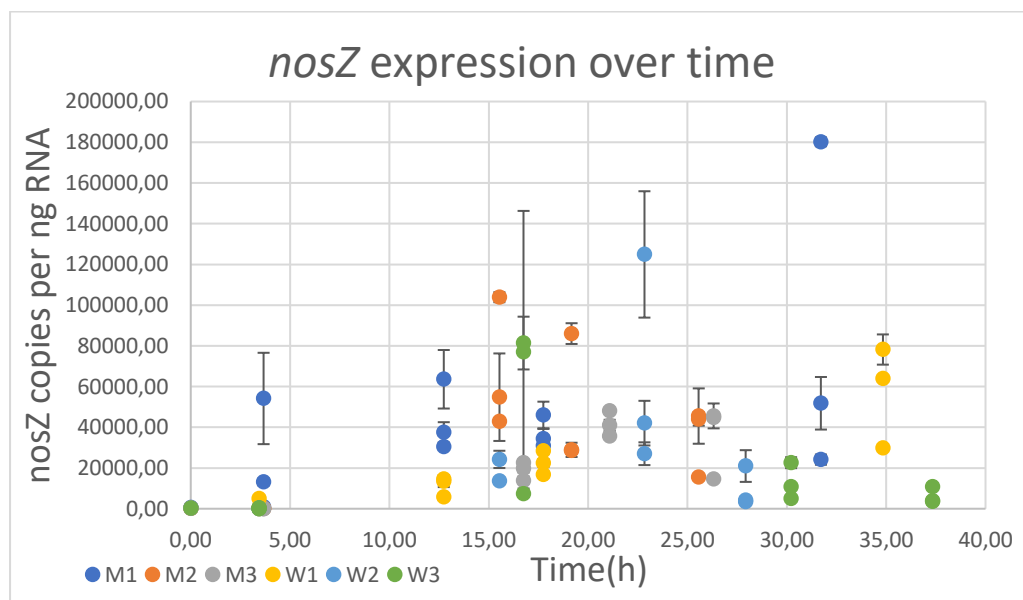

Figure 11: A dot plot showing *nosZ* expression over time for each strain-treatment combination with error bars (standard deviation). M1= mutant 0% oxygen, M2= mutant 2.5% oxygen, M3= mutant 5% oxygen, W1= PAO1 0% oxygen, W2= PAO1 2.5% oxygen and W3= PAO1 5% oxygen.

## REFERENCES

- Alhazmi, A. 2015. *Pseudomonas aeruginosa* – Pathogenesis and Pathogenic Mechanisms. *International Journal of Biology*; vol. 7, No. 2; 2015. <http://dx.doi.org/10.5539/ijb.v7n2p44>
- Alvarez, L., Bricio, C., Blesa, A., Hidalgo, A., & Berenguer, J. (2014). Transferable denitrification capability of *Thermus thermophilus*. *Appl. Environ. Microbiol.*, *80*(1), 19-28.
- Arai, H., Igarashi, Y., Kodama, T. (1995). Expression of the *nir* and *nor* genes for denitrification of *Pseudomonas aeruginosa* requires a novel CPR/FNR-related transcriptional regulator, DNR, in addition to ANR. *FEBS letters*, vol.371(1), p 73-76.
- Bakken et al., 2012. Regulation of denitrification at the cellular level: a clue to the understanding of N<sub>2</sub>O emissions from soils. *Philos Trans R Soc Lond B Biol Sci*. 1226-34. doi: 10.1098/rstb.2011.0321.
- Braker, G., & Tiedje, J. M. (2003). Nitric oxide reductase (*norB*) genes from pure cultures and environmental samples. *Appl. Environ. Microbiol.*, *69*(6), 3476-3483.
- Brown, K., Djinic-Carugo, K., Haltia, T., Cabrito, I., Saraste, M., Moura, J.J.G., Moura, I., Tegoni, M., Cambillau, C., 2000. Revisiting the catalytic CuZ cluster of nitrous oxide (N<sub>2</sub>O) reductase. *Journal of Biological Chemistry* 275, 41133–41136.
- Conant, R. T., Berdanier, A. B., & Grace, P. R. (2013). Patterns and trends in nitrogen use and nitrogen recovery efficiency in world agriculture. *Global Biogeochemical Cycles*, *27*(2), 558-566.
- Eschbach, M., Schreier, K., Trunk, K., Buer, J., Jahn, D., Schobert, M. (2004). Long-term anaerobic survival of the opportunistic pathogen *Pseudomonas aeruginosa* via pyruvate fermentation. *Journal of bacteriology*, *184*(14), 4596-4604. DOI: 10.1128/JB.186.14.4596-4604.2004
- Feeney, L., & Berman, E. R. (1976). Oxygen toxicity: membrane damage by free radicals. *Investigative Ophthalmology & Visual Science*, *15*(10), 789-792.
- Fuqua, W. C., Winans, S. C., & Greenberg, E. P. (1994). Quorum sensing in bacteria: the LuxR-LuxI family of cell density-responsive transcriptional regulators. *Journal of bacteriology*, *176*(2), 269–275. doi:10.1128/jb.176.2.269-275.1994
- Green, S. K, Schroth, M. N., Cho, J. J., Kominos, S. D., Vitanza-jack, V. B. (1974). Agricultural plants and soil as a reservoir for *Pseudomonas aeruginosa*. *Applied microbiol.* 28(6), 987-991.

Gupta, R. S. (2000). The phylogeny of proteobacteria: relationships to other eubacterial phyla and eukaryotes, *FEMS Microbiology Reviews*, 24(4), 367–402, <https://doi.org/10.1111/j.1574-6976.2000.tb00547.x>

Härtig, E., Schiek, U., Vollack, K., Zumft, W. G. (1999). Nitrate and Nitrite Control of Respiratory Nitrate Reduction in Denitrifying *Pseudomonas stutzeri* by a Two-Component Regulatory System Homologous to NarXL of *Escherichia coli*. *Journal of Bacteriology*, 181 (12), p3658-3665.

Heffer, P., & Prud'homme, M. (2014). Fertilizer Outlook 2014-2018. Paris, France: International Fertilizer Industry Association (IFA).

Herridge, D. F., Peoples, M. B., & Boddey, R. M. (2008). Global inputs of biological nitrogen fixation in agricultural systems. *Plant and soil*, 311(1-2), 1-18.

IPCC. (2014). Climate Change 2014: Synthesis Report. Contribution of Working Groups I, II and III to the Fifth Assessment Report of the Intergovernmental Panel on Climate Change. Core Writing Team, R.K. Pachauri and L.A. Meyer (eds.). IPCC, Geneva, Switzerland, 151 pp.

Jones, B. W., Nishiguchi, M. K., (2004). Counterillumination in the Hawaiian bobtail squid, *Euprymna scolopes* Berry (Mollusca: Cephalopoda). *Marine biology*, 144(6), 1151-1155. DOI 10.1007/s00227-003-1285-3

Juan, C., Peña, C., Oliver, A. (2017). Host and Pathogen Biomarkers for Severe *Pseudomonas aeruginosa* Infections, *The Journal of Infectious Diseases*, Volume 215, Issue suppl\_1, 15, Pages S44–S51, <https://doi.org/10.1093/infdis/jiw299>

Klockgether, J., Cramer, N., Wiehlmann, L., Davenport, C. F., Tümmler, B. (2011). *Pseudomonas aeruginosa* genomic structure and diversity. *Front. Microbiol.*, 2, 150. <https://doi.org/10.3389/fmicb.2011.00150>

Kraft B., Strous M., Tegetmeyer H. E., 2011. Microbial nitrate respiration – Genes, enzymes and environmental distribution. *Journal of Biotechnology* 155 (2011) 104-117.

LaBauve, A. E., & Wargo, M. J. (2012). Growth and laboratory maintenance of *Pseudomonas aeruginosa*. *Current protocols in microbiology*, Chapter 6, Unit–6E.1.. doi:10.1002/9780471729259.mc06e01s25

LaBauve, A. E., & Wargo, M. J. (2012). Growth and laboratory maintenance of *Pseudomonas aeruginosa*. *Current protocols in microbiology*, Chapter 6, Unit–6E.1. doi:10.1002/9780471729259.mc06e01s25

LaSarre, B., & Federle, M. J. (2013). Exploiting quorum sensing to confuse bacterial pathogens. *Microbiology and molecular biology reviews: MMBR*, 77(1), 73–111. doi:10.1128/MMBR.00046-12

Lee, J. & Zhang, L. The hierarchy quorum sensing network in *Pseudomonas aeruginosa* (2015). *Protein Cell*, 6(1): 26-41. <https://doi.org/10.1007/s13238-014-0100-x>

Lindtveit, K. (2016). *Quorum sensing circuits in Pseudomonas aeruginosa regulate N<sub>2</sub>O reduction* (Master's thesis, Norwegian University of Life Sciences, Ås).

Liu et al., 2014. Impaired reduction of N<sub>2</sub>O to N<sub>2</sub> in acid soils is due to a posttranscriptional interference with the expression of *nosZ*. *mBio* 5(3):e01383-14. Doi:10.1128/mBio.01383-14.

Lupp, C., Urbanowski, M., Greenberg, E. P., Ruby, E. G. (2003). The *Vibrio fischeri* quorum-sensing systems *ain* and *lux* sequentially induce luminescence gene expression and are important for persistence in the squid host. *Molecular Microbiology*, 50, 319–331.

Molstad, L., Dörsch, P., & Bakken, L. R. (2007). Robotized incubation system for monitoring gases (O<sub>2</sub>, NO, N<sub>2</sub>O, N<sub>2</sub>) in denitrifying cultures. *Journal of microbiological methods*, 71(3), 202-211.

Moreno-Vivián, C., Cabello, P., Martínez-Luque, M., Blasco, R., & Castillo, F. (1999). Prokaryotic nitrate reduction: molecular properties and functional distinction among bacterial nitrate reductases. *Journal of bacteriology*, 181(21), 6573-6584.

Nitrogen group, NMBU (2019). Spreadsheets for gas kinetics. Retrieved from:

<https://www.nmbu.no/en/research/groups/nitrogen/spreadsheets->

Papenfort, K., & Bassler, B. L. (2016). Quorum sensing signal-response systems in Gram-negative bacteria. *Nature reviews. Microbiology*, 14(9), 576–588. doi:10.1038/nrmicro.2016.89

Pesci, E. C., Pearson, J. P., Seed, P. C., Iglewski, B. H. (1997). Regulation of *las* and *rhl* quorum sensing in *Pseudomonas aeruginosa*. *Journal of bacteriology*, 179 (10), 3127-3132.

Philippot, L., Hallin, S., & Schloter, M. (2007). Ecology of denitrifying prokaryotes in agricultural soil. *Advances in agronomy*, 96, 249-305.

Portmann, R. W., Daniel, J. S., & Ravishankara, A. R. (2012). Stratospheric ozone depletion due to nitrous oxide: influences of other gases. *Philosophical transactions of the Royal Society of London. Series B, Biological sciences*, 367(1593), 1256–1264. doi:10.1098/rstb.2011.0377

QIAamp DNA Mini and Blood Mini handbook, 2016, p. 33-35, 55-56. Can be downloaded from:

<https://www.qiagen.com/be/resources/download.aspx?id=62a200d6-faf4-469b-b50f-2b59cf738962&lang=en> (Last checked: 10.12.2019)

QiaGen. RNeasy Mini Handbook (EN) for the RNeasy Mini Kit. Retrieved from:

<https://www.qiagen.com/es/resources/resourcedetail?id=14e7cf6e-521a-4cf7-8cbc-bf9f6fa33e24&lang=en> (Last checked: 15.12.2019)

Quick Reference: iBlot 2 Dry Blotting System by Invitrogen. Pub. No. MAN0009113. Rev. C.0.

Retrieved from [https://assets.thermofisher.com/TFS-Assets/LSG/manuals/iblot2\\_device\\_qrc.pdf](https://assets.thermofisher.com/TFS-Assets/LSG/manuals/iblot2_device_qrc.pdf) (Last checked: 15.12.2019)

Quick reference. Qubit assays. Pub. No. MAN0010876. Rev. A.0.. Can be downloaded from:

[http://tools.thermofisher.com/content/sfs/manuals/qubit\\_3\\_fluorometer\\_man.pdf](http://tools.thermofisher.com/content/sfs/manuals/qubit_3_fluorometer_man.pdf) (Last checked: 10.12.2019)

Rao, S., & Riahi, K. (2006). The role of Non-CO<sub>3</sub> greenhouse gases in climate change mitigation: long-term scenarios for the 21st Century. *The Energy Journal*, 177-200.

Ravishankara, A. R., Daniel, J. S., & Portmann, R. W. (2009). Nitrous oxide (N<sub>2</sub>O): the dominant ozone-depleting substance emitted in the 21st century. *science*, 326(5949), 123-125.

Schwartz, T., Volkmann, H., Kirchen, S., Kohnen, W., Schön-Hölz, K., Jansen, B., Obst, U. (2006). Real-time PCR detection of *Pseudomonas aeruginosa* in clinical and municipal wastewater and genotyping of the ciprofloxacin-resistant isolates, *FEMS Microbiology Ecology*, 57(1), 158–167, <https://doi.org/10.1111/j.1574-6941.2006.00100.x>

Signor, D., Cerri, C. E. P., & Conant, R. (2013). N<sub>2</sub>O emissions due to nitrogen fertilizer applications in two regions of sugarcane cultivation in Brazil. *Environmental Research Letters*, 8(1), 015013.

Sistrom, W. R. (1962). The Kinetics of the Synthesis of Photopigments in Rhodopseudomonas spheroids. *J. Gen. Microbiol.*, 28, 607-616.

Sperandio, V., Torres, A. G., Girón, J. A., & Kaper, J. B. (2001). Quorum sensing is a global regulatory mechanism in enterohemorrhagic *Escherichia coli* O157:H7. *Journal of bacteriology*, 183(17), 5187–5197. doi:10.1128/jb.183.17.5187-5197.2001

Spiro, S., 2007. Regulators of bacterial responses to nitric oxide. *FEMS Microbiology. Reviews* 31, 193–211.

Stover, C. K., Pham, X. Q., Erwin, A. L., Mizoguchi, S. D., Warrener, P., Hickey, M. J., ..., Olson, M. V. (2000). Complete genome sequence of *Pseudomonas aeruginosa* PAO1, an opportunistic pathogen. *Nature* volume 406, 959–964



Tage, M. E., Semmelhack, J. L., Bassler, B. L. (2001). The LuxS-dependent autoinducer AI-2 controls the expression of an ABC transporter that functions in AI-2 uptake in *Salmonella typhimurium*. *Molecular microbiology*, 42(3),777-793. doi:10.1046/j.1365-2958.2001.02669.x

Tavares, P., Pereira, A.S., Moura, J.J.G., Moura, I., 2006. Metalloenzymes of the denitrification pathway. *Journal of Inorganic Biochemistry* 100, 2087–2100.

Toyofuku, M., Nomura, N., Fujii, T., Takaya, N., Maseda, H., Sawada, I., Nakajim, T., Uchiyama, H. (2007). Quorum sensing regulates denitrification in *Pseudomonas aeruginosa* PAO1. *Journal of bacteriology*, 189(13), 4969-4972. doi:10.1128/JB.00289-07

Toyofuku, M., Uchiyama, H., Nomura, N. (2012). Social Behaviours under Anaerobic Conditions in *Pseudomonas aeruginosa*. *International journal of microbiology*. 2012. 405191. 10.1155/2012/405191.

Toyofuku, M., Uchiyama, H., Nomura, N. (2012). Social behaviours under anaerobic conditions in *Pseudomonas aeruginosa*. *International Journal of Microbiology*, vol 2012, article ID 405191, 7 pages. doi:10.1155/2012/405191

Turovskiy, Y., Kashtanov, D., Paskhover, B., & Chikindas, M. L. (2007). Quorum sensing: fact, fiction, and everything in between. *Advances in applied microbiology*, 62, 191–234. doi:10.1016/S0065-2164(07)62007-3

Valot B, Guyeux C, Rolland JY, Mazouzi K, Bertrand X, et al. (2015). What It Takes to Be a *Pseudomonas aeruginosa*? The Core Genome of the Opportunistic Pathogen Updated. *PLOS ONE* 10(5): e0126468. <https://doi.org/10.1371/journal.pone.0126468>

Vázquez-Torres, A., & Bäumler, A. J. (2016). Nitrate, nitrite and nitric oxide reductases: from the last universal common ancestor to modern bacterial pathogens. *Current opinion in microbiology*, 29, 1-8.

Wang, M., Schaefer, A. L., Dandekar, A. A., & Greenberg, E. P. (2015). Quorum sensing and policing of *Pseudomonas aeruginosa* social cheaters. *Proceedings of the National Academy of Sciences*, 112(7), 2187-2191.

Winans, S. C., Bassler, B. L. (2002). Mob psychology. *Journal of Bacteriology*, 184, 873–883. doi: 10.1128/jb.184.4.873-883.2002

Yan, T., Fields, M. W., Wu, L., Zu, Y., Tiedje, J. M., & Zhou, J. (2003). Molecular diversity and characterization of nitrite reductase gene fragments (*nirK* and *nirS*) from nitrate-and uranium-contaminated groundwater. *Environmental microbiology*, 5(1), 13-24.

## ADDENDUM

Table A1: Table over primer pair sequences for the quorum sensing genes, which was used in this experiment. The sequences were selected by Linda Liberg Bergaust, researcher at NMBU. F stands for forward primer, and R for reverse primer.

Primer pair (by gene)	Forward / Reverse	Primer sequence (5'→3')	Expected product length (bp):	
			WT	MUT
<i>rhII</i>	F	GTCTTCCCCCTCATGTGTGT	850	400
	R	CCGCAGAGAGACTACGCAAG		
<i>lasI</i>	F	TCTCTCGTGTGAAGCCATTG	999	500
	R	ACCCACAGCATCGATCTACC		

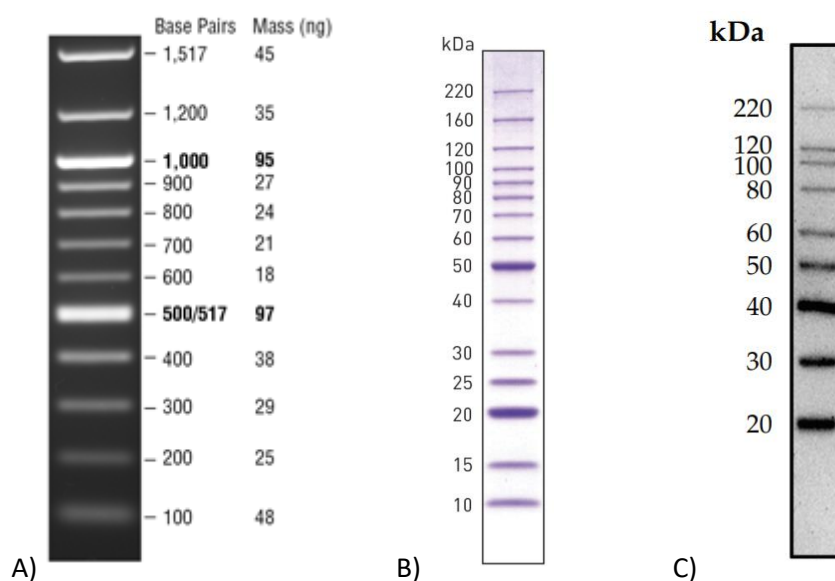

Figure A1. A) is the Quick-Load Purple 100 bp DNA ladder from New England BioLabs Inc.. B) is the Invitrogen™ BenchMark™ Protein Ladder. C) is the Invitrogen™ MagicMark™ XP Western Protein Standard.

Table A2: Table over primer pair sequences for the denitrification genes and *rpoS*, which was used in this experiment. The sequences were selected by Linda Liberg Bergaust, researcher at NMBU.

Primer pair (by gene)	Forward/ Reverse (F/R)	Primer sequence (5'→3')
<i>rpoS</i>	F	GAAGCGGATGATCGAGAGCA
	R	GACGTTGAGCTCCTTGACCA
<i>narG</i>	F	GACGAGAAGATCCGCTTCCG
	R	CTGAGCCAGATGATCGGACC
<i>nirS</i>	F	AGAAAGTCGCCGA ACTACAG
	R	AGGTTCTTCAGGTCGAACAC
<i>norB</i>	F	TACTTCGTGTTCCGCCCTGAT
	R	GTACAGCTCGCAGTCGCTCT
<i>nosZ</i>	F	CGGCAAGTACCTGTT CATCA
	R	GTACAGGGTGAAGGCGTTGT

Table A3: Table of vial sampling times, OD600, strain and student.

Vial	Strain	O <sub>2</sub>	OD600	Day	Time	Student*	Additional notes:
Ino_wt	Wt	oxic	0.110	1	12:30	G	Inoculations of vial 1-30, were done with volumes: 0.850mL of Wt and 1mL of mut, according to strain. Only 20mL were sampled of the inoculum, to due to inoculation volume deficit.
Ino_mut	mut	oxic	0.091	1	12:30	G	
7	Wt	0	0.001	1	15:56	G	Slaughtered vial 3 instead of 18. Vial 18 had no culture growing in it (a dud).  Only extracted 20mL from vial 12. Replaced in slot 3, vial 18, with vial 12 renamed "12.2". Sampling of vial 12.2 effectively replaces that of vial 3, but only 20mL extracted. (same treatment and strain)
8	Wt	2,5	0.002	1		G	
9	Wt	5	0.003	1		G	
22	Wt	0	0.001	1		G	
23	Wt	2,5	0.002	1		G	
24	Wt	5	0.003	1		G	
25	mut	0	0.001	1		16:10	
26	mut	2,5	0.004	1	R		
27	mut	5	0.005	1	R		
28	mut	0	0.001	1	R		
29	mut	2,5	0.005	1	R		
30	mut	5	0.005	1	R		
16	Wt	0	0.008	2	01:14	R	
19	mut	0	0.008	2		R	
17	Wt	2,5	0.137	2	04:02	R	
20	mut	2,5	0.140	2		R	
3	Wt	5	0.250	2	05:15	R	
21	mut	5	0.284	2		R	
10	Wt	0	0.014	2	06:15	R	
13	mut	0	0.018	2		R	
14	mut	2,5	0.183	2	07:40	R	
15	mut	5	0.320	2	09:35	R	
11	Wt	2,5	0.214	2	11:20	R	
5	mut	2,5	0.232	2	14:04	G	
6	mut	5	0.320	2	14:49	G	
2	Wt	2,5	0.243	2	16:26	G	
12	Wt	5	0.311	2	18:43	G	
4	mut	0	0.112	2	20:13	G	
1	Wt	0	0.126	2	23:20	G	
12.2	Wt	5	0.321	3	01:50	G	

\*G and R stands for Glenn and Ricarda respectively.

NOTE: the vials names has been corrected to that of the slot number (3→18, 12.2→3).

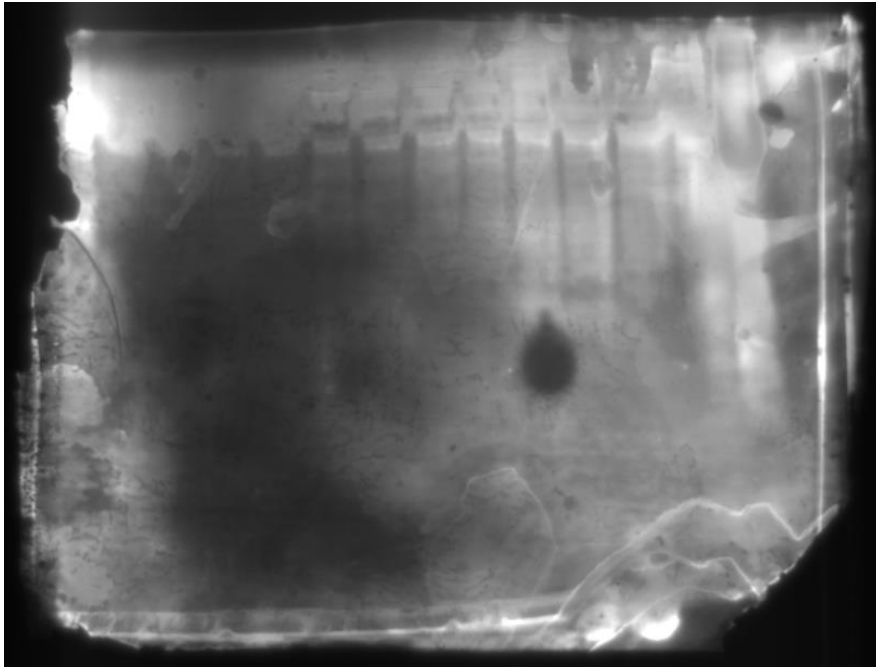

*Figure 2A: Final and failed western blot produced. The huge smear at the right is the positive control. The results are inconclusive. While there are bands aligning with the smear, this could be anything, since the anti-NosZ antibody is not particularly specific. Only a successful western blot could shed some light on what the bands could be.*