



Norges miljø- og
biovitenskapelige
universitet

Master's Thesis 2018 30 ECTS
Faculty of Biosciences
Main supervisor, Rasmus Bovbjerg Jensen

In-vivo and In-sacco method for testing dry matter digestibility of Norwegian cold-blooded horses

X Sumeng

Feed Manufacturing Technology
Faculty of Biosciences

Contents

1	Preface	3
2	Abstract	4
3	Introduction	5
4	Background	7
4.1	Horse gastrointestinal tract	7
4.2	Hindgut fermentation in horses.	8
4.3	Conventional horse feed and their nutrient contents	9
4.3.1	Timothy Hay	10
4.3.2	Sugar beet pulp	11
4.3.3	Lucerne (Alfalfa)	11
4.3.4	Barley	12
4.4	Measurement of digestibility	13
4.4.1	In-vivo total feces collection	13
4.4.2	Marker methods	13
4.4.3	In-sacco method	14
4.4.4	In-vitro method	17
4.5	Digestibility related factors	17
4.5.1	Different feed process affecting digestibility	18
4.5.2	Feed related factors affecting mean retention time	18
4.5.3	Non-dietary factors affecting mean retention time	19
4.5.4	Measurement of mean retention time (MRT)	19
5	Material and Methods	21
5.1	Experimental design	21
5.2	Horses	22
5.3	Preparation of feed samples and mobile bags	23
5.4	In- vivo total feces collection and sample handling	24
5.5	In-sacco mobile bags technique, bags collection and handling	25
5.6	Calculations and statistical analyses	27

6	Results and discussions	28
6.1	Apparent total tract digestibility (ATTD).....	28
6.2	Apparent digestibility of hindgut	30
6.3	Mean retention time (MRT)	31
6.4	Algebraic Digestibility	34
7	Conclusion.....	37
8	Perspectives.....	38
9	Acknowledgement.....	39
10	References.....	40

1 Preface

This master thesis is written as part of larger experiment held in Norwegian university of life sciences (NMBU), in March 2018.

This paper gives a brief description of horse gastric intestine, hindgut fermentation, conventional horse feedstuffs, different digestibility measurement methods as well as factors that affecting feed digestion, especially that of from mean retention time. The paper will focus on evaluating digestibility method —In-sacco mobile bag technique and algebraic In-vivo diet dry matter digestibility calculated by apparent dry matter digestibility of individual feed stuff from In-sacco method based on different mean retention time and different feed ratio.

2 Abstract

Two types of feeds with different fiber sources were investigated in five caecum cannulated Norwegian cold-blooded horses. This objectives of the experiment was to increase fermentable fiber (Sugar beet pulp) into horse diet thereby reduce starch intake of total ratio by partly substituting hay. At the same time, we aimed to evaluate the In-sacco mobile bag technique and apparent dry matter (DM) digestibility of hay and Sugar beet pulp (SBP) by comparing it to In-vivo total feces collection method. In-sacco mobile bag technique examined the apparent hindgut digestibility of hay and SBP in 45 mobile bags respectively and each bag contained 0.5 mg feed samples. In-vivo total feces collection method assessed the DM apparent total tract digestibility (ATTD) of In-vivo diet (Hay +SBP). Two trials were carried out simultaneously and feces were collected in stablemaids (harnesses). Following previous 14 days of adaptation period, feces and mobile bags were collected every 6 hours over four days. In-vivo ATTD of Hay and SBP diet were calculated with observed apparent DM digestibility of each feed stuff based on In-sacco mobile bag technique in various feed ratio and mean retention time (MRT). There were significant apparent DM digestibility differences between SBP and hay and between SBP and In-vivo diet ATTD (Hay +SBP). Apparent DM digestibility of both hay and SBP increased along with bags retention time in hindgut. Calculated value showed that In-vivo diet (Hay + SBP) ATTD of DM increases along with the addition of SBP proportion and increases of MRT.

3 Introduction

Studying horse digestibility is the key way to evaluate and promote equine feed quality and maximize efficiency of feed energy. Related to both extent and rate of feed degradation, accurate estimation of feed degradation pattern along with time decide digestion and absorption in horse digestive tract (Hyslop, 2006).

In-vivo total tract feces collection is still a main way to examine nutrients digestibility (Rodrigues et al., 2012). However, its laborious, time consuming characteristics as well as large amount of feces production stimulate faster and easier alternative methods emerging for digestibility study (Rodrigues et al., 2012). In-sacco method was discovered around 1939 and it was first used to evaluate the rate and extent of degradation in rumen in 1980s (Noziere & Michalet-Doreau, 2000). With horses, the amount of researchers using In-sacco method lag behind ruminant. Compared to total feces collection method, it gives possibility to examine digestibility in each particular segment of digestive tract (Noziere & Michalet-Doreau, 2000). In-sacco methods applied by Hyslop (2006), Rodrigues et al. (2012), Moore-Colyer et al. (2002) and Hymøller et al. (2012) were made references for present study.

Starch rich diet is commonly fed to athletic horses to achieve high requirement of energy (Jullian et al., 2006). However, horse is evolved as high fiber low starch diet herbivores since fiber-based diet maintain normal fermentation conditions (Brøkner et al., 2012a; Hymøller et al., 2012; Jensen et al., 2014). Exceeded amount of starch may cause gastric diseases due to limited ability of starch digestion in foregut, such as colic and laminitis (Jensen et al., 2014; Meyer et al., 1995; Rowe et al., 1994). Therefore, alternative feed that provide sufficient amount of energy and maintain stable, healthy gastric microorganism environment are critical. SBP has been suggested energy source for performance horse as it contain high amount of highly fermentable fiber (Jensen et al., 2016; Moore-Colyer et al., 2002). Furthermore, Murray et al. (2008) found that it has positive effect on apparent digestibility of different nutrients when Lucerne hay partly substituted by SBP.

There are many factors interfering digestibility of feedstuffs. MRT is one of the important factors that affecting digestibility significantly. It has been approved by several studies that

increasing MRT of feed stuff can improve nutrients apparent digestibility(Moore-Colyer et al., 2002; Pearson et al., 2006).

We hypothesized that substitution of insoluble fiber (timothy) with soluble fiber (SBP) and increase feed MRT in gastric intestinal tract in horses would amplify fermentation in hindgut and subsequently increase feed digestibility. The objectives of this experiment were to:

Evaluate if the In-sacco method can be used to predict the in-vivo ATTD in horses.

Examine how the MRT affect In-sacco DM digestibility of hay and SBP.

Evaluate if the ATTD can be predicted based on In-sacco measurements.

4 Background

4.1 Horse gastrointestinal tract

The digestive system of horse is often divided into foregut and hindgut(McDonald, 2002). The foregut consists of mouth, esophagus, stomach and small intestine, while hindgut include caecum, colon and rectum (Figure 1). Feed digestion start from the mouth; the round motion molar and chewing could grind the feed and mix it with saliva (Hymøller et al., 2012). Saliva has buffering function and provide salivary amylase(McDonald, 2002).Efficient chewing of the feed is important for horse gastric intestinal to digest either in pre-caecal or hindgut (Hymøller et al., 2012). This is due to reduced particle size of feed expose large contact surface to enzymes, and it also can be utilized by microflora easily (Hymøller et al., 2012).

Ingested feed pass through esophagus to reach the stomach, in which the enzymatic digestion takes place. The stomach secretes hydrochloric acid (HCl) and pepsin to breakdown feed when it enters the stomach. Digesta further flows to small intestine, where most of the major nutrients, protein, some carbohydrates and fat are digested. However, horse has limited digesta remaining time in stomach (2-6h)(Van Weyenberg et al., 2006) and relatively lower capacity for enzymatic hydrolysis of starch in small intestine compared to other monogastric animals (Hymøller et al., 2012). Therefore, it has been suggested that upper limit starch intake per meal is 1g (Luthersson et al., 2009b) to 2g per kg of body weight(Meyer et al., 1995). It is also noticeable that horses do not have gall bladder, therefore lipid metabolism is also limited in horse digestive tract(McDonald, 2002).

Horses are known as hind gut fermenters The hindgut accounts for approximately 66% of the total volume of the gastrointestinal tract(Lewis, 1995). It contains cecum, large colon, small colon and rectum (Figure 1).

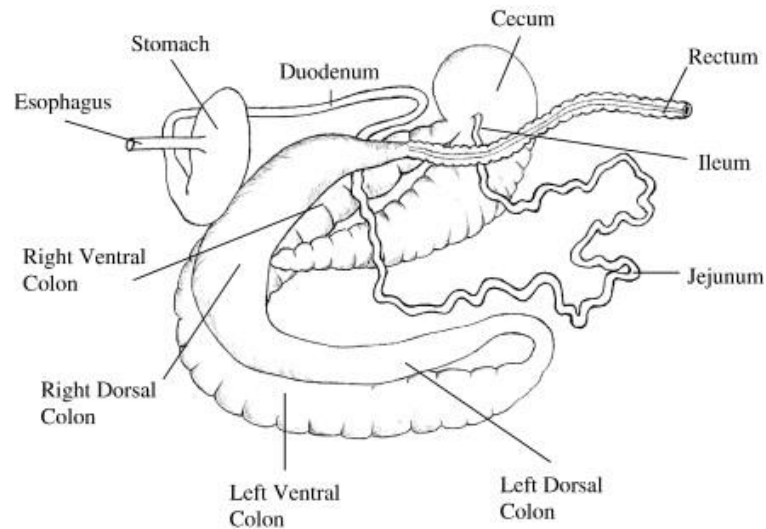

Figure 1
Horse gastric intestine tract anatomy(Van Weyenberg et al., 2006)

4.2 Hindgut fermentation in horses.

Carbohydrate is basic energy source of horses which is broadly divided in two groups; hydrolyzed carbohydrates like starch and sugar and carbohydrate fermented in hindgut like fiber polysaccharides(also known as non-starch polysaccharides NSP) (Brøkner et al., 2012b). As hindgut fermentation animal, horses are well suited in high fiber and low starch diet (Hymøller et al.; Luthersson et al., 2009a). They have highly developed hindgut which houses billions of bacteria and protozoa capable of fermenting large quantities of plant fiber(McDonald, 2002). This microbial fermentation is similar to that occurring in rumen of ruminant such as cows and sheep. Volatile fatty acid(VFA) produced by fermentation in hindgut is the main result of anaerobic microbial fermentation of indigestible carbohydrate such as cellulose, hemicellulose (Bergman, 1990). Acetate, butyrate and propionate acids are main component of VFA and they are utilized by gut microorganism for growth and absorbed by gut for use in metabolic reaction(Bergman, 1990). For instance, acetate is the metabolic precursor of acetyl CoA to produce adenosine triphosphate(ATP)(Hymøller et al.; McDonald, 2002).

High starch concentration is often used in performance horse feed in order to meet the sufficient amount of energy requirements to maximize muscle glycogen stores which consequently fuel anaerobic work (Moore-Colyer et al., 2002). However, as it was mentioned above that escaped from small intestine without being digested, exceeded starch is fermented by microorganisms immediately and produce large amount of VFA which reduces hindgut pH. This change can be detrimental to the maintenance of favorable hindgut environment (Brøkner et al., 2012a). Consequently, it easily causes diseases such as acidosis, colic, laminitis (Brøkner et al., 2012b; Lindberg & Karlsson, 2001; Moore-Colyer et al., 2002; Murray et al., 2008). Therefore, avoiding digestive tract disorder caused by high starch concentrate become a great challenge in performance horse feeding.

Fiber fermentation is slow enough to ensure VFA producing rate suits for hindgut capacity (Hymøller et al., 2012). In order to maintain the health and avoid the abnormal behavior as well as to reach the nutrients requirement, sufficient amount of fiber intake is necessary for horse keeping (Brøkner et al., 2012b). Therefore, desirable alternative concentrate feed should possess high energy and high fiber content (Murray et al., 2008).

4.3 Conventional horse feed and their nutrient contents

Replace the use of starch with fibrous feed in performance horse is critical in feed industry since fibrous feed can potentially increase energy status and keep healthy gut environment. The main carbohydrate energy source in horse feed is fiber which is rich in plant cell walls. Fiber composition is different in various feed stuff. There are several different methods for measuring fiber content. Brøkner et al. (2012b) compared three different methods to evaluate fiber content which are crude fiber, neutral detergent fiber and dietary fiber methods.

Dietary fiber as described by Bach Knudsen (1997) commonly refers to non-starch NSP and

Lignin. Lignin as another major component in plant cell wall, which is not carbohydrate but highly associated to carbohydrate, has high resistance of chemical degradation (McDonald, 2002). NSP can be further divided to soluble and insoluble NSP. Plant contain mixture of soluble and insoluble NSP according to their type and maturity (Brøkner et al., 2012b). The soluble and insoluble characteristics of NSP were defined from its component: cellulose and non-cellulose polysaccharides (NCP), in which cellulose is insoluble and NCP is further divided into soluble (S-NCP) and insoluble NCP (I-NCP) (Figure 2). Jensen et al. (2014) also used dietary fiber analysis to determine different fiber fraction of barley, SBP and hay and they found that SBP had highest S-NCP among two other analyzed feedstuffs.

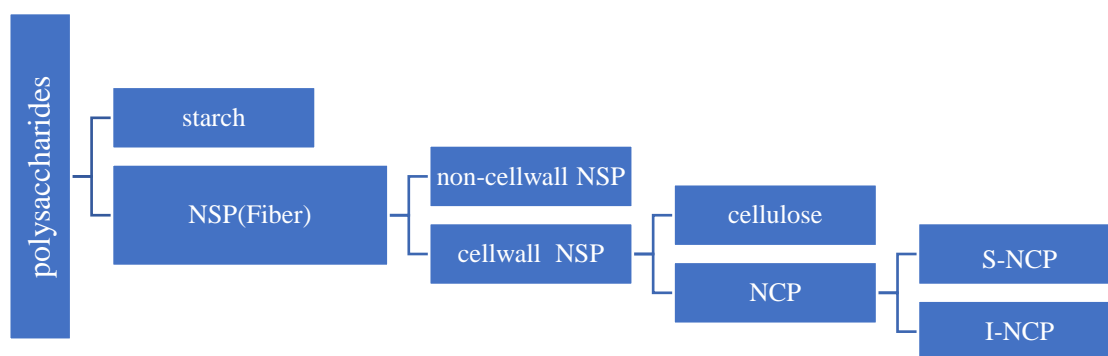

Figure 2

Brief classification of feed polysaccharides. NSP= Non-cellulose polysaccharides; NCP= Non-cellulose polysaccharides; S-NCP= soluble non-cellulose polysaccharides; I-NCP= insoluble non-cellulose polysaccharides

Brøkner et al. (2012b) has been divided 18 typical conventional horse feed stuff into 3 groups in their study, which are forages, root crop and concentrate. Based on Brøkner et al. (2012b) study, timothy and lucerne from forages, SBP and molassed SBP from root crop, barley from concentrate group analyzed by dietary fiber analysis were chosen to describe briefly in below (Table 1).

4.3.1 Timothy Hay

Horses have evolved as grass eaters and timothy hay is the most common diet for Icelandic horses (Müller & Udén, 2007; Ragnarsson & Lindberg, 2008). Due to the cold weather in the northern part of the world, hay-making is the most common form of preservation for horses or other domestic animals (Müller & Udén, 2007). Forage maturity is one of the factors that

influencing digestibility. Along with forage growth, lignin and indigestible fiber content increase due to structure role (McDonald, 2002). In Ragnarsson and Lindberg (2008) study, they tested four different stages of timothy haylage to Icelandic horses and found that the early cut timothy haylage has the nutritional properties required to form the basis of diet for horses.

4.3.2 Sugar beet pulp

Sugar beet is an alternative energy source for equine because of its readily fermentable characteristics, low protein content and good palatability (Bach Knudsen, 1997; Jensen et al., 2016; Lindberg & Karlsson, 2001; Olsman et al., 2004). It is residue of sugar beet; sugar is extracted at certain temperature (70°C) and then the residue was dried to pulp. (Table 1) provided by Brøkner et al. (2012b) shows that although both of timothy and SBP have relatively similar NSP content, degradation level of NSP in SBP was higher than that of in hay cubes (Olsman et al., 2004). This is because SBP has extremely higher content of soluble NCP than timothy, which is highly digestible in horses (Hoffman et al., 2001). One of the reasons that well digestible of soluble fiber is due to its water holding capacity (Bach Knudsen, 2001). Their water absorbing and swelling results in expanding particle surface area that readily available for microorganism to colonize. Study from Moore-Colyer et al. (2002) showed that SBP has significant higher water holding capacity, which is associated with significant higher digestibility, than that of hay cubes, out hulls and soybean hulls.

Comparable study from Jensen et al. (2014) also showed that although hay had highest fiber content, SBP had highest S- NCP content among 3 feed. Pectic substances is primary S-NCP in plant cell walls that are particularly abundant in SBP. In horse feed, both of SBP and MSBP are often used. In some previous studies, the nutrients digestibility increases when SBP partly substituted with basal forage like timothy hay or lucerne hay (Jensen et al., 2016; Murray et al., 2008). However, SBP might delay gastric emptying because of its high viscosity and it might further impact glucose absorption in small intestine.

4.3.3 Lucerne (Alfalfa)

Lucerne is leguminous forage, which is one of the most common horse feed components in UK

(Cuddeford, 1994). It was indicated that the Lucerne has more nutritional value than timothy due to its higher soluble fiber (Table 1). Nadeau et al. (2000) indicated that feeding concentration with lucerne hay increases pH in the gastric secretions, which has buffering effect on reducing gastric ulceration.

4.3.4 Barley

As a grain feed, barley generally contains large amount of starch (Table 1). Therefore, Barley is commonly fed with fibrous feed to horses. Jensen et al. (2016) found that barley-based diet fed to horses has low caecum pH due to by passing starch (undigested in small intestine) reaching caecum. Barley starch are resistant to pre-caecal enzymatic hydrolysis and it is more fermentable in hindgut (Julliand et al., 2006). Furthermore, Brøkner et al. (2012a) showed that the barley diet was sufficient to decrease caecal pH, which negatively affect fiber digestibility.

Table 1

Different chemical composition of four various common horse feed stuff analyzed by enzymatic-colorimetric method(starch), low molecular weight method(sugar), dietary fiber method (Brøkner et al., 2012b)

	Diet				
	Timothy	Lucerne	SBP	MSBP	Barley
Chemical composition					
Total carbohydrate	705	482	769	753	791
Sugar	100	34	56	210	40
Starch	1	7	15	3	575
NSP	600	440	698	540	170
Soluble NCP	12	54	283	257	43
Insoluble NCP	240	150	200	140	100
Dietary fiber	699	592	728	572	192

4.4 Measurement of digestibility

Accurate estimation of feed degradation is important to calculate well balanced and formulated diet rations, optimize work outputs along with feed efficiency and minimize digestive upsets and associated health problem. In order to obtain balanced diet properly, accurate quantification of nutrients that are digested and absorbed in each segment is critical(Hyslop, 2006). There are several different techniques for determining horse feed digestibility and rate and extent of feed degradation such as In-vivo total feces collection, In-vitro method, In-sacco method as well as external and internal marker techniques.

4.4.1 In-vivo total feces collection

The total feces collection is still the widest used method for evaluating horse feed(Rodrigues et al., 2012). In digestive experiment, ingested feed and excreted feces are measured. In order to get the accurate dietary intake, feed refusal should also be measured. Regarding to feces collection, keeping horses in individual stalls and collecting feces immediately after animal defecate is a typical method(Rodrigues et al., 2012). Collecting harness (stable maids), which collects urine and feces separately, is also often used. This tool allows horses move freely during the experiment period.

Although In-vivo digestibility is considered as the most reliable method for evaluating digestibility, it has many limitations such as time consuming, labor costing and requirements of large amount of feces collecting as well as large storage (Miraglia et al., 1999; Rodrigues et al., 2012). Therefore, more efficient alternative techniques for feed degradation are required.

4.4.2 Marker methods

Measuring exact feed intake and feces excretion is impractical in some certain circumstances, such as studying digestibility of grazing animals. However, the use of internal and external marker overcomes exact feed intake measurement and total feces collection(McDonald, 2002).

Markers should fulfill the requirements that are non-toxic, unaltered, nearly indigestible throughout the gut and totally recovered in feces(Sales & Janssens, 2003).

Internal marker is a natural component of feed such as lignin, acid ingestible ash and acid indigestible fiber(McDonald, 2002). However, when using internal marker such as lignin there are some practical problems. For instance, horses eat selectively when grazing; they prefer leaves more than stem and prefer fresh more than old, which lead to difficulties in take representative samples from pasture(McDonald, 2002). Long-chain hydrocarbons (*n*-alkanes, C25–C35), which is found recently in the cuticular wax of plants and it used by Ordakowski et al. (2001). Advantages for using alkanes is that it is cheap and easier to analyze compare to acid indigestible ash.

External marker is chemical indigestible component that adding into feed for mostly calculating feces output (McDonald, 2002). Same amount of external marker is fed to animals for 10 to 15 days then calculate feces output based on the marker content that excreted in feces. Chromic oxide (Cr_2O_3), is the most extensively used marker (Miraglia et al., 1999). Ytterbium is also widely used.

4.4.3 In-sacco method

The In-sacco method is commonly used for estimating nutrient degradation in rumen digestion (Noziere & Michalet-Doreau, 2000). Although this technique is quite old, according to horse nutrition study, the amount of data that available for equine feed degradation by In-sacco technique is significantly less than that of ruminant (Hyslop, 2006; Noziere & Michalet-Doreau, 2000). In-sacco method is a direct method of calculating digestibility by measuring disappearance of defined feed stuff from undegradable porous bag(polyester, nylon or dacron) (Huntingdon & Givens, 1995). The main principle of this methodology is that the rumen(or caecum)microorganism move freely through those bags and colonize, ferment the feed stuff in bags (Noziere & Michalet-Doreau, 2000).This methodology makes it possible to assess the digestibility in each of the major segments of digestive tract(Hyslop, 2006; Noziere & Michalet-

Doreau, 2000). Feedstuffs that filled in bags are often ground to imitate mastication effect (Noziere & Michalet-Doreau, 2000). This is because mastication decreases particle size to expose more surface area to microorganism utilization as well as provide possibilities to release soluble nutrients, which potentially affects digestibility observation (Hymøller et al., 2012; Noziere & Michalet-Doreau, 2000).

With different pore sizes wide range of bags sizes have been used in former studies. Rodrigues et al. (2012), who used 6.5× 3.0 cm bags size with 45µm pore size observed MRT was 52.2h and ATTD of DM of coastcross hay was 53.23%. Moore-Colyer et al. (2002) applied 6×10cm bag size and 41 µm pore size, the MRT of bags ranged from 55-65h. Brøkner et al. (2012a) used 11µm pore size and Hyslop (2006) used the bags with 6.5×20cm. In present study, 37µm size pore was applied regarding to the suggestion of Norfor (*NorFor in sacco standard*, 2007). In addition to different bag sizes, different types of incubating technique are also used in various studies. Such as naso-gastric incubation and caecum incubation.

Bags can be inserted from nose via naso-gastric tube to test pre-caecal digestion or total tract digestion, of which bags are captured in caecum or found in feces (Hymøller et al., 2012; Moore-Colyer et al., 2002). While examining hindgut feed stuff degradation, inserting the bags into caecum directly for caecum cannulated horse (Rodrigues et al., 2012). Those caecum incubated bags can be captured in different ways due to various objectives. Bags are incubated into caecum by means of binding with long tube as it suspended in rumen (Figure 3). In this case, the retention time of bags in caecum is easily controlled (Hyslop, 2006). (Figure 4) from Hyslop (2006) illustrated four different feedstuffs degradation profile by using In-sacco (In situ) method. However, in rumen incubating test, it had been indicated that different location of bags that binding on the tube from one end to another may cause various disappearance of nutrients (Noziere & Michalet-Doreau, 2000). From previous experiments, we found that this long tube may also cause discomfort since horse caecum is smaller than the rumen in ruminant.

Another commonly used technique is inserting bags individually through canula to the

caecum(Rodrigues et al., 2012). Those bags move along with the gut constructions like any other normal digesta. Bags are consequently found in feces and collected. Another summary of total tract certain feed stuff degradation profile is illustrated in (Figure 5) (Hyslop, 2006). This method closely restore true digestive movement and avoid discomfort for the horses(Moore-Colyer et al., 2002). However, due to big particle size of the bags, its passage rate tends to decrease, which lead to uncontrolled various retention time.

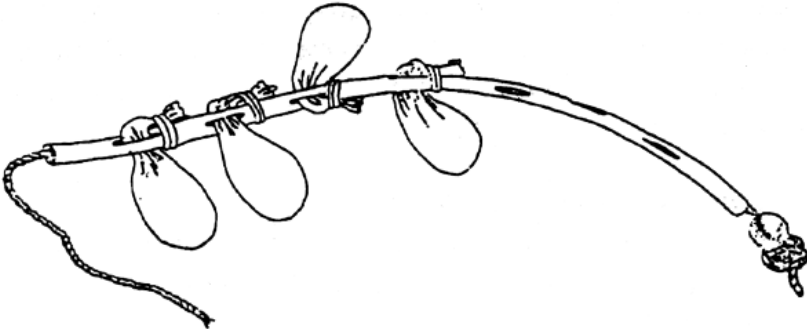

Figure 3
Illustration of plastic tube and attachments of undegradable bags for suspension in the rumen.

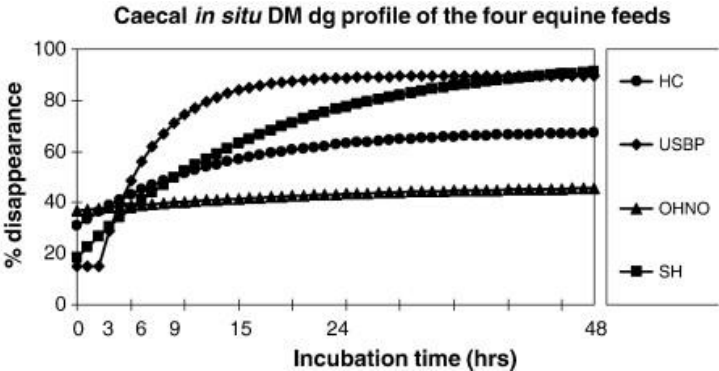

Figure 4
In situ degradation profiles of unmolassed sugar beet pulp (USBP), hay cubes (HC), soya hulls (SH) and a 2:1 mix of oat hulls/naked oats (OHNO) following incubation in the equine caecum(Hyslop, 2006).

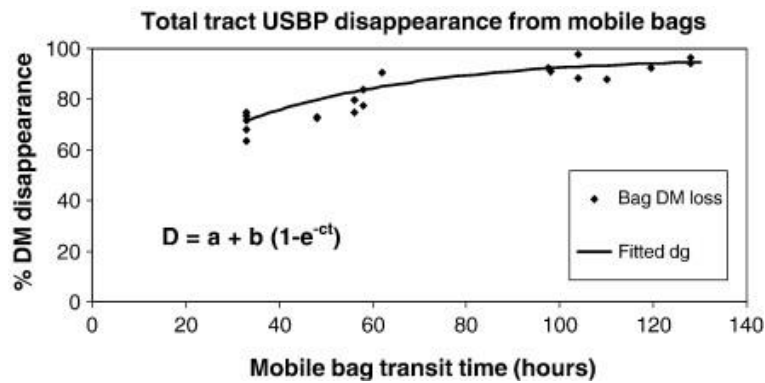

Figure 5

Degradation profile fitted to dry matter(DM) disappearance of unmolassed sugar beet pulp (USBP) from mobile bags recovered from horse feces(Hyslop, 2006).

4.4.4 In-vitro method

The main idea of in-vitro method that assesses forage nutritive value and digestibility is through measuring rate and extent of gas emission from feedstuffs fermentation(Lowman et al., 1999). Microorganism inoculum from rumen digesta is widely used in In-vitro method, which is necessary to be collected from fistulated cows(Earing et al., 2010).However, the practice of this technique has been limited for horses as caecum cannulated horses are not widely available. Those gut microorganisms can also be found in feces since they are defecated in large amount with digesta residues and they can be viable for several hours(Lowman et al., 1999). Compared to ruminant, horse, as a hindgut fermenter, is more suitable for this method due to their no or little post fermentative microorganism activities, which could be a disadvantage in the case of ruminant.(Lowman et al., 1999) Moreover, microorganisms from feces are cheap, easy to be collected (no special need of animals to be fistulated) and can be collected from numbers of animals thereby diminish experimental random errors from individual differences(Earing et al., 2010; Lowman et al., 1999).

4.5 Digestibility related factors

There are several factors that affect feed digestibility of horses. In addition to horse individual

differences, botanical origin is also important factor that affects digestibility. As carbohydrate listed in (Table 1) when feed ingredient rich in soluble fiber digestibility is higher(Hoffman et al., 2001). Furthermore, different processing way is also affecting feed digestibility. Processed(mechanical and thermal) grain feed increases starch digestibility in foregut (Julliand et al., 2006). It has been indicated that MRT is the most important factor that can maximize digestibility of a particular feed stuff with longer retention times associated with higher digestibility (Van Weyenberg et al., 2006).

4.5.1 Different feed process affecting digestibility

Processing is the main factor that affect pre-caecal feed digestibility(Julliand et al., 2006). Feed can be processed in different ways, and the common processing in horse diet are pelleting micronizing and extruding(McLean et al., 2000). In the case of grain feed, nutrition content especially starch processed through mechanical and thermal treatments to reach highly digestible in horse small intestine. Starch gelatinization would occur in these processes, in which complex long chain starch carbohydrate are easily digested in small intestine. However, present study was mainly focus on hindgut digestibility, therefore foregut digestion will not be discussed in detail in this paper. Julliand et al. (2006) did not find any effect of either mechanical or thermal treatment on amount of starch that reaches hindgut. However, McLean et al. (2000) observed different fermentation degree between micronized or extruded(higher fermentation) and rolled(lower fermentation) barley starch.

4.5.2 Feed related factors affecting mean retention time

One factor that affect feed degradation is the length of time feed retained in the gastric intestinal tract. According to marker method, MRT is defined as the integrated average time between the marker ingested and excreted (Van Weyenberg et al., 2006). In some previous studies, wide range of total tract MRT(21.3h to 38h) has been reported based on various of diets, feces collecting methods and testing methods for horses and ponies (Austbø & Volden, 2006; Jensen et al., 2014; Miyaji et al., 2008; Murray et al., 2009; Pearson et al., 2001; Pearson et al., 2006). Various types of diet, levels of feed intake as well as exercise intensity have impact on retention time and indirect influence on digestibility.

Jensen et al. (2014) and Pearson et al. (2001) indicated that increasing feed intake is associated to decreasing MRT due to rarely empty stomach of horse. When feed intake stops, the digesta flow from stomach into duodenum will stop (Van Weyenberg et al., 2006). Comparative studies of different feeding levels (10.7gDM/kg BW and 18.1g DM/kg BW) of high-energy haylage-only diet fed 8 Icelandic horses had shown that the apparent digestibility of DM, organic matter, neutral detergent fiber were higher in horses fed with the lower feeding level than the high feeding level (Ragnarsson & Lindberg, 2010). Among them, the most significant difference was observed in neutral detergent fiber and this result corresponded to the observation of Miyaji et al. (2011) and Moore-Colyer et al. (2003) , which showed increasing concentration of fiber in diet negatively influence MRT.

Different types of diets and diet ratio can be other factors that influence digestibility. Partly replacing basal forage with SBP increases feed digestibility(Murray et al., 2008).

4.5.3 Non-dietary factors affecting mean retention time

Animal body weight has positive relationship with MRT (Van Weyenberg et al., 2006). In Miraglia et al. (1992) study, they found that high weight dry mare has significant higher MRT than light weight geldings regardless of feed intake level. However, Van Weyenberg et al. (2006) did not find any relationship between body size and MRT in their study.

Generally ,exercise is known as having an opposite effect on horse digestibility due to the influence of faster gut construction on passage rate, which cause limited enzymatic digestion and microbial fermentation (Van Weyenberg et al., 2006). However, it has been reported that exercise resulted in a shorter MRT for particle phase marker, while longer MRT for fluid phase marker. Moreover, gestation and lactation can be other factors that influence MRT (Van Weyenberg et al., 2006).

4.5.4 Measurement of mean retention time (MRT)

External marker method has been widely used for MRT measurement. Indigestible markers are dosed and fed to horses. In sampling point, defecated with feces, those markers are analyzed for concentration. In the recent study, Jensen et al. (2014) had used Ytterbium as an external marker to measure total MRT in horses. Moore-Colyer et al. (2003) claimed that Ytterbium is a successful external marker for determining total tract MRT of fiber-based diet in horses. (Table 2) listed two different previous studies that tested total tract MRT by marker method. One comparable research from Austbø and Volden (2006) went under similar feeding level with 7kg/day of hay and 3kg/day of concentrate, same experimental horses, and 60~90 min of exercising time with present study. Another comparable study from Jensen et al. (2014) had same experimental horses and similar diet composition and ratio, of which 85% of the feed was hay and 15% was SBP found 21.9h total tract MRT, results therefore from these two comparable studies were used for later discussion.

Table 2

Total tract mean retention time (MRT) and dry matter (DM) digestibility from two previous studies that used marker method

	Animals	DM Intake(kg/day)	Exercise	TMRT(h)	DM digestibility (%)
<i>Jensen et al. (2014)</i>	4 Norwegian coldblooded trotter horses	7.95kg Hay 1.41(15%)kg MSBP*	6h free move, different exercising method throughout the experiment	21.9	61.5
<i>Austbø and Volden (2006)</i>	4 Norwegian coldblooded trotter horses	7kg Hay 3kg concentrate	60-90min Free move	26.9	—

5 Material and Methods

5.1 Experimental design

The experiment was carried out in Ås gård (Norwegian university of life sciences). Two different digestibility trials: In-vivo total feces collection and In-sacco mobile bag technique were conducted simultaneously to measure ATTD and apparent hindgut digestibility of 5 mature horses (Table 3). The whole period consisted of 14 days adaptation followed by consecutive 4 days of feces collection. Horses were equally offered 7.5kg (6.806kg DM) hay which was given in 3 times per day and 0.5kg (0.45kg DM) of SBP, which was given in two equal meals in 8:00 and 20:00 (Table 4). SBP was soaked for 6h in 4.6L water prior to the feeding in order to avoid esophageal obstruction (Olsman et al., 2004). Drinking water was continuously available from automatic water troughs.

Table 3
Simultaneously conducted In-vivo and In-sacco method information

Feed	In-vivo	In-sacco	
	Hay + SBP	Hay	SBP
Feeding method	Directly fed to horses	Filled in polyester bags and inserted in caecum	
Feed amount	7.5kg/day + 0.5kg/day	0.5g/bag	0.5g/bag
Bags amount	—	45	45
Feeding/inserting frequency	3 times a day(Hay) + 2 times a day(SBP)	3 times in the first day	
Digestibility measurement	Total feces collection	Feed residues in bags	

Table 4

Horses feeding time table

	Morning 8:00	Midday 14:00	Evening 20:00
Hay(kg)	2.5	2.5	2.5
Sugar beet pulp(kg)	0.25	0	0.25

5.2 Horses

Five Norwegian coldblooded trotter horse geldings were used in the experiment (Lykkevar, Lyn, Lars, Prinsen, Tyin; aged 11 to 26 years; initial body weight is 509–597 kg). The horses were fitted with a permanent canula closed by a rubber plug at the base of caecum. A long tube connected to canula reaches caecum, and undegradable In-sacco mobile bags were inserted through this tube. Horses were maintained in unheated pens with individual stalls that fitted with wooden soft shavings flakes for bedding.

Horses were allowed access to free outside exercise for 2 hours a day after daily feces measurements. This exercise encourage horses to move freely which may assist in normal movement of stomach contents through the gastric intestinal tract as well as to satisfy their need for social interaction through free moving on dirt paddock in a group of five (Brøkner et al., 2012a). Prior to experiment, horses were sent to veterinarian for health inspection. All horses remained healthy throughout the study, and they were cared according to Norwegian live animal experiment laws and regulations. Horses were fitted with stable maids (Melbourne, Australia) in the beginning of feces collection. Feces and urine were collected separately in these stable maids (Picture 1).



Picture 1

Stable maid fitted on horse

5.3 Preparation of feed samples and mobile bags

The feeds that were placed into the polyester bags were hay and SBP. Feedstuffs were ground with a cutting mill to 1.5mm (Cutting Mill SM 200 from *Retsch*). 37 μ m pore size porous undegraded polyester material (*NorFor in sacco standard*, 2007) was used for 1.5cm \times 15cm bags. This bag size were designed according to former experiment from Brøkner et al. (2012a). Rectangle shaped cloth were cut slightly bigger than the size to leave room for heat sealing (heat sealing machine from VWR: Part of Avantor). Turn over inside out after sealing to make sure the rough edges were inside of the bags (Brøkner et al., 2012a). More than 120 mobile bags were made including 30 bags of comparison trial in addition to the required 90 bags of In-sacco trial. Several extra bags were made in case of unexpected damages during the handling of bags. Prepared bags were permanently marked with numbers. Those bags from number 1-45 were filled with approximately 0.5g of SBP (ground in 1.5mm) and bags from number 46-90 were filled with approximately 0.5g of hay (ground in 1.5mm) respectively (Picture 2). At the same time, Heat sealing machine was used to seal the opening properly after the completion of

fill up.



Picture 2

In-sacco bags filled with feed sample and marked with permanent mark

5.4 In- vivo total feces collection and sample handling

Feces collection started 6h after the first meal was offered, and the collection had been done 4 times every 24h until the morning of day 5. Total collecting period was 4 days (Table 5). Collected feces were stored in individual plastic buckets for each horse and kept in refrigerator in 4 °C (Picture 3). After completion of each day's feces collection. After completion of each day's feces collection, total feces from each horse were weighed and two metal boxes of samples were taken for dry matter output calculation, which were oven dried in 102°C for 24h. Replications of two boxes were aimed to get more reliable results. Collected feces were totally mixed before taking samples in order to get the most representative samples.



Picture 3
Total feces collection from stable maid

Table 5
Feeding, total feces collecting and weighing plan

	07:00	08:00	13:00	14:00	19:00	20:00	24:00
Day1	Feeding, bags incubating	—	Feces collecting	Feeding, bags incubating	Feces collecting	Feeding, bags incubating	Feces collecting
Day2- 4	Feces collecting,	Feeding Weighing total feces of the former 24h	Feces collecting	Feeding	Feces collecting	Feeding	Feces collecting
Day5	Feces collecting	Weighing total feces of the former 24h					

5.5 In-sacco mobile bags technique, bags collection and handling

In the first day of experiment, up to 3 porous In-sacco bags containing each feed sample respectively (3 for SBP, 3 for hay) are suspended in ceacum (Picture 4) of each horse in 3 times. They were folded in V-shape and poked it with plastic long tube to confirm they were reaching the caecum. Bags were recovered and manually picked up (Picture 5) from the feces during the collection period. The finding time of the bags were noted and then, the bags were gently

washed in cold tap water and stored in freezer in -18°C for later analysis. The main purpose of the washing was to stop microorganism activity(Noziere & Michalet-Doreau, 2000) The bags recovered outside of the collecting period were discarded since they are not representative of the digestive process.

At the end of the experiment, those bags were thawed and washed in washing machine (Bosch avantixx 7) for 35min under the wool washing mode without spinning dry. Squeeze bags gently and dried them into 45 °C oven for 48 hours. Consequently , the bags were weighed to measure dry matter disappearance.

Ten bags of each feed (hay and SBP) were tested to determine the particle loss through the bag pores. Those bags filled with 0.5g of each feed were weighed, sealed, washed and dried. The final dried materials were weighed in a same way with that of examined samples.



Picture 4
Incubation of In-sacco bags through caecum canula



Picture 5
Manually pick up In-sacco bags from feces

5.6 Calculations and statistical analyses

ATTD coefficient with total feces collection were measured according to the formula proposed by (Schneider & Flatt, 1975). In In-vivo method, ATTD of dry matter was calculated from weight loss of feces based on the amount of feed ingested. In In-sacco mobile bag technique, weight loss of bags was expressed by dry matter ATTD which is determined by the residues of samples (Moore-Colyer et al., 2003). The formula proposed by Moore-Colyer et al. (2002) presented below:

$$\text{digestibility coefficient(\%)} = \frac{I - F}{I} \times 100\%$$

I is the amount of feed (g) inserted in each bag, and F is the residue of the feed (g) after recovery of the bags in the feces.

Mean retention time is calculated with the formula:

$$\text{MRT(hours)} = \frac{\sum m_i \times t_i}{\sum m_i}$$

This formula was reported by Blaxter et al. (1956) for the first time, which was based on marker content. Where m_i = the amount of marker at the i th sample and t_i = the middle of the i th sampling intervals. Rodrigues et al. (2012) used this formula to present MRT based on mobile bags method in his digestibility study in which m_i = number of bags recovered in feces in i intervals, t_i = time interval between the insertion of the gastric bags in i collection time in the feces.

Results were analyzed statistically, and the difference were considered as significant when $p < 0.05$. R studio (R3.3.2) was used for analyses. Each variance was conducted by Analysis of variance (ANOVA). All data presented as: mean \pm SD (standard deviation)

6 Results and discussions

During the trial, the general health of the horses was good. They had good appetite throughout the trial. There were no feed refusals, no signs of irritation for the placement of mobile bags in the caecal cannula and no discomfort in daily exercise. The addition of SBP to the hay resulted in increasing DM digestibility of experimental diet, which is consistent with the observation of Murray et al. (2008).

6.1 Apparent total tract digestibility (ATTD)

There were no significant DM digestibility differences among five horses throughout the trails ($p=0.546$). Tyin had lowest ATTD compared to others. This is because he had been fed same amount of feed with others, but he has the lightest body weight

Table 6). This result conforms to the observation of Pearson et al. (2001), Jensen et al. (2014) and Ragnarsson and Lindberg (2010) that larger feed intake reduces the MRT and consequently reduces DM digestibility.

Table 6

DM intake (kg/day, apparent total tract digestibility (ATTD \pm SD) of 4 days

	SBP(intake)	hay(intake)	ATTD
Lykkevar	0.45	6.806	58.98 \pm 4.3
Lyn	0.45	6.806	58.53 \pm 0.8
Lars	0.45	6.806	60.33 \pm 3.8
Prinsen	0.45	6.806	60.31 \pm 1.4
Tyin	0.45	6.806	57.59 \pm 0.4

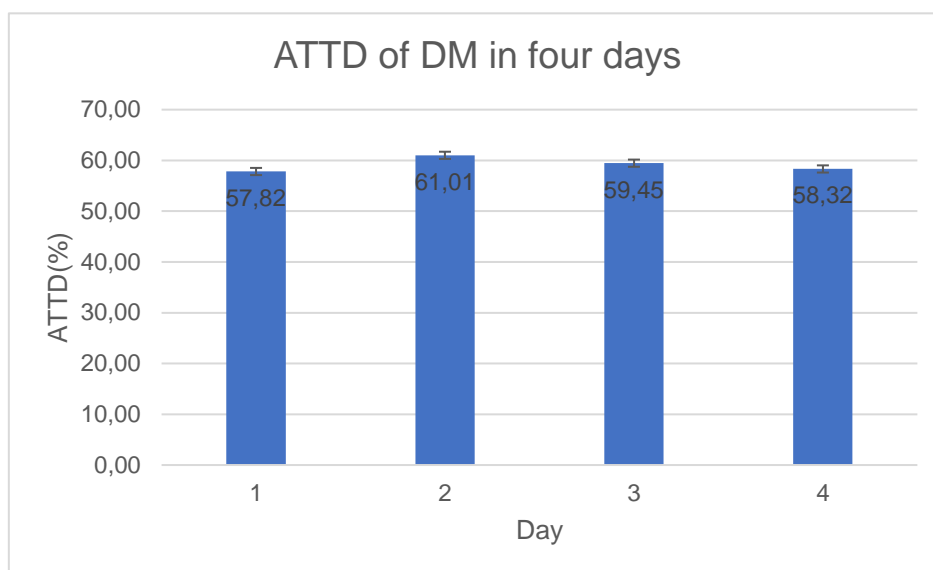

Figure 6

Four days In-vivo dry matter (DM) apparent total tract digestibility (ATTD) of five horses

There were no significant differences of ATTD of DM among each day trial on five horses ($p=0.991$) (Figure 6). By In-vivo method, the average ATTD of DM digestibility of 5 horses was $59.15 \pm 2.59\%$. This value is similar to the ATTD observed by Ragnarsson and Lindberg (2008) (62.6%) who fed hay in different maturity stages to examine nutrients digestibility of horses. Murray et al. (2008) observed 63% of DM digestibility in their study when they substituted lucerne hay with 300g/kg of SBP to horse diet. This slight different DM digestibility is probably because lucerne hay, as a legume forage, has higher nutrition value than the timothy hay.

In the study of Jensen et al. (2014), observed by marker method, ATTD of DM of hay was 56.5% when partly substituted by SBP. Although studied same animals, used same diet with larger amount of SBP, Jensen et al. (2014) observed lower DM digestibility compared to our study. This is probably because of different fiber content from different origin or different maturity of hay. In Jensen et al. (2014) study, the NDF content of hay was 685g/kg whereas, in present study, it was 613g/kg. Another reason could be differences of MRT between two studies, which will be discussed in following text.

6.2 Apparent digestibility of hindgut

DM digestibility of hindgut was conducted by In-sacco method. $89.76 \pm 4.73\%$ and $60.54 \pm 3.89\%$ of DM disappearance for SBP and hay were tested respectively. This is comparable with the study from Moore-Colyer et al. (2002): In studied ponies, disappearance of SBP from bags in total tract was 85% and that of from hay cube bags was 56%. Although those bags from Moore-Colyer et al. (2002) study was traveled through total gastric intestinal tract, those nutrients in our study supposed to be hydrolyzed by pre-cecal enzymes which were assumed to be completely fermented by hindgut microorganisms. Therefore, comparing these two values is reasonable.

There was an effect on apparent digestibility of DM ($p < 0.001$) with SBP having significant higher ATTD digestibility than hay, and it also has higher apparent DM digestibility than that of from in-vivo total feces collecting method (Hay+SBP). This is due to high soluble fiber content in SBP compare to Hay. However, apparent DM digestibility of hay had no significant difference ($p = 0.155$) with dry matter of ATTD (Hay+SBP) (Figure 7). This observation was different from the hypothesis in present study that the dry matter ATTD of fed diet (Hay+SBP) has significant higher value than the apparent DM digestibility from that of Hay only. However, the average apparent DM digestibility (Hay: 60.54 SBP: 89.76) could not be a representative value if take MRT into consideration. Jensen et al. (2014) and Austbø and Volden (2006) observed the MRT in total tract was 21.9h and 26.9h respectively (Table 2). In this case, ATTD of DM is calculated both in 20h and 26h retention time point (Table 8). We found that these two calculated ATTD (55.63 ± 2.09 and 58.55 ± 1.48 for Hay) in reasonable MRT could clearly indicate the state that addition of SBP would increase DM digestibility of diet.

Another potential reason that cause non-significance is may due to insufficient amount of SBP in the diet ratio. In Murray et al. (2008) study, they did not find sequential significant increase with adding SBP into lucerne hay, but it was due to how much extent the SBP had been added. They found that there were no significant DM digestibility increase with most of the nutrients

from 100g/kg SBP to 200g/kg SBP substitution, but 300g/kg SBP substitution were (Murray et al., 2008). Therefore, Murray et al. (2008) suggested that finding associative effects of SBP and forage is important.

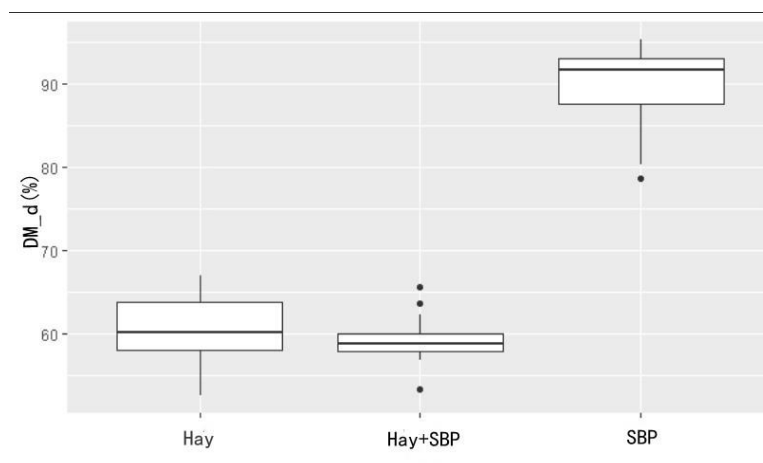

Figure 7

Dry matter digestibility (DM_d) of hay and SBP in hindgut by In-sacco method, total tract DM digestibility by In-vivo method

In comparison test of the two group of feed, hay lost approximately 21.35% DM by rinsed and washed in automatic machine. This result is similar with that of from Moore-Colyer et al. (2002) who observed 24% DM loss from the hay bags. In present study SBP dry matter losses from bags was 23.53% whereas Moore-Colyer et al. (2002) found less than 10% of SBP DM losses from bags.

6.3 Mean retention time (MRT)

By using In-sacco mobile bag technique, there were 41 out of 45 bags with SBP and 41 out of 45 bags with hay collected throughout the experiment days. The remaining 8 bags were discarded (Table 7). Bags were concentrated collected between 19.5h-44h. The first bags were collected at time point 19.5. The MRT of SBP bags was 36.17 ± 20.43 h and the MRT of hay bags was 39.98 ± 20.45 . The large differences between total tract retention time by In-vivo method in former study (21.9 h) (Jensen et al., 2014) and hindgut retention time by In-sacco method in present study is probably due to large surface area of bags that reducing passage rate and

subsequently increase MRT, which may lead over estimation of digestibility (Hyslop, 2006). Apparent digestibility tested by In-sacco method was based on amount of feedstuffs that disappeared from bags. The effect of retention time on apparent digestibility are presented in (Figure 8) and (Figure 9), and there were interactions between DM disappearance and retention time in both SBP and Hay($p<0.001$). DM disappearance increasing along with the retention time.

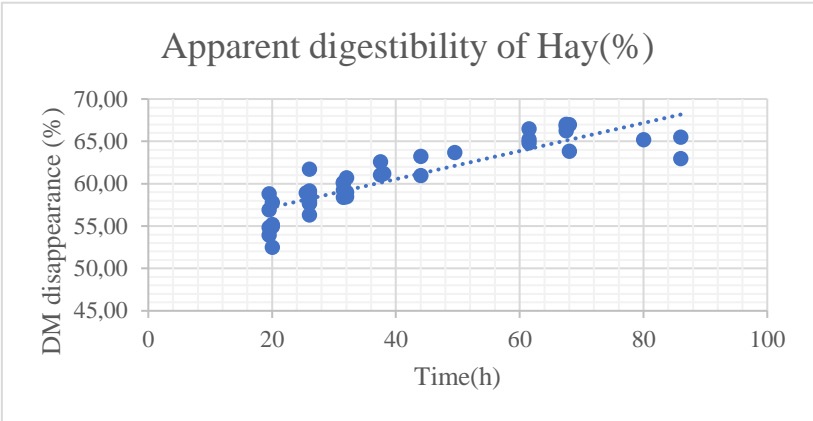

Figure 8
Dry matter (DM) disappearance from hay contained in in-sacco bags (15×1.5cm, pore size 37µm) having passed through the horse hindgut. ($R^2=0.758$)

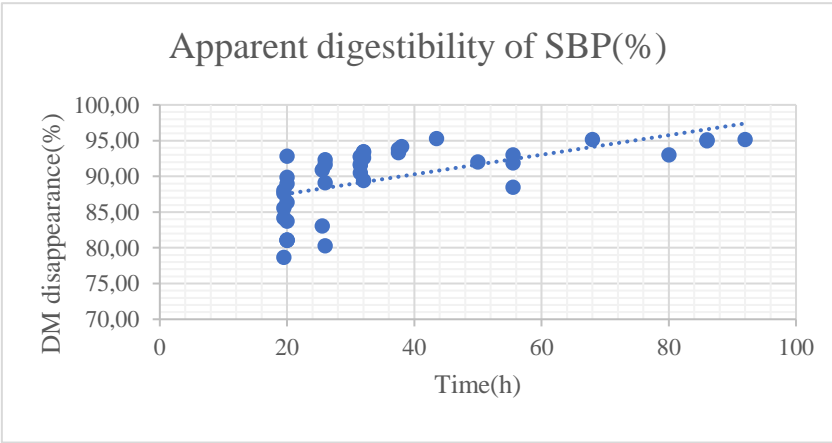

Figure 9
Dry matter (DM) disappearance from Sugar beet pulp (SBP) contained in in-sacco bags (15×1.5cm, pore size 37µm) having passed through the horse hindgut. ($R^2=0.349$)

The DM degradation profile of SBP is similar to the profile from Hyslop (2006) which allowed

mobile bag with SBP to travel throughout the whole digestive tract of horse then recovered in feces in a period of time. After incubation, the bags were started to be recovered in feces from approximately 30h (Figure 5), which is larger than that of present study (19.5h). However, Van Weyenberg et al. (2006) reported that passage time through the stomach can be 2-5h. Therefore, the result from present study is closely consistent with Hyslop (2006) study.

In the same study, Hyslop (2006) conducted another method that compared four different feed degradation through suspending bags into caecum in fixed time. Steep DM disappearance of unmolassed SBP and gentle increase of DM disappearance of hay cube can be seen from the degradation profile (Figure 4). The DM disappearance of hay cube is higher than that of SBP at starting point, this probably because hay contains larger amount of sugar than SBP. For example, sugar content of timothy hay is double the amount of that in SBP (Brøkner et al., 2012b). In present study, we found steadier degradation of SBP(coefficient=0.137) (Figure 9) than hay(coefficient=0.166) (Figure 8) through simple linear model, which is opposite to the profile from Hyslop (2006) study (Figure 4). This difference from two studies reflects one of the defects of collecting mobile bags from feces in In-sacco mobile bags technique: due to uncontrollable of MRT, it had been difficult to figure out degradation profile from starting point to the time that first bags(19.5h) were collected from feces.

Large retention time variations among different studies is probably because there are many factors that influence gastric feed retention time. Such as feeding level and diet composition and exercises are considered as important factors that affect MRT level (Austbø & Volden, 2006).

Table 7

Amount of Sugar beet pulp (SBP) and Hay in-sacco bags that found in different mean retention time (MRT)

SBP			Hay		
Retention time	Number of bags founding	Apparent DM digestibility	Retention time	Number of bags founding	Apparent DM digestibility
19.8	13	85.32±4.14	19.8	8	55.63±2.09
25.8	6	87.89±5.02	25.9	9	58.55±1.48
31.7	9	92.03±1.36	31.7	7	59.44±0.89
37.7	3	93.77±0.44	37.7	3	61.62±0.86
43.5	1	95.30	44.0	2	62.10±1.59
50	1	92.03	49.5	1	63.68
55.5	3	91.13±2.35	61.5	3	65.52±0.86
68	1	95.18	67.7	5	66.19±1.34
80	1	92.99	80	1	65.20
86	2	95.06±0.1	86	2	64.25±1.78
92	1	95.15			

6.4 Algebraic Digestibility

Total tract MRT calculation was based on observation from Jensen et al. (2014) and Austbø and Volden (2006) (Table 2). Value that after 44h was discarded because the MRT in majority of studies were between 19h to 46h (Hyslop, 2006; Jensen et al., 2014; Miyaji et al., 2011; Moore-Colyer et al., 2003; Pearson et al., 2006)

Table 8

Degradation profile fitted to dry matter disappearance of Sugar beet pulp(SBP) and hay from mobile bags recovered from horse feces, calculated diet potential apparent dry matter digestibility (DM_d) (%) of in-vivo diet (Hay+ SBP) in different mean retention time(MRT). n=bags amount

	Mean retention time(MRT)				
	20h	26h	32h	38h	44h
DM _d (%)					
SBP	85.32±4.14 (n=13)	87.89±5.02 (n=6)	92.03±1.36 (n=9)	93.77±0.44 (n=3)	95.30 (n=1)
Hay	55.63±2.09 (n=8)	58.55±1.48 (n=9)	59.44±0.89 (n=7)	61.62±0.86 (n=3)	62.10±1.59 (n=2)
Hay+SBP	57.41	60.31	61.39	63.54	64.09

Total tract mean retention time observed by Jensen et al. (2014) with marker method was 21.9h. In this retention time point(20h) the ATTD calculated through In-sacco bags was 56.82% which is slightly lower than the value (61.5%) observed by Jensen et al. (2014) This is maybe because 15% kg/day of SPP was added in the diet. whereas in present study, only 6%kg/day was used (Table 9). The increasing amount of SBP promote ATTD of DM (Murray et al., 2008). Another comparable ATTD value calculated in 26h MRT time point based on the observation from Austbø and Volden (2006), which was 60.31% (Table 9).The researcher did not report DM digestibility in his study. However, the calculated digestibility value in time point 26h (60.31%) highly conform ATTD of DM digestibility that observed in present In-vivo total feces collection method (59.15±2.59%). This result supported the hypothesis that ATTD of DM can be calculated by individual digestibility based on digestibility obtained from In-sacco method.

Table 9

Apparent total tract digestibility (ATTD) of different feed ratio (SBP/hay) in increasing mean retention time. SBP=sugar beet pulp

<i>SBP/ hay (%)</i>	MRT(h)				
	20	26	32	38	44
	ATTD (%)				
<i>6/94</i>	56.82	59.72	60.74	62.91	63.43
<i>15/85</i>	60.08	62.95	64.33	66.44	67.08
<i>30/70</i>	64.54	67.35	69.22	71.27	72.06
<i>45/55</i>	68.99	71.75	74.11	76.09	77.04
<i>55/45</i>	71.96	74.69	77.36	79.30	80.36

According to the calculation, we found that ATTD of DM increases with the increases of MRT. At the same time, increasing level of substitution of SBP also improves DM digestibility in certain MRT. The inclusion of SBP in the diet at a level higher than 55% of total diet DM among studies may limit feed intake (Olsman et al., 2004). Harris and Rodiek (1993) cited by Olsman et al. (2004) had added up to 45% DM of beet pulp into equine diet and he did not observe any signs of digestive upset or feed refusals of his experimental horses. In the calculation, 45% DM of SBP in diet could reach apparent digestibility up to 71.75% in 26h MRT (Table 9).

7 Conclusion

Result from present study demonstrate that the In-sacco mobile bag technique can be used to determine the apparent digestibility of fibrous feed in horses. The use of this technique in fistulated horses allowed individual feedstuff degradation to be measured in different segments and thereby diet apparent digestibility can be further calculated by ratio. Those are important for improving knowledge of nutrient availability and getting optimum diet for performance horses. Sugar beet pulp has extremely high nutrition value, of which averagely 89% can be utilized by hindgut microorganisms regardless of loss from bags. Substitution of Sugar beet pulp with hay increase apparent digestibility by increasing of SBP ratio. However, the upper limit of substitution need further study to approve. Increasing of mean retention time positively influences apparent digestibility of both hay and SBP.

8 Perspectives

Wide-ranging studies are needed to further develop the using of In-sacco mobile bag technique that described here. For example, different size of bags and pores can be used to evaluate influences of pore size on gastric fluid exchange and bag size on mean retention time. Furthermore, different nutrients digestibility in feedstuffs can be examined by In-sacco method. For example, crude protein, lipids and fiber digestion can be analyzed to further evaluate feedstuffs.

Sugar beet pulp is highly nutritious fibrous source for horses. Digestibility of different proportion of sugar beet pulp in basal diet calculated here required to be examine in practice by In-vivo with different forages. Finding optimum effects of sugar beet pulp ratio with basal forage is important to maximize feed digestibility efficiency.

9 Acknowledgement

Firstly, I would like to express my sincere gratitude to my supervisor Postdoc Rasmus Bovbjerg Jensen from department of animal and aquacultural sciences, Norwegian University of life sciences for many insightful conversations during the development of the ideas in this thesis, helpful and practical skills teaching during the experiment and for helpful comments throughout the learning process.

Thank to Engineer Mette Henne from department of animal and aquacultural sciences, Norwegian university of life sciences provided me technical help and master student Marie Rønn from University of Copenhagen gave me useful advices and practical help and thank to Adiya Suyilatu from University of Social Sciences and Humanities of Poland for the text improvement.

10 References

- Austbø, D. & Volden, H. (2006). Influence of passage model and caecal cannulation on estimated passage kinetics of roughage and concentrate in the gastrointestinal tract of horses. *Livestock science*, 100 (1): 33-43.
- Bach Knudsen, K. E. (1997). Carbohydrate and lignin contents of plant materials used in animal feeding. *Animal feed science and technology*, 67 (4): 319-338.
- Bach Knudsen, K. E. (2001). The nutritional significance of “dietary fibre” analysis. *Animal feed science and technology*, 90 (1-2): 3-20.
- Bergman, E. (1990). Energy contributions of volatile fatty acids from the gastrointestinal tract in various species. *Physiological reviews*, 70 (2): 567-590.
- Blaxter, K. L., Graham, N. M. & Wainman, F. (1956). Some observations on the digestibility of food by sheep, and on related problems. *British journal of nutrition*, 10 (2): 69-91.
- Brøkner, C., Austbø, D., Næsset, J. A., Knudsen, K. E. B. & Tauson, A.-H. (2012a). Equine pre-caecal and total tract digestibility of individual carbohydrate fractions and their effect on caecal pH response. *Archives of animal nutrition*, 66 (6): 490-506.
- Brøkner, C., Knudsen, K. B., Karaman, I., Eybye, K. & Tauson, A.-H. (2012b). Chemical and physicochemical characterisation of various horse feed ingredients. *Animal feed science and technology*, 177 (1-2): 86-97.
- Cuddeford, D. (1994). Artificially dehydrated lucerne for horses. *The veterinary record*, 135 (18): 426-429.
- Earing, J., Cassill, B., Hayes, S., Vanzant, E. & Lawrence, L. (2010). Comparison of in vitro digestibility estimates using the Daisy II incubator with in vivo digestibility estimates in horses 1. *Journal of animal science*, 88 (12): 3954-3963.
- Harris, D. & Rodiek, A. (1993). *Dry matter digestibility of diets containing beet pulp fed to horses*. Equine nutrition and physiology symposium, 13. proceedings.
- Hoffman, R., Wilson, J., Kronfeld, D., Cooper, W., Lawrence, L., Sklan, D. & Harris, P. (2001). Hydrolyzable carbohydrates in pasture, hay, and horse feeds: direct assay and seasonal variation. *Journal of animal science*, 79 (2): 500-506.
- Huntingdon, J. & Givens, D. (1995). The in situ technique for studying the rumen degradation of feeds: a review of the procedure. *Nutrition abstracts and reviews. series B, livestock feeds and feeding (United Kingdom)*.
- Hymøller, L., Dickow, M. S., Brøkner, C., Austbø, D. & Jensen, S. K. (2012). Cereal starch, protein, and fatty acid pre-caecal disappearance is affected by both feed technological treatment and efficiency of the chewing action in horses. *Livestock science*, 150 (1): 159-169.
- Hyslop, J. (2006). In situ and mobile bag methodology to measure the degradation profile of processed feeds in different segments of the equine digestive tract. *Livestock science*, 100 (1): 18-32.
- Jensen, R., Austbø, D., Knudsen, K. B. & Tauson, A.-H. (2014). The effect of dietary carbohydrate composition on apparent total tract digestibility, feed mean retention time, nitrogen and water balance in horses. *animal*, 8 (11): 1788-1796.

- Jensen, R. B., Austbø, D., Blache, D., Bach Knudsen, K. E. & Tauson, A. H. (2016). The effect of feeding barley or hay alone or in combination with molassed sugar beet pulp on the metabolic responses in plasma and caecum of horses. *Animal feed science and technology*, 214: 53-65.
- Julliand, V., De Fombelle, A. & Varloud, M. (2006). Starch digestion in horses: the impact of feed processing. *Livestock science*, 100 (1): 44-52.
- Lewis, L. D. (1995). *Equine clinical nutrition: feeding and care*: Williams & Wilkins.
- Lindberg, J. & Karlsson, C. P. (2001). Effect of partial replacement of oats with sugar beet pulp and maize oil on nutrient utilisation in horses. *Equine veterinary journal*, 33 (6): 585-590.
- Lowman, R., Theodorou, M., Hyslop, J., Dhanoa, M. & Cuddeford, D. (1999). Evaluation of an in vitro batch culture technique for estimating the in vivo digestibility and digestible energy content of equine feeds using equine faeces as the source of microbial inoculum. *Animal feed science and technology*, 80 (1): 11-27.
- Luthersson, N., Nielsen, K., Harris, P. & Parkin, T. (2009a). Risk factors associated with equine gastric ulceration syndrome (EGUS) in 201 horses in Denmark. *Equine veterinary journal*, 41 (7): 625-630.
- Luthersson, N., Nielsen, K. H., Harris, P. & Parkin, T. (2009b). Risk factors associated with equine gastric ulceration syndrome (EGUS) in 201 horses in Denmark. *Equine veterinary journal*, 41 (7): 625-630.
- McDonald, P. (2002). *Animal nutrition*: Pearson education.
- McLean, B., Hyslop, J., Longland, A., Cuddeford, D. & Hollands, T. (2000). Physical processing of barley and its effects on intra-caecal fermentation parameters in ponies. *Animal feed science and technology*, 85 (1-2): 79-87.
- Meyer, H., Radicke, S., Kienzle, E., Wilke, S., Kleffken, D. & Illenseer, M. (1995). Investigations on preileal digestion of starch from grain, potato and manioc in horses. *Transboundary and emerging diseases*, 42 (1-10): 371-381.
- Miraglia, N., Poncet, C. & Rosset, W. M. (1992). *Effect of feeding level, physiological state and breed on the rate of passage of particulate matter through the gastrointestinal tract of the horse*. Annales de zootechnie.
- Miraglia, N., Bergero, D., Bassano, B., Tarantola, M. & Ladetto, G. (1999). Studies of apparent digestibility in horses and the use of internal markers. *Livestock production science*, 60 (1): 21-25.
- Miyaji, M., Ueda, K., Kobayashi, Y., Hata, H. & Kondo, S. (2008). Fiber digestion in various segments of the hindgut of horses fed grass hay or silage. *Animal science journal*, 79 (3): 339-346.
- Miyaji, M., Ueda, K., Hata, H. & Kondo, S. (2011). Effects of quality and physical form of hay on mean retention time of digesta and total tract digestibility in horses. *Animal feed science and technology*, 165 (1-2): 61-67.
- Moore-Colyer, M. J., Hyslop, J., Longland, A. & Cuddeford, D. (2002). The mobile bag technique as a method for determining the degradation of four botanically diverse fibrous feedstuffs in the small intestine and total digestive tract of ponies. *British journal of nutrition*, 88 (6): 729-740.
- Moore-Colyer, M. J., Morrow, H. & Longland, A. (2003). Mathematical modelling of digesta passage rate, mean retention time and in vivo apparent digestibility of two different lengths of hay and big-bale grass silage in ponies. *British journal of nutrition*, 90 (1): 109-118.
- Müller, C. & Udén, P. (2007). Preference of horses for grass conserved as hay, haylage or silage. *Animal feed science and technology*, 132 (1-2): 66-78.

- Murray, J.-A. M., Longland, A., Hastie, P. M., Moore-Colyer, M. & Dunnett, C. (2008). The nutritive value of sugar beet pulp-substituted lucerne for equids. *Animal feed science and technology*, 140 (1-2): 110-124.
- Murray, J.-A. M., Sanderson, R., Longland, A. C., Moore-Colyer, M. J., Hastie, P. M. & Dunnett, C. (2009). Assessment of mathematical models to describe the rate of passage of enzyme-treated or sugar beet pulp-substituted lucerne silage in equids. *Animal feed science and technology*, 154 (3-4): 228-240.
- Nadeau, J. A., Andrews, F. M., Mathew, A. G., Argenzio, R. A., Blackford, J. T., Sohtell, M. & Saxton, A. M. (2000). Evaluation of diet as a cause of gastric ulcers in horses. *American journal of veterinary research*, 61 (7): 784-790.
- NorFor in sacco standard*. (2007).
- Noziere, P. & Michalet-Doreau, B. (2000). In sacco methods. *Farm animal metabolism and nutrition*. London: CAB International: 233-253.
- Olsman, A., Huurdeman, C., Jansen, W., Haaksma, J., Oldruitenborgh-Oosterbaan, M. & Beynen, A. (2004). Macronutrient digestibility, nitrogen balance, plasma indicators of protein metabolism and mineral absorption in horses fed a ration rich in sugar beet pulp. *Journal of animal physiology and animal nutrition*, 88 (9-10): 321-331.
- Ordakowski, A., Kronfeld, D., Holland, J., Hargreaves, B., Gay, L., Harris, P., Dove, H. & Sklan, D. (2001). Alkanes as internal markers to estimate digestibility of hay or hay plus concentrate diets in horses. *Journal of animal science*, 79 (6): 1516-1522.
- Pearson, R., Archibald, R. & Muirhead, R. (2001). The effect of forage quality and level of feeding on digestibility and gastrointestinal transit time of oat straw and alfalfa given to ponies and donkeys. *British journal of nutrition*, 85 (5): 599-606.
- Pearson, R., Archibald, R. & Muirhead, R. (2006). A comparison of the effect of forage type and level of feeding on the digestibility and gastrointestinal mean retention time of dry forages given to cattle, sheep, ponies and donkeys. *British journal of nutrition*, 95 (1): 88-98.
- Ragnarsson, S. & Lindberg, J. E. (2008). Nutritional value of timothy haylage in Icelandic horses. *Livestock Science*, 113 (2): 202-208.
- Ragnarsson, S. & Lindberg, J. (2010). Impact of feeding level on digestibility of a haylage-only diet in Icelandic horses. *Journal of animal physiology and animal nutrition*, 94 (5): 623-627.
- Rodrigues, L. M., Almeida, F. Q. d., Pereira, M. B., Miranda, A. C. T., Guimarães, A. & Andrade, A. M. d. (2012). Roughage digestion evaluation in horses with total feces collection and mobile nylon bags. *Revista brasileira de zootecnia*, 41 (2): 341-346.
- Rowe, J. B., Lees, M. J. & Pethick, A. W. (1994). Prevention of acidosis and laminitis associated with grain feeding in horses. *The journal of nutrition*, 124 (12): 2742S.
- Sales, J. & Janssens, G. (2003). Acid-insoluble ash as a marker in digestibility studies: a review. *Journal of animal and feed sciences*, 12 (3): 383-400.
- Schneider, B. H. & Flatt, W. P. (1975). *The evaluation of feeds through digestibility experiments*: University of Georgia Press.
- Van Weyenberg, S., Sales, J. & Janssens, G. (2006). Passage rate of digesta through the equine gastrointestinal tract: A review. *Livestock science*, 99 (1): 3-12.