

NORWEGIAN UNIVERSITY OF LIFE SCIENCES



Effect of Red Light on Sporulation of *Neozygites floridana* on *Tetranychus urticae* host.

Master thesis in Agroecology

Maren Pindsle Holthe



Norwegian University of Life Science

Department of Plant and Environmental Science

Spring 2012

Preface

This master thesis is part of the BERRYSSYS project, aiming to increasing organic and integrated berry production in high plastic tunnels. The project has a systematic approach towards handling some of the challenges in strawberry production by looking at the interactions between the two spotted spider mite, its natural enemies (mite pathogenic fungus and predatory mites) and powdery mildew. The project is run by the Norwegian Institute for Agricultural and Environmental Research (Bioforsk) and funded by Agricultural Agreement Research Funds (Forskingsmidler over Jordbruksavtalen, JA) and Norwegian Foundation of Research Levy on Agricultural Products (Fondet for forskningsavgift på landbruksprodukter, FFL), project number 190407/199. Collaborating partners are Koppert Biological Systems, The Netherlands, and scientist at the Agricultural Faculty of São Paulo University (USP-ESALQ), Brazil. Preparations and the experiment as a whole were completed by the end of October 2011. Data registration was done continually while the experiment was running and completed in January 2012. The writing process took place in the spring semester, February until mid-May, of 2011.

I would like to thank my supervisor and project leader at Bioforsk Plant Health and Plant Protection Dr. Ingeborg Klingen for guiding me through the scientific process from experiment to finished thesis. Professor Tor Arvid Breland at the University of Life Sciences (UMB) was also a great support to keep me on the agroecology path throughout this thesis. Karin Westrum, sectional engineer at Bioforsk, was a great support and inspirational discussion partner. Aregahegn Nega Yiketem is thanked for helping me complete the tremendous amount of spore counting during the data collection phase. Statistical help from Torfinn Torp at Bioforsk was more than expected. Thank you to Aruppillai Suthaparan for introducing me to knowledge about light and for completing the setup of the experiment. Jørn Medlien at SKP and Ida Kristin Hagen at IPM are also thanked for technical support during the experimental period. Eva Brod was a great support throughout the entire thesis process and helped out in language and Word technicalities. Anita Nipen helped out with language corrections. This thesis would not have been the same without any of the above mentioned.

Abstract

The mite pathogenic fungi *Neozygites floridana* is an important natural enemy to the polyphagous two-spotted spider mite *Tetranychus urticae*. In order to increase the efficacy of *N. floridana* in conservational biological control, two experiments on how direct and indirect light (light:dark ratio, intensity/quantity and quality) affects sporulation of *N. floridana* on cadavers from its natural host *T. urticae* were conducted. Controlled climatic chambers gave the same ambient conditions of 20 °C and 70 % RH. Two light regimes were used and went as follows: 12 h HPS 150 $\mu\text{mol m}^{-2} \text{s}^{-1}$ for both treatments, 4h of Red LED 50 $\mu\text{mol m}^{-2} \text{s}^{-1}$ for the red light treatment and parallel 4 h of white HPS 50 $\mu\text{mol m}^{-2} \text{s}^{-1}$ for white light treatment. Both treatments had darkness for the proceeding 8 h. Indirect light effect was studied by placing two strawberry plants with 90 *N. floridana* infected *T. urticae* on each plant in light emitting tunnels with a 24 h spore catcher in each light treatment. The freshly killed cadavers were left to sporulate during the 8 days of the experiment with the tape on the spore catcher changed every 24 h. The difference between *N. floridana* spores discharged in red and white light treatment proved to be time dependent ($P=0.00$). Spore discharge started during the hours of red light treatment and continued through the dark hours while under white light spore discharge did not start until the dark hours. It is difficult to say if the total number of spores discharged was affected by the different light regimes ($P=0.00$) as the total number of spores discharged in the white regime varied considerably between the tunnels. The effect of 24 h direct light exposure from the two light treatments on *N. floridana* killed *T. urticae* cadavers mounted on a coverslip with grid was not significantly different ($P=0.256$). The total number of spores discharged varied considerably within each light treatment, resulting in large standard deviations. As the results from the indirect light experiment show, the prolonged sporulation under red light could increase the performance of *N. floridana* in biological control of *T. urticae* populations.

Key words: *Tetranychus urticae*, *Neozygites floridana*, light quality, trophic interactions, strawberry, mite pathogenic fungi; biological control.

Table of content

1	Introduction	1
2	Materials and Methods	6
2.1	T. urticae stock culture	6
2.2	N. floridana isolate	6
2.3	Cadaver production	6
2.4	Production of strawberry plants used in the experiment	7
2.5	Experimental setup	7
2.5.1	<i>Number of spores discharged from cadavers on whole plants</i>	<i>7</i>
2.5.2	<i>Number of spores discharged from cadaver on microscope slides.....</i>	<i>10</i>
2.6	Data registration	11
2.6.1	<i>Counting spores from cadavers on whole plant experiment.....</i>	<i>11</i>
2.6.2	<i>Counting spores from cadaver on slide experiment.....</i>	<i>11</i>
2.7	Statistic analysis	12
2.7.1	<i>Number of spores from cadaver on whole plant experiment</i>	<i>12</i>
2.7.2	<i>Number of spores form cadaver on slide experiment.....</i>	<i>12</i>
3	Results	13
3.1	Number of spores discharged from cadavers on whole plants	13
3.2	Numbers of spores discharged from cadavers on slides.....	18
4	Discussion.....	19
4.1	Number of spores discharged from cadavers on whole plants	19
4.2	Numbers of spores discharged from cadavers on slide	22
4.3	Outlook.....	23
5	Conclusion.....	24
6	References	25
7	Appendix	29

Tables and figures

Table 1. Average light intensity, temperature, RH and Red light ratio in the two treatments.	10
Table 2. Mean numbers of <i>Neozygites floridana</i> spores discharged from <i>N. floridana</i> killed <i>Tetranychus urticae</i> cadavers exposed on slides directly to the different light treatments (red and white as described in Table 1). n=15.....	18
Figure 1. Schematic illustration of the wind tunnel used in the experiment. (a) An electric wind fan with manually adjustable speed control (b) Synthetic filter (c) Overflow orifice (29 mm in diameter) (d) Nozzle orifice, 27 by 2 mm (e) Rotating plastic bottle fixed to an electrical timer, 24 hr rotations (f) Melinex microscope tape. (Suthaparan et al., 2010a)	8
Figure 2. Tunnel with plants with <i>N. floridana</i> inoculated <i>T. urticae</i> and a spore trap.....	9
Figure 3. <i>T. urticae</i> cadaver with the dorsal side up mounted on a slide for sporulation in plastic box. Figure from (Nilsen, 2007).	11
Figure 4. <i>Neozygites floridana</i> daily spore discharge from <i>N. floridana</i> killed <i>Tetranychus urticae</i> cadavers on strawberry plants exposed to two different light treatments (red and white as described in Table 1).....	15
Figure 5 a-h. <i>Neozygites floridana</i> hourly spore discharge from <i>N. floridana</i> killed <i>Tetranychus urticae</i> cadavers on bean plants exposed to two different light treatments (red and white as described in Table 1). Note the varying y-axis values.	17

1 Introduction

Agriculture may be viewed as a large system consisting of components such as the environment, economic and social structures that all interact (Gliessmann, 2004). Through farming, human-kind transforms natural ecosystems into human constructed ecosystems (Sastrapradja, 1988). In natural ecosystems, flow of energy, nutrients and internal regulations take place through the existence and interactions between species of plants, animals and micro-organism. Biodiversity in ecosystems play an important role in keeping the ecosystem sound as it provides several ecological services such as recycling of nutrients, natural regulations of plant and animal populations and controlling the local microclimate (Altieri, 1999). To describe the sustainability of an agricultural system the production system may be viewed as an agroecosystem. Humans are an important part of the agroecosystem as we alternate and manipulate the structure and function of the natural ecosystem in order to establish agricultural production (Gliessmann, 2004).

A sustainable agroecosystem and applied agroecology is defined by Gliessmann (2004) and Sastrapradja (1988) as ecological principles and concepts applied to an agricultural system. Natural feedback loops will interact in the production system and maintain the balance within the fluctuating boundaries of the agroecosystem (Lewis et al., 1997). The ecology of the entire food system with the interactions between ecology, economy and social dimensions are also part of the same definition (Francis et al., 2003). Key indicators of agroecosystem sustainability (energy flow, nutrient cycling and population regulating mechanisms) will only manifest themselves once all of the system components are organized (Gliessmann, 2004). The persistence of an agroecosystems is dependent upon maintenance of biological diversity (Altieri, 1999) which is challenging as disturbance such as tillage and harvesting of crops will interfere with the system's successional development (Gliessmann, 2007). The principles for sustainable agriculture have been supported and reinsured through the report from International Assessment of Agriculture, Knowledge, Science and Technology for Development (IAASTD, 2009) and by the United Nations Special Rapporteur De Schutter (2010).

In today's industrialized agriculture much of the balance between the previously mentioned components has been lost (Gliessmann, 2004) as the production of food is concentrated around a limited number of species in large scale monocultures (Oerke & Dehne, 2004). Through the

Green Revolution in the 20th century ecosystems and biodiversity have been simplified into systems that constantly require human regulation and intervention with external inputs such as fossil fuels, fertilizers and pesticides (Altieri, 1999; Gliessmann, 2004; Oerke & Dehne, 2004), making the system vulnerable, sometimes unstable and often with negative impacts on the resource base and the environment. The widespread use of pesticides has led to an increase in food production, but with consequences such as damage to human health, loss and disruption of biodiversity, residue buildup in soil, contamination of rivers and lakes, bioaccumulation, resistance towards the chemicals used and outbreaks of secondary pests (Gomiero et al., 2011; Pimentel et al., 1992; Wilson & Tisdell, 2001).

A holistic view and sustainable resolutions on plant protection is needed as today's intensified short-term relief through spraying has not managed to reduce the amounts of crops lost by pests throughout the years (Gliessmann, 2007; Lewis et al., 1997; Oerke & Dehne, 1997; Oerke & Dehne, 2004). Despite the increased use of pesticides and higher yields of most crops, there has been an increase of 4-10% in the annual amount of crops such as wheat, potatoes, barley and rice lost to pathogens, animal pest and weeds since 1965 (Oerke & Dehne, 1997; Oerke & Dehne, 2004). Changing of diet preference towards more meat and milk products increases the pressure for more intensified farming. To be able to provide enough food and feed for the increasing population pest management is a major prerequisite (Oerke & Dehne, 2004). Plant protection systems designed to promote multitrophic interactions that enforce more natural control of pest populations (Lewis et al., 1997) is an alternative to today's chemically based pesticide strategy.

An alternative strategy to pesticides is the use of biological control (or biocontrol) to regulate the pest population. Biocontrol is defined by Eilenberg et al. (2001) as *“the use of living organisms to suppress the population density or impact of a specific pest organism, making it less abundant or less damaging than it would otherwise be”*. Organisms used in biocontrol are natural enemies of the pest and can be used in four different controlling strategies: 1) Classical biological control: Control of an exotic pest. The biocontrol organism introduced is usually co-evolved with the imported pest. Permanent establishment of the natural enemy will provide a long term, but not always complete, control of the pest (Eilenberg et al., 2001; Pell et al., 2001). 2) A less permanent effect is achieved through inoculation biological control. Low numbers of the natural enemy is released, usually in the early production phase. The success of this approach is dependent on the natural enemy's ability to multiply after release, and thereby reducing the pest population, for an extended period of time (e.g. one season) but not on a permanent basis (DeBach & Rosen,

1991; Eilenberg et al., 2001; Pell et al., 2001). 3) In inundative biological control the pest control is achieved exclusively through the (mass) release of the natural enemy, and not through its progeny as in the inoculation biological control. Inundative biological control is a short term biological control strategy (DeBach & Rosen, 1991; Eilenberg et al., 2001; Pell et al., 2001). 4) Conservation biological control is obtained by modifying and manipulating the environment in order to protect and enhance the already occurring natural enemies. Natural enemies are not released, but through protection and resource providing actions they are conserved and enhanced in order to increase their controlling effect. Limited and selective use of pesticides are also included in conservational biological practice (DeBach & Rosen, 1991; Eilenberg et al., 2001; Pell et al., 2001).

The use of different biological control methods is an important part of Integrated Pest Management (IPM). The Food and Agricultural Organization of the United Nations (FAO) defined in 1967 IPM as *“a pest management system that in context of the associated environment and the population dynamics of the pest species, utilizes all sustainable techniques and methods in as compatible a manner as possible and maintains the pest populations at levels below those causing economic injury”* (FAO, 1967). Dent (1995) later included the socioeconomic contexts of farming systems as a part of the IPM definition. The general principles in IPM focuses on coping with pests in agriculture through diverse actions such as knowledge of the plant and pest biology and their interactions, frequent monitoring of the pest population, different measures keeping the pest population below the economical threshold value. For pest control the use of non-chemical methods such as biological control is preferred prior to the use of chemical pesticides (BiPRO, 2009; Hofsvang, 2010; Pell et al., 2001). The European Union (EU) has decided that all farms must practice IPM by the 1st of January 2014 (BiPRO, 2009). Although IPM has been practiced in Norway since 1960 (Hofsvang, 2010), the Norwegian government is now reinforcing IPM as a part of the action plan towards reducing the risks associated with the use of pesticides in Norwegian agriculture (Landbruks- og matdepartementet, 2009). In the Bioforsk project titled *“BERRYSYS –A system approach to biocontrol in organic and integrated strawberry production”* a holistic approach has been taken to study the interactions between several organisms at several trophic levels in order to face the plant protection challenges in strawberry production. Interactions between plants, plant pests and plant pathogens and their natural enemies have resulted in an experimental approach based on conservation, inoculation and inundation biological control.

Strawberries are by far the largest berry production and the second largest horticulture product in Norway (Statistisk sentralbyrå, 2011). The season is short and intense, with a high economical stake if the season fails. Strawberries are vulnerable to several pathogens, pest insects and mites which stimulates a widespread use of pesticides. Out of all strawberry fields in Norway 94% are sprayed with pesticides, out of this 81 % are sprayed with fungicides and 91 % with insecticides. In general, there has been an increase over the years in the amount of land sprayed (Aarstad et al., 2009). Pesticide residues were found both in Norwegian produced and imported strawberries in 2010, but the amounts of residues did not exceed the maximum residual level (MRL) for pesticides (Skretteberg et al., 2011).

An important pest of strawberries is the polyphagus two-spotted spidermite, *Tetranychus urticae* (Acari: Tetranychidae). In hot and dry periods during the summer, the feeding of *T. urticae* reduces the plant's rate of photosynthesis and transpiration, which again leads to reduced quality and quantity of berries. Yield losses may reach 25 % especially after large infestation early in the season, and severe infestation in one season can lead to low yields the following season (Cross et al., 2001; Tomczyk & Kropczynska, 1985). The conventional way of controlling *T. urticae* is to spray with chemical insecticides (Sato et al., 2007). It is challenging to control *T. urticae* by spraying as they are located underneath the leaf surface, making it difficult to reach the target. *T. urticae* has developed resistance against many chemical acaricides, and this makes it even more challenging to control *T. urticae* populations (Cross et al., 2001; Sato et al., 2007; Wekesa et al., 2011). Many acaricides are quite nonspecific and broad-ranging and hence they may kill insect pests as well as their natural enemies (Kennedy & Smitley, 1988). Invasion of *T. urticae* is a classic example of secondary pest outbreaks due to suppression of natural enemies from the use acaricides to reduce the primary pest (Brandenburg & Kennedy, 1987; Klingen & Westrum, 2007; Prischmann et al., 2005).

The mite pathogenic fungus *Neozygites floridana* (Zygomycetes: Entomophthorales) is a natural enemy of *T. urticae* and may cause epizootics in *T. urticae* populations, and hence reduce *T. urticae* numbers to a level where the damages on the crop plants is unsubstantial (Kennedy & Smitley, 1988; Oduor et al., 1996; Wekesa et al., 2011). *N. floridana* conidia are actively ejected from *N. floridana* killed *T. urticae* cadavers to the surrounding environment and develop into the infective capilliconidia (secondary conidia), ready to attach to new *T. urticae* host. Under favorable conditions, these conidia will form a germ tube and penetrate the hosts cuticle by enzymatic and physical means (Nielsen, 2002). After entering *T. urticae*, *N. floridana* develops into hyphal bodies and multiplies inside the host body through budding, causing physiological starvation.

After killing *T. urticae* the fungus will penetrate through the cuticle and produce primary conidia (spores) on conidiophores (spore bearing structures). A successful epizootic development of *N. floridana* in a *T. urticae* population depends on important abiotic factors such as temperature, relative humidity and light (Carner, 1976; Klingen & Westrum, 2007; Nielsen, 2002; Oduor et al., 1996; Pell et al., 2001; Tanada & Kaya, 1993).

New knowledge on reduced efficacy of *N. floridana* if a crop is sprayed with certain fungicides (Klingen & Westrum, 2007; Wekesa et al., 2008) must be taken into account when practicing conservational biological control and integrated pest management. To obtain such knowledge is important in order to succeed with biological control and integrated pest management. By bridging the gap between such knowledge and practice it might be possible to give the farmers the right plant protection tools and information to choose the right actions at the right time.

In conservational biocontrol the production system is manipulated to favor the natural enemy of the pest. In order to succeed with the conservation strategy it is important to understand the biology and the interactions between the plant, the plants pest and the natural enemies of the pest to know when to implement the most effective measures. One way of manipulating the system is to control light quality, intensity and photoperiods. A previous study by Oduor et al. (1996) revealed the importance of photoperiod on the production and release of *N. floridana* spores from the natural host cassava green mite (*Mononychellus tanajoa*) mounted on slides. Castro et al. (2010) also proved an effect of different photoperiods and light intensities on sporulation of *N. floridana* killed *T. urticae* cadavers on slides. A few papers also present some studies on the effect of light quality on sporulation of *Entomophthora* spp from culture media plates (Callaghan, 1969; Ege, 1965; Wilding, 1970). A recent study with the plant pathogenic fungus *Podosphaera pannosa* demonstrates a decrease in conidia release of under 18 h white light and 6 h red light (575-675 nm) compared to 18 h white light and 6 h darkness. Also a brief illumination of 1 h of red light during the dark period in 18 h white light and 6 h darkness regime showed a reduction of released conidia. The study was conducted on whole rose plants (*Rosa x hybrida*) in a wind tunnel (Suthaparan et al., 2010b). To our knowledge, no studies on the effects of light quality on the sporulation biology of *N. floridana* from *T. urticae* cadavers have been conducted, however. The aim of this study was therefore to gather information on how light quality affects the sporulation of *N. floridana* from its natural host *T. urticae*. This was done by exposing 1) Whole strawberry plants with *N. floridana* inoculated *T. urticae* and 2) *N. floridana* killed *T. urticae* cadavers on cover slips to different light regimes.

2 Materials and Methods

2.1 *T. urticae* stock culture

T. urticae were kept on bean plants, *Phaseolus vulgaris* L (Masai), in a plexiglass cage in a culture room at 21 °C, 60% RH, and L18:D6. The plants were watered twice a week. Old and weak plants were replaced when needed.

2.2 *N. floridana* isolate

The *N. floridana* isolate ESALQ 1420 used in these experiments was collected from its natural host *T. urticae* on Jack bean, *Canavalia ensiformis*, in Piracicaba, Sao Paulo, Brazil (22°42' 30" S, 47° 38' 00" W, Altitude: 546 m).

2.3 Cadaver production

N. floridana killed *T. urticae* cadavers were produced as follows: Leaf discs (1,8 cm in diameter) from *P. vulgaris*, were placed with the underside up on 1,5% water agar in a Petri dish (5 cm in diameter and 2 cm high). Three *N. floridana* killed *T. urticae* cadavers were placed with their dorsal side up on a leaf nerve on the leaf disc. Petri dishes with cadavers on leaf disks were then placed in a plastic box (22x16x7 cm) covered with aluminum foil for darkness, and incubated at 20 °C, 90% RH and L18:D6 for 24 h. Cadavers were checked for good sporulation and production of capilla conidia after 24 h of incubation. If the development of capilla conidia was poor, the samples were incubated for another 24 h. After satisfying development of capilla conidia was observed, 30 *T. urticae* healthy females were placed on each leaf disc with cadavers, by the use of a paint brush, for *N. floridana* infection. Water was added to the water agar surrounding the leaf disk in the Petri dish to prevent the mites from leaving the leaf disk. *T. urticae* were then incubated for 24 h under the same conditions as described above. Leaf discs with *N. floridana* inoculated *T. urticae* were collected after 24 h and placed on fresh bean plants. The mites then walked of the leaf disc and onto the fresh bean plant and stayed there until they died and mummified. Pods and tendrils were removed to prevent the plant from dangling and the *T. urticae*

from crawling of. Leaves that overlapped or grew close together were also cut off to ensure a drier microclimate preventing the newly mummified cadavers from sporulating. Plants with *N. floridana* inoculated *T. urticae* were kept under ambient laboratory conditions at 22-25 °C, RH 20-30 % and 24 h light. Dry, non-sporulating cadavers produced on the plant were collected after 7-10 days and kept in small, unbleached cotton cloth placed in 1,8 ml NUNC Cryo Tube™ vials and stored in the fridge at 5 °C until used in the experiment. The procedure was repeated until the amount of needed cadavers was produced.

2.4 Production of strawberry plants used in the experiment

The plants used in the experiment were two month old *Fragaria x ananassa* (Korona) grown from runners at 24 °C, 60% RH day and 70% RH night and L16:D8 and 130 $\mu\text{mol m}^{-2} \text{s}^{-1}$. The plants were fertilized with Yara NPK 11-5-18 mikro mixed in water to reach electrical conductivity (EC) of 1,9 ds m^{-1} . The fertilizer solution was given when needed.

2.5 Experimental setup

2.5.1 Number of spores discharged from cadavers on whole plants

To reveal whether sporulation of *N. floridana* from *T. urticae* cadavers on a whole strawberry plant is affected by light quality during a 24 h cycle, a plant in tunnel experimental method was used (Figure 1). The method was previously developed for experiments with plant pathogenic fungi by Suthaparan et al. (2010a).

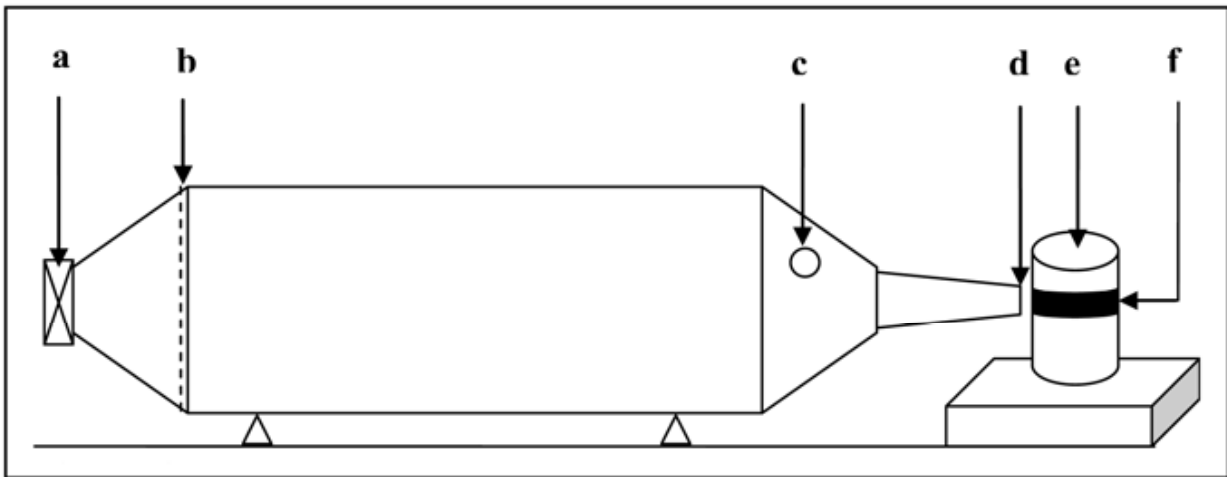

Figure 1. Schematic illustration of the wind tunnel used in the experiment. (a) An electric wind fan with manually adjustable speed control (b) Synthetic filter (c) Overflow orifice (29 mm in diameter) (d) Nozzle orifice, 27 by 2 mm (e) Rotating plastic bottle fixed to an electrical timer, 24 hr rotations (f) Melinex microscope tape. (Suthaparan et al., 2010a)

The middle section of the tunnels was made out of a light transmitting Plexiglas tube (main tube: 500 mm in length, 250 mm in diameter, approximately 3 mm thick). Each end of the tunnel ended in a funnel. A small electric fan, running at 9 V speed (Enermax UC-8FAB, China, manually adjustable), was attached to one of the funnels. The intake air was drawn through a 2 cm thick synthetic filter (FILTRAIR; Peregrine Industries Pvt. Ltd, Australia) to ensure cleaned air flow. The opposite funnel had a small opening (27 by 2 mm), letting material blown by the fan to pass through the tunnel and through the opening. Close to the opening a spore trap was placed on a 24 h rotating timer. Each spore traps consisted of Melinex microscope tape, 345 mm, fitted around 1 ½ liter bottles. A solution of 9 gr clear vaselin, 1 gr fluid paraffin and 100 ml of Toulén was heated in warm water and “painted” onto the tape with a paint brush. The Toulén solution ensured the spores would stick to the tape and be conserved until counting. In the center of each tunnel, two pots of strawberry plants were placed with a distance of 10 cm (Figure 2). The plants were thoroughly watered before the tunnels were sealed with duct tape.



Figure 2. Tunnel with plants with *N. floridana* inoculated *T. urticae* and a spore trap.

Three leaf discs with 30 *N. floridana* inoculated *T. urticae* were placed on each of the two plants in the tunnel giving 90 *N. floridana* inoculated *T. urticae* on each plant. The fan operated from the second day of the experiment (third day of the *N. floridana* inoculation period), enabling mites to settle on the plant and minimizing the chance of mites getting blown off the plant.

The tunnels were placed in climatic chambers at different light quality regimes, at the Center for Plant Research in Controlled Climate (SKP), at the Norwegian University of Life Sciences, Ås. See Table 1 for light, temperature and RH settings in the different treatments. In both treatments, plants with *N. floridana* inoculated *T. urticae* were exposed to 8 h of darkness and 12 h of High Pressure Sodium (HPS) light (MASTER SON-T Agro, Watt: 400W). Treatment one was treated with an additional 4 h of red light (598-671 nm) from two light emitting diodes (LED) (Producer unknown, 162 W), while treatment two was kept as a control with low intensity HPS (MASTER SON-T Agro, 400W) in the corresponding 4 hours. All light settings were measured with a Quantum/Radiometer/Photometer (LI-COR. Model LI-250 Light Meter. Serial no. LMA-301, U.S.A). The red light ratio inside the tunnel at plant height above and below the leaf surface of the strawberry plants during the red light treatment was measured by using SKYE Instruments, 660/730 Sensor.

Table 1. Average light intensity, temperature, RH and Red light ratio in the two treatments.

Hours	Treatment 1: Red light treatment	Treatment 2: White light treatment
07:00-19:00 (12 h)	HPS $141,1 \pm 9,2 \mu\text{mol m}^{-2} \text{s}^{-1}$	HPS $148,2 \pm 3,4 \mu\text{mol m}^{-2} \text{s}^{-1}$
19:00-23:00 (4 h)	Red LED $51,4 \pm 2,9 \mu\text{mol m}^{-2} \text{s}^{-1}$	HPS $54,4 \pm 3,5 \mu\text{mol m}^{-2} \text{s}^{-1}$
23:00-07:00 (8 h)	Darkness	Darkness
Temperature °C	$20,06 \pm 1,12$	$20,06 \pm 1,12$
RH %	$70,34 \pm 4,6$	$70,89 \pm 3,87$
Red light ratio (above and below strawberry leaf)	$32 : 1,4 \pm 0,3 \mu\text{mol m}^{-2} \text{s}^{-1}$	

Every 24 h, at 18:00, the spore traps were changed in all four tunnels. The tape on each bottle was removed, placed in plastic boxes and stored in a fridge at 5 °C until counting of spores. The experiment was repeated 3 times. In the first repetition, cadavers stored in the freezer for up to 11 months were used, and in the next two repetitions freshly produced cadavers stored for two days in the fridge were used.

2.5.2 *Number of spores discharged from cadaver on microscope slides*

To study whether cadavers exposed directly to the different light quality regimes mentioned above were affected, the number of *N. floridana* spores discharges from mummified cadavers were measured. This was done by placing a cadaver with the dorsal side up on the center (M9-Ma and N9-Na) of a coverslip with grids (18x18 mm and a total of 520 squares: Photo-Etched Coverslip, Electron Microscopy Science) as described by Nilsen (2007). Cadavers on slides were then placed in a plastic box (22x16x7 cm) with moist filter paper and covered with a lid to ensure 100 % RH for sporulation (Figure 3). The cadavers mounted on slides were all given the same climatic conditions and light treatments as given for the tunnel experiment. The experiment was repeated with 19 cadavers for each light quality regime. In the first repetition, cadavers stored in the freezer were used, and in the next two repetitions freshly produced cadavers stored for a short time in the fridge were used.

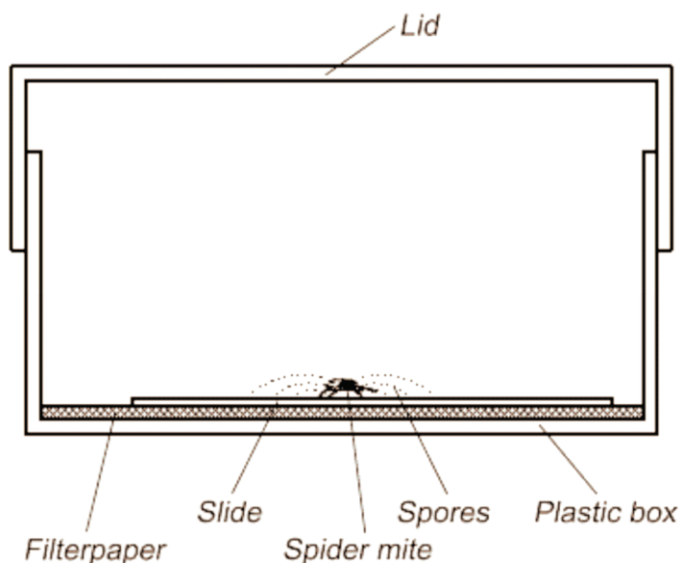

Figure 3. *T. urticae* cadaver with the dorsal side up mounted on a slide for sporulation in plastic box. Figure from (Nilsen, 2007).

2.6 Data registration

2.6.1 Counting spores from cadavers on whole plant experiment

The Melinex tape from the tunnel experiment was cut into six equal 4.9 cm pieces representing four hours on each piece of the 24 h cycle. Each piece of tape was held in place by a drop of glycerol on the microscope slides. Two drops of staining solution consisting of 0,075% Cotton Blue in 50% lactic acid were added on top of each piece of tape. A cover slip was then placed on top of this. The stained spores were counted under a phase contrast microscope (100 X) by moving the slide vertically for 2 mm (representing 10 min) in each reading, resulting in a total of 144 readings per day.

2.6.2 Counting spores from cadaver on slide experiment

To minimize the risk of spores drying up, counting of spores from the cadavers sporulating on slides was done continuously as the experiment was running. Numbers of spores in each of the 520 squares was counted under a phase contrast microscope (100X). The development stages of

the spores were registered either as primary conidia, germinating conidia or secondary conidia (capilla conidia).

2.7 *Statistic analysis*

2.7.1 *Number of spores from cadaver on whole plant experiment*

A statistical analysis was done in order to test whether different light quality had an effect on the total amount of spores discharged within each light regime. The total amount of spores discharged each day under each light treatment were added up and converted to their natural logarithmic equivalents. A General Regression Model ($P < 0.05$) was fitted (Minitab Inc, 2010). In the same procedure it was also tested whether the time aspect of when the discharge happened was a response to the different light treatments. Data from the red light treatment day one was left out of the analysis due to high Cook's distance numbers, making the influence of this one observation disproportionate compared to the rest of the data material (Appendix I).

2.7.2 *Number of spores form cadaver on slide experiment*

To compare the total number of spores discharged from each cadaver on slides under different light regimes an ANOVA General Linear Model (GLM) ($P < 0.05$) was used (Minitab Inc, 2010). The light treatment was the factor, while the amount of spores was set as the response. The categories of the conidial development were pooled to obtain a total number of conidia discharged. Slides with few spores discharged due to poor biological material were marked *. These observations were left out of the statistical test, a total of four observations from each light treatment, to avoid unnecessary noise of the data compared.

3 Results

3.1 Number of spores discharged from cadavers on whole plants

Results from the experiment with cadavers on whole plants revealed that light quality had an effect on the discharge pattern of *N. floridana* spores ejected from *T. urticae* cadavers. Cadavers on plants in the red light treatment discharged high numbers of spores over a longer period of time (6 days) than cadavers on plants in the white light treatment. Cadavers on plants in the red light treatment started to discharge spores at day 3 and ended at day 8. Cadavers on plants in the white light treatment discharged high numbers of spores over a shorter period of time (4 days), starting at day 2 and almost ending at day 5 (Figure 4). When the total number of spores discharged throughout the experiment is broken down to hourly discharge per day a clear difference in discharge pattern between the two different light treatments was seen (Figure 5 a-h). Spores discharged within the same light treatment follows the same discharge pattern but the pattern varies between the different light treatments. The general pattern for sporulation in the red light treatment starts at 21:00, two hours after the red light treatment is induced and ends at 06:00, one hour before the full light is introduced. The spore discharge peak is mainly reached within the red light hours (19:00-23:00). The general trend for sporulation under the white light treatment shows that spores are discharged only in the dark hours of the experiment (23:00-07:00). The peak is reached within the dark hours and with a sharp drop in discharge when full light is turned on (07:00), or an hour after it is turned on (08:00). Tunnel White 3 at Day 4 differ radically from the sporulation patter described above, however, by having two peaks and spores being discharged after commence of full light. For both light treatments there seems to be a general decline in discharge the last hours of the dark period, reaching a low discharge rate before 07:00 and then it completely stops by the start of full light (Appendix II).

Results from the experiment also showed that light quality had a significant effect on the total amount of *N. floridana* spores discharged from *T. urticae* cadavers ($P = 0.00$). Cadavers under red light treatment discharged a higher total number of more spores (49306) compared to the white light treatment (34010). The total number of spores discharged in the white light regime varied considerably between tunnels, however. Further, the difference between the spores discharged in red and white light treatment was time dependent ($P = 0.00$).

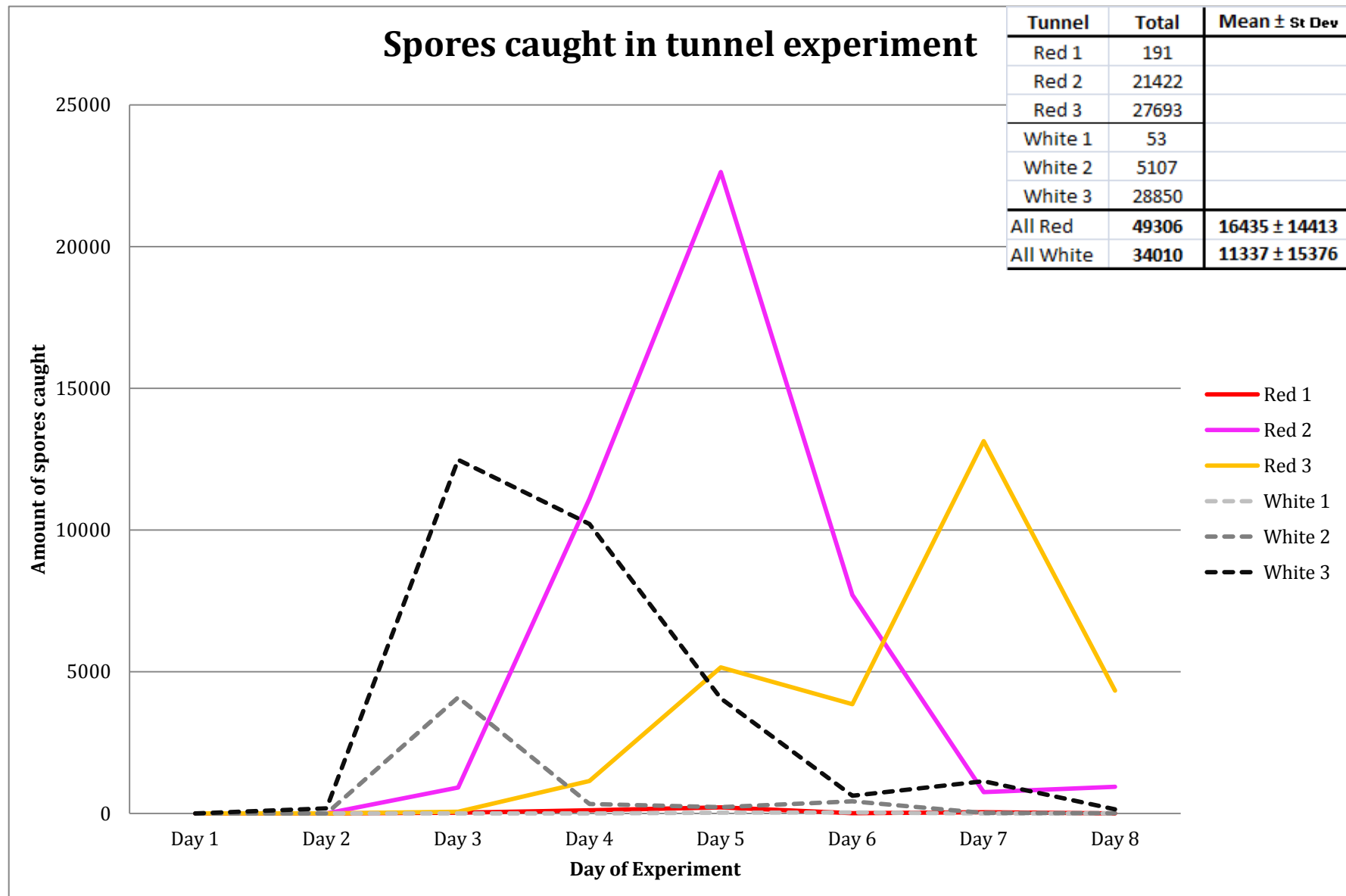
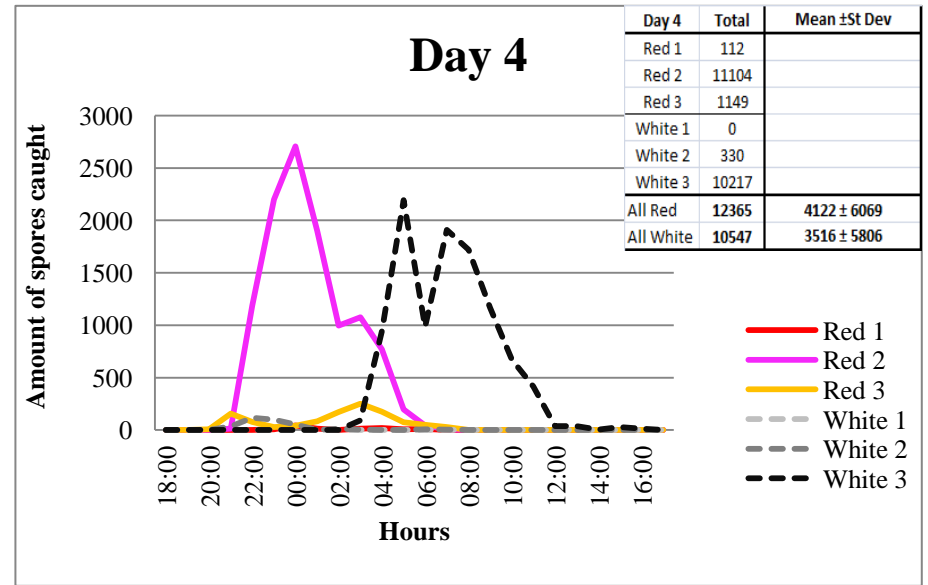
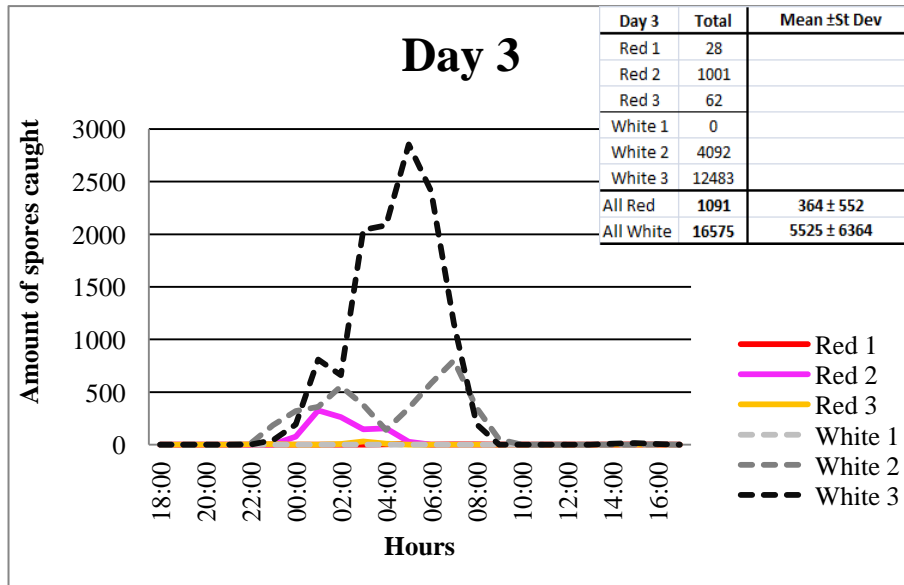
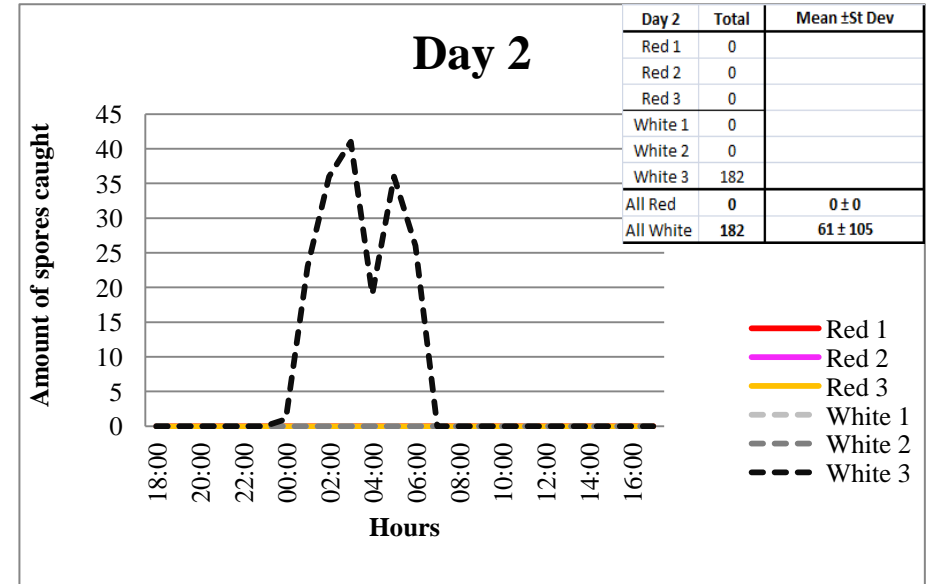
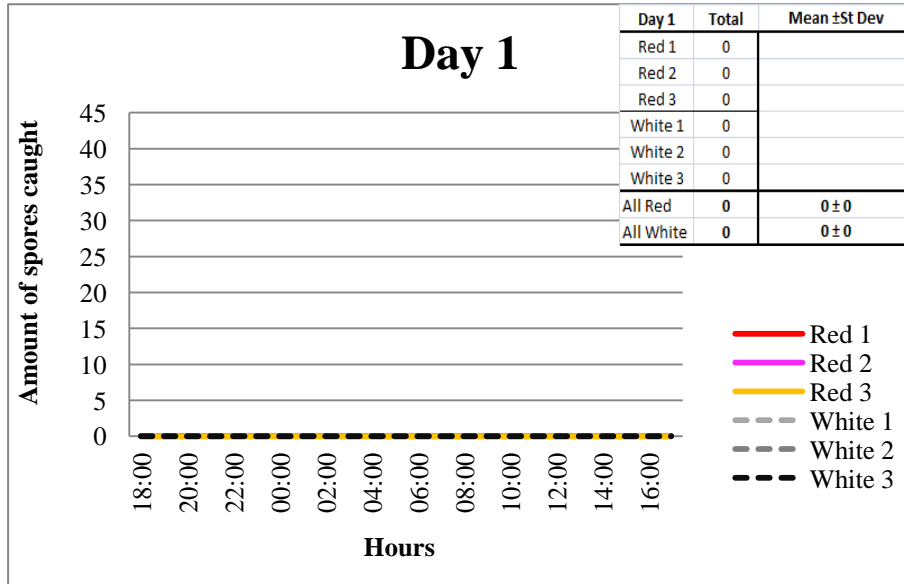

Figure 4. *Neozygites floridana* daily spore discharge from *N. floridana* killed *Tetranychus urticae* cadavers on strawberry plants exposed to two different light treatments (red and white as described in **Table 1**)

Results



Results

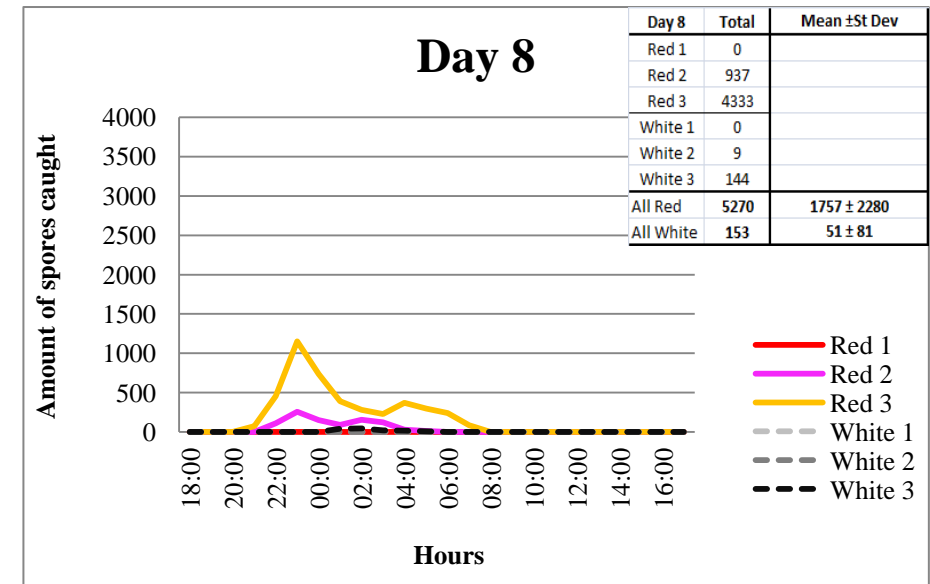
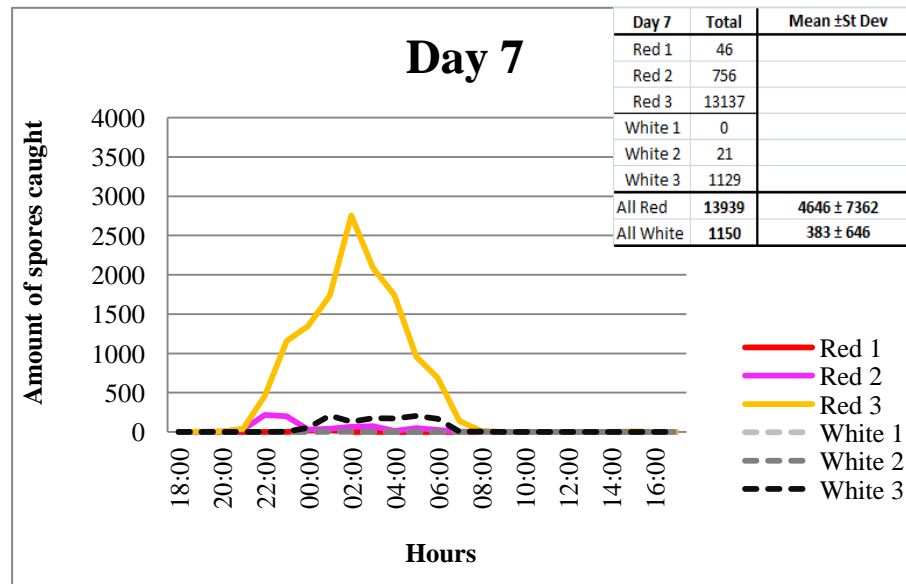
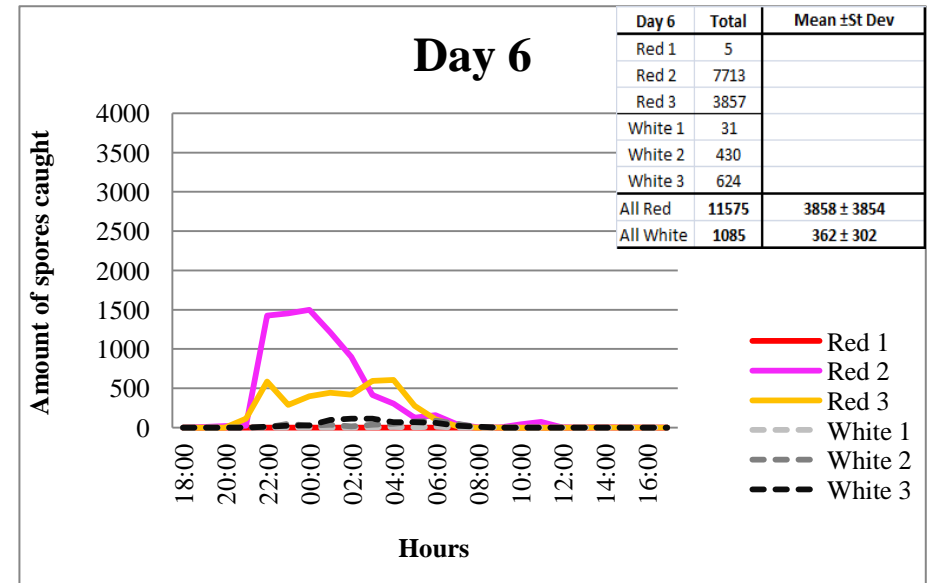
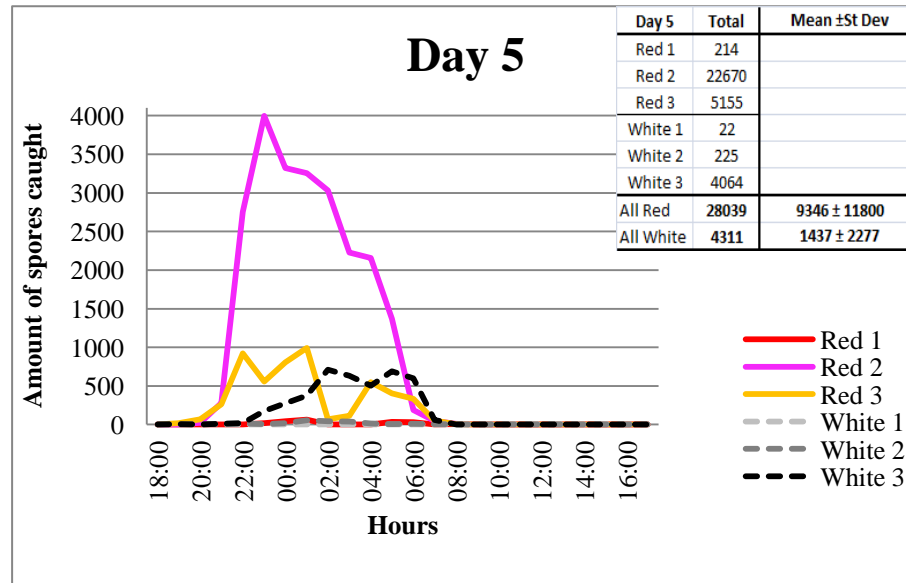

Figure 5 a-h. *Neozygites floridana* hourly spore discharge from *N. floridana* killed *Tetranychus urticae* cadavers on bean plants exposed to two different light treatments (red and white as described in **Table 1**). Note the varying y-axis values.

3.2 Numbers of spores discharged from cadavers on slides

There was no significant difference ($P = 0.256$) between the total amount of spores discharged when sporulating cadavers on a slide were directly exposed to the different light treatments (Table 2). The total number of spores varied considerably within each treatment, however, resulting in large standard deviations. The highest and lowest number of spores discharged under red light treatment was 6695 and 854, and under the white light treatment it was 7135 and 1617 (Appendix III).

Table 2. Mean numbers of *Neozygites floridana* spores discharged from *N. floridana* killed *Tetranychus urticae* cadavers exposed on slides directly to the different light treatments (red and white as described in Table 1). n=15.

Light Treatment	Number of spores (\pm StDev) ^a
1: Red light	3240 (\pm 2262) ^a
2: White light	4073 (\pm 1623) ^a

^aSame letters in column denotes no significant differences ($P < 0.05$) using ANOVA GLM.

4 Discussion

4.1 Number of spores discharged from cadavers on whole plants

No studies have, to my knowledge, previously been conducted on the effect of light (light:dark ratio, intensity/quantity or quality) on hourly and daily spore discharge of entomophthoralean fungi on a natural host in whole plant experiments under controlled climatic conditions. The use of tunnels with spore traps that catches spores released from *N. floridana* killed *T. urticae* cadavers on whole strawberry plants on an hourly basis is therefore a novel method and gives us new and interesting information. Our results showed that the red light treatment resulted in prolonged sporulation both in hours and days compared to the white light treatment. Red light seemed to stimulate sporulation within the red light hours and throughout the dark period, while in the white light treatment the spore discharge only starts in the dark period. Previous studies on the effect of the light:dark ratio and light intensity on sporulation of *N. floridana* from natural host cadaver show a higher sporulation in complete darkness and in 12 h:12 h light:dark regime compared to continuous light (Castro et al., 2010; Oduor et al., 1996). Castro et al. (2010) also showed no effect of the photoperiod (12 and 24 h) on spore discharge under dim light conditions ($40 \mu\text{mol m}^{-2} \text{s}^{-1}$). This supports my findings which show that spores are being discharged almost only during the reduced light intensity period between 19:00 and 23:00 (Red LED $51,4 \mu\text{mol m}^{-2} \text{s}^{-1}$ and White HPS $54,4 \mu\text{mol m}^{-2} \text{s}^{-1}$) and during the dark period between 23:00-07:00 for both the red and the white light treatments.

Older studies on the effects of light on sporulation by different entomophthoralean fungi have given variable responses, however (Callaghan, 1969; Ege, 1965; Wilding, 1971). Also *Entomophthora thaxteriana* (syn *Entomophthora obscura*) spores discharged from its natural host pea aphid (*Acyrtosiphon pisium*) per hour is much higher (2X) under continuous light for 48 h under 1250 Lux (corresponding to $17 \mu\text{mol m}^{-2} \text{s}^{-1}$) compared to complete darkness. Lux has been converted to $\mu\text{mol m}^{-2} \text{s}^{-1}$ by multiplying the Lux with the conversion factor for Cool White Fluorescent Lamps: 0.0135 (Apogee Instruments). Even though the total number of spores discharged under dark conditions was much lower compared to light conditions, the maximum discharge was maintained for 10 h while in the light treatment the maximum discharge soon declined after reaching its peak (Wilding, 1971). The effect of alternating photoperiods 12 h light:12 h dark for 48 h on the rate of spores discharged from *E. thaxteriana* under the same light intensity was also tested. Results show an increase in spore discharge 2 h after the admission of

light and the discharge lasted throughout the light period. In the preceding dark hours, the amount of spores discharged decreased by half 2 h after the exclusion of light. What Wilding call light in the experiments is of much lower intensity compared to what is called dimmed light in Castro et al. (2010) and my experiments, and could possibly support the results of sporulation during the reduced light hours and in the dark. Ege (1965) show that *Conidiobolus coronatus* (syn. *Entomophthora coronata*), *Conidiobolus obscures* (syn. *Entomophthora virulent*) and one other *Entomophthora* species (presumably *Entomophthora planchoniana*) grown on Pepton-Glucose-Agar discharges up to 10 times as many conidia in light than in dark when directly exposed to a light source of 6500 Lux ($87 \mu\text{mol m}^{-2} \text{s}^{-1}$) for 60 h. In darkness the lowest number of spores was produced for all three species. Callaghan (1969) tested spore discharge from Petri dish cultures of *C. coronatus* (syn: *E. coronata*) and the frog pathogen *Basidiobolus ranarum* in light (1350 Lux = $18 \mu\text{mol m}^{-2} \text{s}^{-1}$ and 1700 Lux = $23 \mu\text{mol m}^{-2} \text{s}^{-1}$, respectively) and in complete darkness for seven days. *C. coronatus* produced a higher amount of spores under light conditions. The results from Ege and Callaghan's studies could indicate that these entomophthoralean species throw spores under other conditions than *N. floridana*. The low light intensities, direct and continuous light exposure over a long period of time, makes our results, however, difficult to compare. Also, the light quality used is not known and hence it could be a light source with a lot of red light in it that might induce spore discharge. For conidia discharge in *B. ranarum* light had a more marked effect compared to *C. coronatus*, with the vast majority of spores discharged under light conditions. Callaghan also showed periodicity of spore discharge when cultures of *C. coronatus* and *B. ranarum* got exposed to alternating 12:12 h of light (900 Lux = $12 \mu\text{mol m}^{-2} \text{s}^{-1}$) and darkness over 8-10 days. Spore discharge was increased for both cultures during the light exposure hours and declined during the dark periods.

My study also shows that the spore discharge peak is mainly reached within the red light hours (19:00-23:00) and that a sharp drop in conidial release follows when the full light is turned on at 07:00. Ege (1965) also showed that different light qualities might result in different amounts of spores discharged from different species within the order Entomophthorales. In red light treatment (580-720 nm, 1000 Lux = $13.5 \mu\text{mol m}^{-2} \text{s}^{-1}$) *C. coronatus* produced the largest amount of spores (dry weight in mg) compared to the orange, green and blue light treatments, while the two other cultures produced the lowest amount of spores in red light treatment. *C. coronatus* and *E. planchoniana* produced equal amount of spores in orange (530-670 nm, 3800 Lux = $51.3 \mu\text{mol m}^{-2} \text{s}^{-1}$) and green (525 nm, 700 Lux = $9.45 \mu\text{mol m}^{-2} \text{s}^{-1}$) light, while more spores were produced in blue light (700 nm, 700 Lux = $9.45 \mu\text{mol m}^{-2} \text{s}^{-1}$). Experiments conducted by Callaghan (1969)

also demonstrate an equally low response in spore discharge from *B. ranarum* under red light (630 nm) and darkness, compared to blue (440 nm and 480 nm) and green (540 nm) light, all intensities set to 100 Lux ($1.4 \mu\text{mol m}^{-2} \text{s}^{-1}$). The light intensities used in the in Ege and Callaghan's studies are again much lower compared to the intensity of the dimmed light (red and white) used in the tunnel experiment. The expectation is the intensity of the orange light in Ege's study, which can be compared to the intensity used for the dimmed light hours. Some of the intensities almost resemble darkness, making the interesting results also here difficult to compare to the results obtained from the tunnel experiment. Even if the intensities used in Ege and Callaghan's studies varied within and between the experiments, their findings showed how different light qualities affect spore production and discharge of different Entomophthorales. This could also be true for *N. floridana* and further studies on the effect of different light quality will reveal new information which might expand the use of *N. floridana* in biological control.

Even though a very variable total amount of spores are produced in the different tunnels in the white light treatment, the prolonged spore discharge period for red light (6 Days) compared to white light (4 Days) might lead to a higher sporulation. During dusk and dawn you find a higher rate of red light (Corfidi, 2012) and based on my findings it might be suggested that sporulation might increase in environments where *N. floridana* indirectly, through the plant and its host (*T. urticae*), is exposed to red light conditions. My results from the dimmed light period ($51,4 \pm 2,9 \mu\text{mol m}^{-2} \text{s}^{-1}$) in the red light treatment indicates that sporulation may occur in the dim evening and morning hours in the tropics and during the dim summer nights in temperate regions. Wilding (1970) propose that together with humid air, the influence of light at sunrise resulted in a peak in five different Entomophthora spp spores caught in spore traps at 06:00 hr in a park in Berkshire, UK. I therefore suggest that in glasshouse productions the addition of red light might increase and prolong the sporulation of *N. floridana* and hence increase the efficacy of *N. floridana* as a control agent against *T. urticae*.

T. urticae live and feed on the underside of the leaf due to sensitivity against UV light (Sakai & Osakabe, 2010; Suzuki et al., 2009; Tomczyk & Kropczynska, 1985) and the sporulating cadavers are observed in the same location. Underneath the leaf's surface virtually none of the red light emitted from the LED lamps will have a direct exposure effect on the living *T. urticae* nor the cadavers (see Table 1 for comparison between red light intensity emitted above and below strawberry leaf surface) since the leaf will absorb the red waves through the photoreceptors and phytochromes Pr and Pfr located on the surface (Hopkins & Huner, 2009). Plants are affected by

different light intensities, qualities and durations and this may alter the plant in many ways (Sonsteby & Heide, 2006; Verheul et al., 2006; Verheul et al., 2007). Further, it is known that plants directly or indirectly (through the insect/mite host) affect fungal entomopathogens (Cory & Ericsson, 2010; Hajek & Stleger, 1994). Wekesa et al. (2011) showed that strawberry and jack beans resulted in an increased conidia production and an overall greater performance of *N. floridana* compared to other *T. urticae* host plants such as cotton and *Gerbera*.

Herbivore-induced plant volatiles (HIPV) are released from attacked plants in order to draw predators and/or parasitoids to the pest. It is proved that when strawberries are fed upon by *T. urticae* HIPV are released in order to attract the predatory mite *Phytoseiulus macropilis* (Fadini et al., 2010). A few recent studies have tried to locate a connection between HIPV and sporulation of *Neozygites* from host cadavers. Hountondji et al. (2005) suggest that plant volatiles suppress germination of *N. tanajoae* in the absence of the herbivore mite *Mononychellus tanajoa*. As mites started to feed on the cassava plant, plant volatiles emitted from herbivory triggered sporulation from previous developed cadavers. It is proposed that cadavers may adsorb the increased emitted volatiles and thereby induced the release of *N. tanajoae* conidia (Hountondji et al., 2006).

For sporulation of *N. floridana* from *T. urticae* cadavers the abiotic conditions of RH >90% and temperatures of 15-26°C must be present, where RH is a more important factor than temperature (Carner, 1976; Kennedy & Smitley, 1988; Oduor et al., 1996; Smitley et al., 1986). Due to the prolonged sporulation under red light treatment it is tempting to propose that red light can have a physiological effect on the plant that alters the abiotic factors in the plants microclimate, making the conditions optimal for sporulation. Studies have shown how red light can reset the circadian rhythm in plants (Sonsteby, pers. comm., 2012) which might have influenced the time of spore discharge in the red light treatment.

4.2 Numbers of spores discharged from cadavers on slide

In this study direct exposure of cadavers on slides to the different light regimes (red and white) did not have an effect on the total amount of spores discharged. It would have been interesting, however, to study whether the effect of direct light exposure from the different light regimes also resulted in hourly difference in spore discharge during a 24 h cycle as shown for the whole plant experiment. As there are no data for hourly discharge in the slide experiment the results on

light:dark ratio for *N. floridana* sporulation from the previously mentioned Castro et al. (2010) and Oduor et al. (1996) should also be considered here.

4.3 Outlook

The aim of this study was to gather new knowledge on the response of *N. floridana* to different light quality regimes for the potential use of *N. floridana* as a biocontrol agent against *T. urticae*. With the increased focus on IPM and the negative non-target effects of pesticides biocontrol is an interesting alternative pest control strategy in agricultural production systems. Regardless of the positive and sustainable approach of using biological control, in order for farmers to use biological control strategies to control pest populations, the cost and effect from the use must be equal or better than the (short-term) benefits from using insecticides. Biological control has proven to be effective in Norwegian glass house vegetable production as over 67 % of all producers use biological control to control pests (Statistisk sentralbyrå, 2010). As previously mentioned, *T. urticae* quickly develop resistance towards insecticides. The potential for resistance development should be kept in mind even when controlling insect pest population through the use of biocontrol. How likely for this issue to occur is not certain as the pathogenic fungi and the herbivore will continue their co-evolution, adapting to each other through time.

It is important to reflect around the question “Why has *T. urticae* become a pest?” when trying to solve the pest problem. Have we pushed the genetics of strawberries and the production system too far that it backfires with high infestation rate of pests? Monoculture production systems with widespread use of chemical pesticides will increase pest invasions as the limited biodiversity will not favor natural enemies to regulate the pest populations (Brandenburg & Kennedy, 1987; Klingen & Westrum, 2007; Prischmann et al., 2005). By implementing different biocontrol strategies to manage *T. urticae* population in monoculture productions we only prolong the unsustainable production system through patching up punctures in a system with holes. Maybe a redesign of the production methods, making it less dependent on chemical inputs, should have a stronger focus and not just methods to fix the wrong. A redesign will have its cost as there are biological and ecological restrictions on how far a system can be changed and still be able to produce strawberries to an affordable price. Have we gotten used to too cheap strawberries at the cost of produce quality with pesticide residues and negative effects on the biological system?

5 Conclusion

The two experiments in controlled climatic chambers revealed new knowledge on the response of *N. floridana* to different light quality regimes. In the whole plant experiment *N. floridana* showed a prolonged sporulation from its host *T. urticae* both in hours and days under red light treatment. White light treatment sporulation started only during the hours of darkness, which corresponds to previous findings. Direct light exposure in the slide experiment showed no difference in the total amount of spores discharged between the two light regimes. The results from these studies strengthen the theory that red light affects *N. floridana* sporulation indirectly through multitrophic interactions between the plant (strawberry), the herbivore (*T. urticae*) and the beneficial fungus (*N. floridana*). To reveal the mechanisms involved further studies are needed. If red light increases *N. floridana* performance, adding *N. floridana* and red light to control *T. urticae* in glasshouses might be an idea.

6 References

- Aarstad, P. A., Bjørlo, B. & Gundersen, G. I. (2009). Bruk av plantevernmidler i jordbruket i 2008., 2009/52: Statistisk sentralbyrå. 102 pp.
- Altieri, M. A. (1999). The ecological role of biodiversity in agroecosystems. *Agriculture Ecosystems & Environment*, 74 (1-3): 19-31.
- Apogee Instruments. *Conversions-PPF to Lux*. Frequently Asked Questions: Apogee Instruments, Inc. Available at: <http://www.apogeeinstruments.com/conversions/lux-ppf.html> (accessed: 05.04.2012).
- BiPRO. (2009). Development of guidance for establishing Integrated Pest Management (IPM) principles. *07.0307/2008/504015/ETU/B3*. Brussels: European Commission.
- Brandenburg, R. L. & Kennedy, G. G. (1987). Ecological and Agricultural Considerations in the Management of Twospotted Spider Mite (*Tetranychus urticae* Koch). *Agricultural Zoology Reviews*, 2: 185-236.
- Callaghan, A. A. (1969). Light and Spore Discharge in Entomophthorales. *Transactions of the British Mycological Society*, 53: 87-97.
- Carner, G. R. (1976). Description of Life Cycle of Entomophthora sp. in the Two-Spotted Spider Mite. *Journal of Invertebrate Pathology*, 28 (2): 245-254.
- Castro, T. R., Wekesa, V. W., Delalibera, I. & Klingen, I. (2010). *Effect of photoperiod and light intensity on sporulation and germination of Neozygites floridana (Entomophthorales: Neozygitaceae) isolates from Brazil and Norway*. XIII International Congress of Acarology, Recife-PE, Brazil.
- Corfidi, S. F. (2012). *The Colors of Sunset and Twilight*: NOAA/NWS Storm Prediction Center. Available at: <http://www.spc.noaa.gov/publications/corfidi/sunset/> (accessed: 27.04.2012).
- Cory, J. S. & Ericsson, J. D. (2010). Fungal entomopathogens in a tritrophic context. *Biocontrol*, 55 (1): 75-88.
- Cross, J. V., Easterbrook, M. A., Crook, A. M., Crook, D., Fitz Gerald, J. D., Innocenzi, P. J., Jay, C. N. & Solomon, M. G. (2001). Review: Natural enemies and biocontrol of pests of strawberry in northern and central Europe. *Biocontrol Science and Technology*, 11 (2): 165-216.
- De Schutter, O. (2010). Report submitted by the Special Rapporteur on the right to food, Olivier De Schutter. *Agenda item 3: Promotion and protection of all human rights, civil, political, economic, social and cultural rights, including the right to develop.*: United Nations. 21 pp.
- DeBach, P. & Rosen, D. (1991). *Biological control by natural enemies*. 2 ed. Cambridge: Cambridge University Press. xiv, 440 s. pp.
- Dent, D. (1995). *Integrated Pest Management*. 1 ed. London, UK: Chapman & Hall.
- Ege, O. (1965). Ein Beitrag zur Biologie einiger aphidivorer Entomophthoraceen. *Archiv Fur Mikrobiologie*, 52 (1): 20-48.
- Eilenberg, J., Hajek, A. & Lomer, C. (2001). Suggestions for unifying the terminology in biological control. *Biocontrol*, 46 (4): 387-400.
- Fadini, M. A. M., Venzon, M., Oliveira, H., Pallini, A. & Vilela, E. F. (2010). Response of the Predatory Mite *Phytoseiulus macropilis* (Banks) to Volatiles Produced by Strawberry Plants in Response to Attack by Tetranychid Mites (Acari: Phytoseiidae: Tetranychidae). *Neotropical Entomology*, 39 (2): 248-252.
- FAO. (1967). Report of the first session of the FAO Panel of Experts on Integrated Pest Control. Rome, Italy: Food and Agricultural Organization of the United Nations. 19 pp.
- Francis, C., Lieblein, G., Gliessman, S., Breland, T. A., Creamer, N., Harwood, R., Salomonsson, L., Helenius, J., Rickerl, D., Salvador, R., et al. (2003). Agroecology: The ecology of food systems. *Journal of Sustainable Agriculture*, 22 (3): 99-118.

References

- Gliessmann, S. R. (2004). Agroecology and Agroecosystems. In Rickerl, D. & Francis, C. (eds) vol. 43 *Agroecosystems Analysis*, pp. 19-29. Wisconsin, USA: American Society of Agronomy, Inc., Crop Science of America, Inc., Soil Science of America, Inc.
- Gliessmann, S. R. (2007). *Agroecology: The Ecology of Sustainable Food Systems*. 2nd ed. Florida: CRC Press.
- Gomiero, T., Pimentel, D. & Paoletti, M. G. (2011). Is There a Need for a More Sustainable Agriculture? *Critical Reviews in Plant Sciences*, 30: 6-23.
- Hajek, A. E. & Stleger, R. J. (1994). Interactions Between Fungal Pathogens and Insect Hosts. *Annual Review of Entomology*, 39: 293-322.
- Hofsvang, T. (2010). Integrert plantevern. *Bioforsk TEMA* (12): 1-12.
- Hopkins, W. G. & Huner, N. P. A. (2009). Photomorphogenesis: Responding to Light. In *Introduction to Plant Physiology*, pp. 373-389: John Wiley & Sons, Inc.
- Hountondji, F. C. C., Sabelis, M. W., Hanna, R. & Janssen, A. (2005). Herbivore-induced plant volatiles trigger sporulation in entomopathogenic fungi: The case of *Neozygites tanajoae* infecting the cassava green mite. *Journal of Chemical Ecology*, 31 (5): 1003-1021.
- Hountondji, F. C. C., Hanna, R. & Sabelis, M. W. (2006). Does methyl salicylate, a component of herbivore-induced plant odour, promote sporulation of the mite-pathogenic fungus *Neozygites tanajoae*? *Experimental and Applied Acarology*, 39 (1): 63-74.
- IAASTD. (2009). Synthesis Report: A Synthesis of the Global and Sub-Global IAASTD Reports. In McIntyre, B., Herren, H. R., Wakhungu, J. & Watson, R. T. (eds). New York, USA: International Assessment of Agricultural Knowledge, Science and Technology for Development. 106 pp.
- Kennedy, G. G. & Smitley, D. R. (1988). *Method of controlling plant feeding mites with the fungus Neozygites floridana*. USA. United States Patent 4752468.
- Klingen, I. & Westrum, K. (2007). The effect of pesticides used in strawberries on the phytophagous mite *Tetranychus urticae* (Acari: Tetranychidae) and its fungal natural enemy *Neozygites floridana* (Zygomycetes: Entomophthorales). *Biological Control*, 43: 222-230.
- Landbruks- og matdepartementet. (2009). *Handlingsplan for redusert risiko ved bruk av plantevernmidler (2010-2014)*. Oslo: Landbruks- og matdepartementet,. 12 pp.
- Lewis, W. J., vanLenteren, J. C., Phatak, S. C. & Tumlinson, J. H. (1997). A total system approach to sustainable pest management. *Proceedings of the National Academy of Sciences of the United States of America*, 94 (23): 12243-12248.
- Minitab Inc. (2010). *Minitab 16.1.1*. Enterprise drive, State College, PA, USA.
- Nielsen, C. (2002). *Interactions Between Aphids and Entomophthoralean Fungi*. Ph.D. Thesis. Copenhagen, Denmark: The Royal Veterinary and Agricultural University, Department of Ecology. 62 pp.
- Nilsen, S. S. (2007). *Effect of Temperature on Neozygites floridana Sporulation and the Within-Cucumber Plant Distribution of Infected and Healthy Tetranychus urticae*. Master Thesis. Ås: Norwegian University of Life Science, Department of Ecology and Natural Resource Management. 64 pp.
- Oduor, G. I., DeMoraes, G. J., VanderGeest, L. P. S. & Yaninek, J. S. (1996). Production and germination of primary conidia of *Neozygites floridana* (Zygomycetes: Entomophthorales) under constant temperatures, humidities, and photoperiods. *Journal of Invertebrate Pathology*, 68 (3): 213-222.
- Oerke, E. C. & Dehne, H. W. (1997). Global crop production and the efficacy of crop protection - Current situation and future trends. *European Journal of Plant Pathology*, 103 (3): 203-215.
- Oerke, E. C. & Dehne, H. W. (2004). Safeguarding production - losses in major crops and the role of crop protection. *Crop Protection*, 23 (4): 275-285.

- Pell, J. K., Eilenberg, J., Hajek, A. E. & Steinkraus, D. C. (2001). Biology, Ecology and Pest Management Potential of Entomophthorales. In Butt, T. M., Jackson, C. & Magan, N. (eds) *Fungi as Biocontrol Agents*: CAB International.
- Pimentel, D., Acquay, H., Biltonen, M., Rice, P., Silva, M., Nelson, J., Lipner, V., Giordano, S., Horowitz, A. & Damore, M. (1992). Environmental and Economic Costs of Pesticide Use. *Bioscience*, 42 (10): 750-760.
- Prischmann, D. A., James, D. G., Wright, L. C., Teneyck, R. D. & Snyder, W. E. (2005). Effects of chlorpyrifos and sulfur on spider mites (Acari : Tetranychidae) and their natural enemies. *Biological Control*, 33 (3): 324-334.
- Sakai, Y. & Osakabe, M. (2010). Spectrum-specific Damage and Solar Ultraviolet Radiation Avoidance in the Two-spotted Spider Mite. *Photochemistry and Photobiology*, 86 (4): 925-932.
- Sastrapradja, S. (1988). Ecology of Agroecosystems in Relation to Natural Ecosystems. In Knutson, L. & Stoner, A. K. (eds) vol. 13 *Beltsville Symposia in Agricultural Research*, pp. 63-77: Beltsville Symposia.
- Sato, M. E., Da Silva, M. Z., De Souza, M. F., Matioli, A. L. & Raga, A. (2007). Management of *Tetranychus urticae* (Acari : Tetranychidae) in strawberry fields with *Neoseiulus californicus* (Acari : Phytoseiidae) and acaricides. *Experimental and Applied Acarology*, 42 (2): 107-120.
- Skretteberg, L. G., Holen, B., Kvarme, M. L. & Lyrån, B. (2011). Rester av plantevernmidler i næringsmidler 2010: Bioforsk & Mattilsynet. 101 pp.
- Smitley, D. R., Brooks, W. M. & Kennedy, G. G. (1986). Environmental Effects on Production of Primary and Secondary Conidia, Infection, and Pathogenesis of *Neozygites floridana*, a Pathogen of the Twospotted Spider Mite, *Tetranychus urticae*. *Journal of Invertebrate Pathology*, 47 (3): 325-332.
- Sonsteby, A. & Heide, O. M. (2006). Dormancy relations and flowering of the strawberry cultivars Korona and Elsanta as influenced by photoperiod and temperature. *Scientia Horticulturae*, 110 (1): 57-67.
- Statistisk sentralbyrå. (2010). *Tabell 1: Bruk av biologiske plantevernmidler i veksthus i 2008*. Bruk av plantevernmidler i veksthus, 2008 - Betydlig omfang av biologisk plantevern: Statistisk sentralbyrå.
- Statistisk sentralbyrå. (2011). *Tabell 343: Avling i hagebruket, Tonn*. Statistisk årbok 2011: Statistisk sentralbyrå.
- Suthaparan, A., Stensvand, A., Torre, S., Herrero, M. L., Pettersen, R. I., Gadoury, D. M. & Gislerod, H. R. (2010a). Continuous Lighting Reduces Conidial Production and Germinability in the Rose Powdery Mildew Pathosystem. *Plant Disease*, 94 (3): 339-344.
- Suthaparan, A., Torre, S., Stensvand, A., Herrero, M. L., Pettersen, R. I., Gadoury, D. M. & Gislerod, H. R. (2010b). Specific Light-Emitting Diodes Can Suppress Sporulation of *Podosphaera pannosa* on Greenhouse Roses. *Plant Disease*, 94 (9): 1105-1110.
- Suzuki, T., Watanabe, M. & Takeda, M. (2009). UV tolerance in the two-spotted spider mite, *Tetranychus urticae*. *Journal of Insect Physiology*, 55 (7): 649-654.
- Tanada, Y. & Kaya, H. (1993). Fungal Infections. In *Insect Pathology*. California, USA: Academic Press, Inc.
- Tomczyk, A. & Kropczynska, D. (1985). Effect on the Host Plant. In Sabelis, M. W. & Helle, W. (eds) vol. 1A *Spider mites: their biology, natural enemies and control*. Amsterdam: Elsevier.
- Verheul, M. J., Sonsteby, A. & Grimstad, S. O. (2006). Interactions of photoperiod, temperature, duration of short-day treatment and plant age on flowering of *Fragaria x ananassa* Duch. cv. Korona. *Scientia Horticulturae*, 107 (2): 164-170.

References

- Verheul, M. J., Sonstebj, A. & Grimstad, S. O. (2007). Influences of day and night temperatures on flowering of *Fragaria x ananassa* Duch., cvs. Korona and Elsanta, at different photoperiods. *Scientia Horticulturae*, 112 (2): 200-206.
- Wekesa, V. W., Knapp, M. & Delalibera, I. (2008). Side-effects of pesticides on the life cycle of the mite pathogenic fungus *Neozygites floridana*. *Experimental and Applied Acarology*, 46 (1-4): 287-297.
- Wekesa, V. W., Vital, S., Silva, R. A., Ortega, E. M. M., Klingen, I. & Delalibera, I. (2011). The effect of host plants on *Tetranychus evansi*, *Tetranychus urticae* (Acari: Tetranychidae) and on their fungal pathogen *Neozygites floridana* (Entomophthorales: Neozygitaceae). *Journal of Invertebrate Pathology*, 107 (2): 139-145.
- Wilding, N. (1970). Entomophthora Conidia in Air-spora. *Journal of General Microbiology*, 62 (AUG): 149-157.
- Wilding, N. (1971). Discharge of Conidia of *Entomophthora thaxteriana* Petch from the Pea Aphid *Acyrtosiphon pisum* Harris *Journal of General Microbiology*, 69 (DEC): 417-422.
- Wilson, C. & Tisdell, C. (2001). Why farmers continue to use pesticides despite environmental, health and sustainability costs. *Ecological Economics*, 39 (3): 449-462.

7 Appendix

Appendix I: Fitted General Regression Model with and without the observed data from the red tunnels day one.

Appendix II: Number of *Neozygites floridana* spores discharged from *N. floridana* killed *Tetranychus urticae* cadavers on whole plants under the different light treatments.

Appendix III: Numbers of *Neozygites floridana* spores discharged from *N. floridana* killed *Tetranychus urticae* cadavers on slides under the different light treatments.

Appendix I

Fitted General Regression Model with and without the observed data from the red tunnels day one.

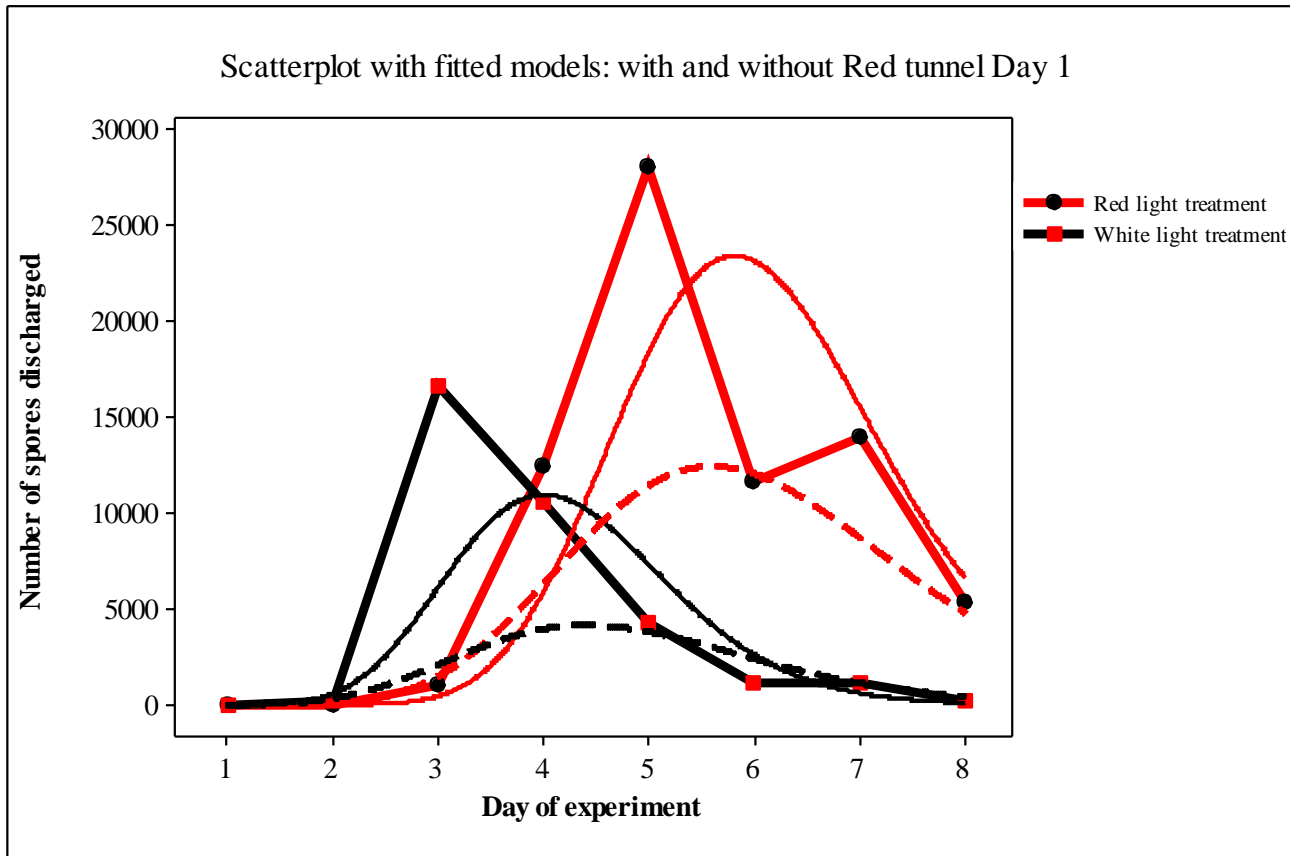

Bold lines: amount of spores discharged from Red and White tunnel every day.

Thin solid line: fitted model for Red and White tunnels without Red tunnel Day 1.

Dotted line: fitted model for Red and White tunnels with Red tunnel Day 1.

Appendix II

Number of Neozygites floridana spores discharged from N. floridana killed Tetranychus urticae cadavers on whole plants under the different light treatments (white and red as described in Table 1)

Hours	HPS 150 $\mu\text{mol m}^{-2} \text{s}^{-1}$	Red/White 50 $\mu\text{mol m}^{-2} \text{s}^{-1}$				Darkness								HPS 150 $\mu\text{mol m}^{-2} \text{s}^{-1}$										Total			
	18	19	20	21	22	23	00	01	02	03	04	05	06	07	08	09	10	11	12	13	14	15	16		17		
Day 1																											
R1	0	0	0	0	0	0	0	0	0	0	0	0	0	0	0	0	0	0	0	0	0	0	0	0	0	0	0
R2	0	0	0	0	0	0	0	0	0	0	0	0	0	0	0	0	0	0	0	0	0	0	0	0	0	0	0
R3	0	0	0	0	0	0	0	0	0	0	0	0	0	0	0	0	0	0	0	0	0	0	0	0	0	0	0
W1	0	0	0	0	0	0	0	0	0	0	0	0	0	0	0	0	0	0	0	0	0	0	0	0	0	0	0
W2	0	0	0	0	0	0	0	0	0	0	0	0	0	0	0	0	0	0	0	0	0	0	0	0	0	0	0
W3	0	0	0	0	0	0	0	0	0	0	0	0	0	0	0	0	0	0	0	0	0	0	0	0	0	0	0
Day 2																											
R1	0	0	0	0	0	0	0	0	0	0	0	0	0	0	0	0	0	0	0	0	0	0	0	0	0	0	0
R2	0	0	0	0	0	0	0	0	0	0	0	0	0	0	0	0	0	0	0	0	0	0	0	0	0	0	0
R3	0	0	0	0	0	0	0	0	0	0	0	0	0	0	0	0	0	0	0	0	0	0	0	0	0	0	0
W1	0	0	0	0	0	0	0	0	0	0	0	0	0	0	0	0	0	0	0	0	0	0	0	0	0	0	0
W2	0	0	0	0	0	0	0	0	0	0	0	0	0	0	0	0	0	0	0	0	0	0	0	0	0	0	0
W3	0	0	0	0	0	0	1	23	36	41	19	36	26	0	0	0	0	0	0	0	0	0	0	0	0	0	182

Appendix

Day 3																								
R1	0	0	0	0	0	0	0	0	0	5	9	1	4	4	1	0	0	0	0	0	4	0	0	28
R2	0	0	0	0	3	76	327	263	148	155	29	0	0	0	0	0	0	0	0	0	0	0	0	1001
R3	0	0	0	4	6	1	0	6	31	11	0	0	1	2	0	0	0	0	0	0	0	0	0	62
W1	0	0	0	0	0	0	0	0	0	0	0	0	0	0	0	0	0	0	0	0	0	0	0	0
W2	0	0	0	10	187	320	360	555	377	142	347	586	800	351	52	0	0	0	0	1	0	3	1	4092
W3	0	0	0	1	43	192	811	660	2042	2085	2854	2411	1152	196	0	0	2	0	0	9	17	6	2	12483

Day 4																								
R1	0	0	0	0	8	43	13	0	13	19	7	9	0	0	0	0	0	0	0	0	0	0	0	112
R2	0	1	0	13	2201	2708	1902	998	1077	770	197	44	6	0	0	0	0	0	0	0	0	0	0	11104
R3	2	2	7	156	27	40	84	172	251	174	74	51	28	1	0	0	0	0	0	2	0	0	0	1149
W1	0	0	0	0	0	0	0	0	0	0	0	0	0	0	0	0	0	0	0	0	0	0	0	0
W2	0	0	0	35	97	53	2	13	3	0	0	6	4	0	0	0	0	0	0	0	0	0	0	330
W3	0	0	0	1	0	0	0	0	93	941	2193	983	1910	1721	1167	672	417	38	37	3	27	14	0	10217

Day 5																								
R1	0	0	0	3	18	42	65	3	3	0	36	32	4	8	0	0	0	0	0	0	0	0	0	214
R2	0	0	21	281	3999	3321	3255	3031	2229	2158	1371	190	48	10	0	0	0	0	0	0	0	0	0	22670
R3	0	18	67	263	559	804	993	67	114	551	403	335	50	8	0	0	0	0	0	0	0	0	0	5155
W1	0	0	0	0	0	0	0	0	0	0	0	0	0	0	0	0	5	5	5	0	6	1	0	22
W2	0	0	0	9	5	18	57	43	38	13	7	11	7	4	0	0	0	0	0	0	0	0	0	225
W3	0	5	4	12	176	276	373	712	631	503	690	599	60	3	0	0	0	0	0	0	0	0	0	4064

Appendix

Day 6																							
R1	0	1	0	0	0	0	0	0	0	0	0	0	0	0	0	0	0	1	3	0	0	0	5
R2	0	6	20	25	1424	1455	1497	1214	901	416	305	125	159	45	4	0	40	72	5	0	0	0	7713
R3	0	0	1	114	585	290	400	445	418	595	607	275	106	21	0	0	0	0	0	0	0	0	3857
W1	0	1	0	0	0	0	0	0	1	2	9	4	12	0	0	0	1	0	0	0	0	0	31
W2	0	0	0	0	2	49	25	38	14	36	47	75	90	48	6	0	0	0	0	0	0	0	430
W3	0	0	0	0	12	24	30	98	113	113	69	68	61	25	10	0	0	0	0	0	1	0	624

Day 7																							
R1	0	0	1	0	1	2	19	22	0	0	0	0	0	0	0	0	0	1	0	0	0	0	46
R2	0	0	3	34	216	201	30	42	67	75	12	49	24	3	0	0	0	0	0	0	0	0	756
R3	0	3	3	40	460	1158	1347	1736	2754	2085	1740	959	690	140	12	0	0	0	0	0	9	0	13137
W1	0	0	0	0	0	0	0	0	0	0	0	0	0	0	0	0	0	0	0	0	0	0	0
W2	0	0	0	0	0	0	2	3	10	0	0	0	2	1	3	0	0	0	0	0	0	0	21
W3	0	0	2	0	1	7	54	207	132	177	171	204	166	5	3	0	0	0	0	0	0	0	1129

Day 8																							
R1	0	0	0	0	0	0	0	0	0	0	0	0	0	0	0	0	0	0	0	0	0	0	0
R2	0	0	0	0	110	257	151	92	158	124	30	15	0	0	0	0	0	0	0	0	0	0	937
R3	1	3	3	75	457	1152	739	390	284	229	373	297	240	87	2	0	0	0	0	0	1	0	4333
W1	0	0	0	0	0	0	0	0	0	0	0	0	0	0	0	0	0	0	0	0	0	0	0
W2	0	0	0	0	1	1	0	1	0	1	1	1	0	3	0	0	0	0	0	0	0	0	9
W3	0	0	0	0	0	0	3	41	45	21	19	11	2	1	1	0	0	0	0	0	0	0	144

Appendix III

Numbers of Neozygites floridana spores discharged from N. floridana killed Tetranychus urticae cadavers on slides under the different light treatments (white and red as described in Table 1)

Mite no	Total number of spores discharged pr cadaver	
	1: Red light treatment	2: White light treatment
1	*	4649
2	6350	5604
3	6375	7135
4	6695	5804
5	7215	*
6	*	2630
7	1596	3233
8	3762	*
9	1328	1617
10	2281	3803
11	3007	4408
12	1411	5812
13	1311	3964
14	1680	*
15	854	4843
16	*	*
17	2581	1913
18	*	1974
19	2153	3711

* indicates poor sporulation and is not included in the statistical analysis.