

# FEASIBILITY AND BENEFITS OF CONVERTING THE IRANIAN HEAVY WATER REACTOR IR-40 TO A MORE PROLIFERATION-RESISTANT REACTOR

THOMAS MO WILLIG

NORWEGIAN UNIVERSITY OF LIFE SCIENCES  
DEPARTMENT OF MATHEMATICAL SCIENCES AND TECHNOLOGY  
MASTER THESIS 30 CREDITS 2011



This page is left blank intentionally

# **Feasibility and benefits of converting the Iranian heavy water research reactor IR-40 to a more proliferation-resistant reactor**

Thomas Mo Willig

14. December 2011

"You could not even think without electricity, though I realize that even with electricity some of you may have a problem with that"

Walter Lewin, MIT

## Summary

This thesis examines a policy proposal presented by former Deputy Director-General for Safeguards in the International Atomic Energy Agency, Olli Heinonen, as a means to get Iran back to the negotiation table over its nuclear program [1]. He proposes modifying the Iranian heavy water research reactor IR-40, so that it uses low enriched uranium instead of natural uranium as fuel, thereby making the reactor less suitable for weapons-grade plutonium production, and more suitable for useful radioisotope production.

This thesis concretizes Heinonen's proposal, suggesting a conversion of the IR-40 reactor from using natural uranium to using low enriched uranium fuel. The original reactor, as well as the proposed modified reactor is modeled using SCALE 6.1, a reactor simulation program developed by Oak Ridge National, to determine if this conversion is feasible, and to estimate the potential for plutonium and radioisotope production in both configurations. Various methods are used to estimate the current design of the reactor and use the parameters deduced for that reactor as a basis for a converted reactor. A proposal is also made to cap Iran's enrichment capacity to a level where Iran can replace the yearly demand for the converted IR-40 reactor with enriched uranium. This could ease tensions regarding Iran's enrichment program and the focus of diplomacy could shift to confidence building between Iran and the IAEA.

## Samandrag

Denne masteroppgåva vil ta utgangspunkt i eit innspel frå tidligare direktør for beskyttelse i det internasjonale atomenergibyrådet Olli Heinonen, for å få Iran tilbake til forhandlingsbordet vedrørende atomprogrammet deira. Olli Heinonen foreslår å modifisera den iranske forskingsreaktoren IR-40 til å ta i bruk låganrika uran framfor naturleg uran, dermed gjera reaktoren mindre eigna til plutoniumsproduksjon av våpenkvalitet og meir eigna til radioisotopproduksjon.

Denne oppgåva vil konkretisera Heinonens forslag og foreslår ein konvertering av IR-40 til å ta i bruk låganrika uranbrensel. Den originale og konverterte reaktoren blir modellert i SCALE 6.1, eit reaktor simuleringsprogram utvikla av Oak Ridge National, for å finna ut om konverteringa er mogleg, og estimera potensialet for plutoniumsproduksjon og radioisotopproduksjon i begge konfigurasjonane. Det blir også foreslått å putta eit tak på Irans anrikingsmoglegheiter slik at dei dekke det årlige behovet til den konverterte IR-40 reaktoren med anrika uran. Dette kan løysa opp spenning angående Irans anrikingsprogram og diplomatiet kan skifta fokus til betre samarbeid mellom IAEA og Iran.

## Contents

	<b>List of figures</b>	<b>10</b>
	<b>List of tables</b>	<b>12</b>
	<b>Preface</b>	<b>13</b>
<b>1</b>	<b>Introduction</b>	<b>14</b>
1.1	Challenges facing Iran	14
1.2	Iran's nuclear program	15
1.2.1	Iran's secret nuclear program	16
1.2.2	The IR-40 heavy water research reactor	18
1.2.3	A new proposal	18
1.2.4	Thesis outline	19
<b>2</b>	<b>Nuclear physics</b>	<b>20</b>
2.1	Nuclear energy	20
2.1.1	Atomic structure	20
2.1.2	Isotopes	20
2.1.3	Nuclear forces	20
2.1.4	Radioactivity	21
2.2	Neutron reactions	21
2.2.1	Scattering	21
2.2.2	Capture	22
2.2.3	Fission	22
2.3	Neutron physics	24
2.3.1	Microscopic cross section	24

2.3.2	Macroscopic cross section	25
2.3.3	Varying cross section with neutron energy	25
2.3.4	Reaction rate	26
<b>3</b>	<b>Reactor physics</b>	<b>27</b>
3.1	Neutron moderation	27
3.2	Neutron life cycle	27
3.2.1	Four factor formula	27
3.3	Neutron transport	29
3.3.1	One-group diffusion theory	29
3.3.2	Two-group theory	30
3.3.3	Reflector savings	31
3.4	Reactor power	31
<b>4</b>	<b>Nuclear reactors</b>	<b>32</b>
4.1	Nuclear core	32
4.2	Light water reactors (LWRs)	33
4.3	Heavy water reactors (HWRs)	34
4.4	Graphite reactors	35
4.5	Fuel consumption	35
4.6	Criticality control	35
4.6.1	Prompt neutrons	36
4.6.2	Doppler broadening	36
4.6.3	Reactor poisons	36
4.6.4	Control rods	36



<b>5</b>	<b>Nuclear weapons</b>	<b>38</b>
5.1	Nuclear weapons material	38
5.2	Basic nuclear weapons design	38
5.2.1	Gun-type design	38
5.2.2	Implosion design	39
<b>6</b>	<b>Plutonium production</b>	<b>41</b>
6.1	Plutonium production	41
6.2	Plutonium quality	42
6.3	Plutonium production in HWRs	43
6.4	Reprocessing	43
<b>7</b>	<b>Isotope production</b>	<b>45</b>
7.1	Radioisotopes	45
7.2	Radioisotope production	45
7.2.1	Activity	45
7.2.2	Targets	46
7.2.3	Logistics	46
7.3	Radioisotope production in Iran	46
7.3.1	Molybdenum-99 production	46
7.3.2	Radioisotope production at the IR-40 reactor	49
<b>8</b>	<b>The IR-40 heavy water research reactor</b>	<b>50</b>
8.1	IR-40 specifications	50
8.2	Origin of the IR-40 design	51
8.2.1	Russian origin	51

8.3	Estimating the dimensions of the IR-40 reactor	54
8.3.1	Energy density comparison	54
8.3.2	Similar reactors	55
8.3.3	RBMK dimensions	56
8.3.4	Diffusion theory and buckling factor	57
8.3.5	Satellite images	58
8.3.6	Scientific publications	58
8.4	A possible IR-40 design	60
<b>9</b>	<b>Modeling and modification of the IR-40 reactor</b>	<b>61</b>
9.1	Monte Carlo methods	61
9.2	SCALE	61
9.2.1	CSAS6	62
9.2.2	TRITON	63
9.3	IR-40 reactor fueled by natural uranium	64
9.3.1	SCALE output	66
9.3.2	Plutonium production	67
9.3.3	Radioisotope production	69
9.4	Modified IR-40 reactor with LEU core	70
9.4.1	Fuel limitations	71
9.4.2	SCALE output	72
9.4.3	Plutonium production	74
9.4.4	Radioisotope production	79
9.4.5	Fuel consumption	79

9.4.6	Advantages	80
<b>10</b>	<b>Discussion</b>	<b>81</b>
	<b>References</b>	<b>82</b>
	<b>Appendix A</b>	<b>93</b>
	<b>Appendix B</b>	<b>98</b>
	RBMK dimensions	98
	Cooling considerations for LEU fuel.	98
	Corresponding enrichment requirements for the LEU core	98
	Mo-99 activity	99
	<b>Appendix C</b>	<b>101</b>

## List of figures

Figure 1-1.	A map of Iran. The 40 MW heavy water reactor built in Arak, 240 km south west from Tehran [7].	15
Figure 2-1.	The fission process.	22
Figure 2-2.	An illustration of a chain reaction, where one neutron initiates fission in a nucleus, which leads to three new neutrons which can then initiate fission in three new nuclei [30] (illustration used with permission from Wiley).	23
Figure 2-3.	Fission yield for thermal neutrons [31] (modified by the author).	24
Figure 2-4.	Varying cross sections for $\sigma_f$ in $^{92235}\text{U}$ (a) and $^{92238}\text{U}$ (b) at different neutron energies [28].	25
Figure 4-1.	A fuel pellet, a stack of fuel pellets and a 9 x 9 PWR fuel assembly. The figure was created in KENO3D. The 9 x 9 assembly consists of 72 pink $\text{UO}_2$ rods encapsulated in cyan Zircaloy. The nine gray rods are made of the burnable poison rods made out of boron carbide.	32
Figure 4-2.	An illustration of a Russian VVER reactor. 1 – Control rods; 2 – reactor cover; 3 – pressure vessel; 4 – inlet and outlet nozzles; 5 – reactor vessel; 6 – active reactor zone; 7 – fuel rods [35].	33
Figure 5-1.	A gun barrel design [40].	39
Figure 5-2.	A sketch of an implosion design NW [43].	40
Figure 6-1.	The buildup of various plutonium isotopes [46].	41
Figure 7-1.	The activity of $^{99}\text{Mo}$ as a function of irradiation time.	48
Figure 7-2.	An Iranian-produced technetium generator displayed by the AEOI during the 55th Annual Regular Session of the IAEA General Conference in Vienna 2011. (Photo: Halvor Kippe.)	48
Figure 8-1.	An overview of the IR-40 complex with the reactor located under the concrete dome in the center, and mechanical draft cooling towers in the lower right hand corner [70].	51
Figure 8-2.	Left. President Mahmoud Ahmadinejad interviewed next to an RBMK-resembling fuel assembly in the spring of 2009 [73]. Right. A graphical representation of an RBMK fuel assembly. The fuel assembly is composed of two concentric circles of fuel rods and a central support rod [74].	52
Figure 8-3.	An RBMK-resembling fuel assembly displayed in a brochure from the AEOI about the nuclear industry in Iran [21].	53
Figure 8-4.	Setup of a 40 MW HWR core with Standard Hydride Fuel [96]. The color code is, dark gray: black absorber, blue: reflector, light blue: fuel assemblies, cyan: light water [99]. The articles does not describe what a black absorber is.	59
Figure 9-1.	The flow chart of a CSAS6 sequence [101].	62
Figure 9-2.	The flow chart of a TRITON depletion sequence [109].	63
Figure 9-3.	A model of the fuel assembly used in the IR-40 reactor, produced by KENO3D. The figure to the left shows the end plug of the fuel assembly. Yellow is $\text{D}_2\text{O}$ while cyan is Zircaloy. The figure to the right shows 18 fuel pins arranged inside an assembly. The four fuel rods in the front have had their cladding removed for illustrative purposes.	

Zircaloy is shown in cyan, helium in green, UO <sub>2</sub> in red and nitrogen in blue. The central rod is a hollow Zircaloy rod filled with nitrogen. ....	64
Figure 9-4. An overview of the GeeWiz model of the IR-40 core. Hexagons containing only D <sub>2</sub> O are shown in green, yellow hexagons contain empty pressure tubes filled and surrounded by D <sub>2</sub> O, red hexagons are fuel assemblies, and the purple hexagon is an aluminum rod surrounded by D <sub>2</sub> O for measuring the neutron flux. ....	65
Figure 9-5. The view of the reactor produced by KENO3D with D <sub>2</sub> O and the top of the pressure vessel removed for illustrative purposes. The blue are fuel assemblies, gray is the pressure vessel and the red are aluminum rods for flux measurement. ....	65
Figure 9-6. The mass of plutonium isotopes as a function of the specific burnup and operating time. ....	68
Figure 9-7. The mass of plutonium isotopes as a function of the specific burnup and operating time. ....	68
Figure 9-8. The activity as a function of time of irradiation and neutron flux. ....	69
Figure 9-9. The activity as a function of time of irradiation and neutron flux. ....	70
Figure 9-10. The interior of the modified fuel assembly produced by KENO3D. The UO <sub>2</sub> rods are shown in pink, the aluminum-boron carbide rods in yellow and the central nitrogen filled rod in cyan. ....	73
Figure 9-11. An overview of the GeeWiz model for the modified IR-40 core. Hexagons containing only D <sub>2</sub> O are shown in green, yellow hexagons contain empty pressure tubes filled and surrounded by D <sub>2</sub> O, red hexagons are fuel assemblies, and white is an aluminum rod used for measuring the neutron flux. ....	73
Figure 9-12. An cut-out view of the modified IR-40 core generated by KENO3D. D <sub>2</sub> O and the top of the pressure vessel have been removed for illustrative purposes. The purple pressure tubes contain fuel, while the cyan pressure tubes are empty. ....	74
Figure 9-13. Plutonium production as a function of burnup and operation time at constant power. ....	76
Figure 9-14. Plutonium production as a function of burnup and operation time at constant power. ....	76
Figure 9-15. Plutonium production as a function of burnup and operation time at constant power. ....	77
Figure 9-16. Plutonium production as a function of burnup and operation time at constant power. ....	77
Figure 9-17. Plutonium production as a function of burnup and operation time at constant power. ....	78
Figure 9-18. Plutonium production as a function of burnup and operation time at constant power. ....	78

## List of tables

Table 6-1.	Approximate isotopic composition of various grades of plutonium [45;48] (modified by the author).....	42
Table 8-1.	Specifications of RBMK-1000 and RBMK-1500 fuel assemblies [77;78]. .....	54
Table 8-2.	Energy densities of selected HWRs [80],[81] [82;83]. .....	55
Table 8-3.	Data from heavy water research reactors [80;81] [84-86] [82;83;87-92] ....	56
Table 8-4.	Size of the IR-40 core estimated using diffusion theory.....	57
Table 8-5.	40 MW HWR specifications [95;96]. .....	60
Table 9-1.	Specifications for the IR-40 reactor based on estimates deduced in Chapter 8. 66	
Table 9-2.	Specifications for a modified IR-40 reactor fueled with LEU. ....	71
Table 9-3.	The different isotope compositions as a function of enrichment and burnup.....	75
Table 9-4.	The amounts of plutonium created as a function of enrichment and burnup. ....	75
Table 9-5.	The annual demand of LEU and the SWU needed for that amount as a function of fuel enrichment and capacity factor. ....	79

## Preface

Could Iran be offered a solution to a nuclear proliferation problem that would be acceptable to Iran and the world community at the same time? This thesis aims to investigate whether a conversion of IR-40 is feasible and what benefits that could give.

This thesis is written as a final part of the five year master program in Environmental Physics and Renewable Energy at the University of Life Science in Ås. The thesis has been written in cooperation with the Norwegian Defense Research Establishment.

Through my work with the thesis many people have been extremely helpful in guiding me from A – Z. I would especially like to thank the engineers and physicists at IFE for invaluable help in figuring out how to model a nuclear reactor and how to interpret the answers. I cannot thank my supervisors enough for all the help and guidance they have provided me during the last six months.

I am also very grateful to all the teachers and professors I've had over the last 19 years, you made learning fun and managed to put something useful between my ears.

I'm going to miss the companionship of my fellow students at UMB. You have made my four and a half years at UMB a joyful experience. It has always been "god stemming" at UMB.

A special thanks to my family and Tuva for holding out with me, when I spend way too much time working on my studies.

# 1 Introduction

## 1.1 Challenges facing Iran

Iran is strategically located between the Arab peninsula and Central Asia as shown in Figure 1-1. Iran shares borders with regional powers such as Iraq, Turkey, Afghanistan and Pakistan. This is an unstable part of the world. Pakistan is struggling with internal problems such as sectarian violence, and the regime is stockpiling nuclear weapons [2]. Iraq is rebuilding after the coalition invasion led by the United States in 2003, and the chaos that followed. Iran also fought a bitter war with Iraq from 1980-1988 [3]. After ten years of NATO-led military operations, Afghanistan is still an unstable state and it is uncertain what will happen when NATO forces pull out.

Iran's political landscape is also unstable. In 1953 the democratically elected, nationalistic prime minister Mohammed Mosaddeq was toppled by the US-backed Shah. The Shah, a monarch, ruled Iran from 1953 to 1979. In a revolution in 1979, the Shah was toppled. The revolution turned into an Islamic one, as Ayatollah Ruhollah Khomeini emerged as the spiritual and de facto, strong-handed leader of the new Islamic Republic of Iran. Today there is an elected government, which is currently led by Mahmoud Ahmadinejad, who is responsible for the political, economical and day-to-day running of the country, but the current spiritual leader, Ayatollah Khamenei, has the last word in important matters. After the presidential election in 2009, there was widespread turmoil over the election results which the reform movement claimed was fraudulent, but the protests were ultimately violently struck down by the sitting regime [3].

Economically Iran is very dependent on its petroleum industry. The petroleum industry accounts for 85% of Iran's total income. However, the export of petroleum products is being limited as a large share is used internally due to a long history of large subsidies on gasoline and dependence on gas-fired power plants for electricity production [4]. This is illustrated by the fact that Iran has the second largest known gas reserves in the world, but is only the 27<sup>th</sup> biggest gas exporter. In addition, the demand for both electricity and gasoline is increasing in Iran due to a rapidly growing population [5].

The large domestic use of petroleum products has been used by Iranian authorities as an argument for pursuing nuclear power and thereby freeing up valuable petroleum products for export. Iran's pursuit of nuclear technology has sparked major international concern because it could be misused for military applications [6]. Repeated attempts of concealing nuclear facilities in Iran have not alleviated these concerns [5].





Figure 1-1. A map of Iran. The 40 MW heavy water reactor built in Arak, 240 km south west from Tehran [7].

## 1.2 Iran's nuclear program

Iran's nuclear program was initiated in 1957 when Iran and the United States (US) signed an agreement on corporation on civilian nuclear power as a part of the US-led *Atoms for Peace Program* [5].

The US built Iran's first nuclear reactor, the Teheran Research Reactor (TRR). TRR is a 5 mega watt thermal ( $MW_{th}$ ) reactor which went into operation in 1967 and is still in use [5]. Iran also has a small 30 kilo watt thermal ( $kW_{th}$ ) *light water reactor* (LWR) which has been in operation since the mid 1990s and functions as a neutron source for scientific experiments. Iran also operates a small 100  $W_{th}$  *heavy water reactor* (HWR), a critical assembly and two subcritical assemblies which have all been built by China [8;9].

Following the 1973-74 oil crisis, the Shah launched ambitious plans for building a total of 23 gigawatt electric ( $GW_e$ ) nuclear power capacity. Only one project was started in Bushehr in 1975 by German *Kraftwerk Union* (KWU). The original plan was to build two 1200  $MW_e$  *pressurized water reactors* (PWRs). After the revolution, payment to KWU halted and

construction stopped, leaving one plant nearly completed and the other plant half finished. During the Iran – Iraq war, the plant was repeatedly damaged by Iraqi air strikes and construction efforts were neglected [10]. In 1994, Russia and Iran came to an agreement for completing the reactors at Bushehr as Russian PWRs, called VVER-1000 reactors [11]. One reactor has been completed and delivered electricity to the grid in 2011 and is planned to reach full capacity in February 2012 [12;13].

According to the stated plans for the expansion of nuclear power, Iran envisages a total capacity of 7 GW<sub>e</sub> by 2020 and 20 GW<sub>e</sub> by 2030 [5]. Iran pursues self-sufficiency in its nuclear fuel production, although Russia has agreed to provide fuel for the Bushehr reactor during its first 20 years of operation [5].

### **The International Atomic Energy Agency (IAEA) and the Nuclear Non-Proliferation Treaty (NPT)**

The IAEA was established in 1957 with an objective to promote safe, secure and peaceful use of nuclear energy. The creation of IAEA was attributed to US president Dwight Eisenhower, who promoted an organization to oversee the Atoms for Peace Program [14].

The NPT is an international treaty whose objective is to prevent the spread of nuclear weapons (NW) and weapons technology, to promote cooperation on peaceful use of nuclear energy, and achieving NW disarmament. The NPT went into effect in 1970. Through the NPT, IAEA is given the mandate to monitor all non-nuclear weapons member states' compliance to the non-proliferation provisions of the treaty. Article III commits the non-nuclear weapons states to negotiate and implement a safeguards agreement with the IAEA, to enable inspections of all nuclear activities and materials in the respective state. Iran concluded its Comprehensive Safeguards Agreement (CSA) with the IAEA in 1974 [15].

#### **1.2.1 Iran's secret nuclear program**

In 2002, National Council of Resistance of Iran, a rebel faction in Iran, unveiled evidence that Iran was building a nuclear facility in Natanz and a heavy water production plant (HWPP) near the city of Arak. The facility in Natanz was later identified as a uranium enrichment<sup>1</sup> plant. The initial allegations were supported up by commercial satellite images showing large-scale building activities at these locations [5].

---

<sup>1</sup> Naturally occurring uranium largely consists of two different isotopes of uranium. About 0.7 % of the uranium is in the form of the isotope uranium-235 and the rest is uranium-238.

In February 2003, half a year after the disclosure of these facilities, the Iranian authorities sent a letter to the IAEA (see Fact Box) stating their intentions to build the HWPP. Iran claimed no wrong-doing in not declaring these facilities at an earlier stage, because according to the original subsidiary arrangements to the CSA, Iran was only obliged to report new facilities 180 days prior to introducing nuclear materials to the facility [15;16]. Under a more updated and stricter interpretation of these obligations, (the so-called modified code 3.1 to the subsidiary arrangements of the CSA), new facilities would have to be declared as soon as a construction order, or permission to construct, was given. Iran voluntarily agreed to the modified code in a letter to IAEA in 2003, but went back on their promises in 2007, and now cling to the old phrasing [17]. IAEA frequently points out that Iran is the only country with significant nuclear activities that insists on this outdated interpretation of its declaratory commitments [18].

Iran stated that the purpose of the enrichment plant was to acquire a complete nuclear fuel cycle to provide fuel to its future fleet of reactors [5]. Many Western countries are worried that the enrichment program could be part of a covert nuclear weapons program, where Iran could enrich uranium to weapons-grade quality (typically around 90 % uranium-235, in contrast to 3 – 5 % in commercial power reactor fuel). This concern has led to four United Nations Security Council (UNSC) sanction resolutions prompting Iran to halt the enrichment [19]. Iran argues that its enrichment program is entirely legal under the NPT Article IV (see Fact Box) on the right to develop civilian nuclear applications, and maintains that Iran does not want to depend on foreign countries for supplies of enriched uranium fuel.

Iran was confronted by the IAEA in 2003 with questions about the origin and nature of its enrichment technology, whereby Iran admitted to having received enrichment technology from foreign sources [16]. In 2004, Abdul Qadeer Khan, also known as the father of the nuclear bomb in Pakistan admitted to having sold enrichment technology to several countries, including Iran [5].

In a safeguards report released by the IAEA November 2011, the IAEA has serious concerns regarding possible military dimensions of the Iranian nuclear program. The IAEA finds it overall credible that Iran performed research on NWs technology up until 2003, and that some parts of these activities continued after 2003 [18].

---

Uranium enrichment is a process whereby the weight fraction of uranium-235 is increased relative to the fraction of uranium-238.

### 1.2.2 The IR-40 heavy water research reactor

In May 2003 Iran sent another letter stating their intentions to also build a HWR named IR-40 near the city of Arak [16].

Iran claims that the proposed IR-40 reactor is a necessary and suitable replacement for its aging TRR [20]. The purpose of the IR-40 reactor is allegedly to produce radioisotopes for medical and industrial applications, train nuclear personnel and obtaining technological and scientific experience in design and construction of nuclear reactors using local experts [21].

Iran attempted to acquire a research reactor from abroad without success. In 1996, Iran received proposals from China and Russia on three different research reactors, but no agreement was made [20]. Iran concluded that the only option was to build an indigenous heavy water reactor, and use domestically produced natural uranium (NU) oxide fuel with Zircaloy encapsulation [16].

As of July 2011, the construction of the IR-40 reactor is reported by the Atomic Energy Organization of Iran (AEOI) to be 82% completed [21]. Iran has reported that the reactor will commence operations by the end of 2013 [22]. The facility is not under IAEA safeguards yet because of Iran's refusal to comply with the modified code 3.1, as discussed above. Iran has nevertheless let IAEA inspect the plant on several occasions, the last visits being twice in 2011 and once in 2010 and 2009 [22-25].

HWRs fueled with NU are very well suited for producing plutonium of a quality suitable for nuclear weapons [26]. Iran could extract up to 8-10 kg of weapons-grade plutonium (WG<sub>Pu</sub>)<sup>2</sup> each year from fuel irradiated in the IR-40 reactor. That amount of WG<sub>Pu</sub> is sufficient material for the construction of one to two nuclear weapons per year, depending on the weapon design. Because of the proliferation risks connected to the IR-40 reactor, the IAEA's Board of Governors has called upon Iran to halt all its heavy-water related projects in several resolutions [8;23]. This has also been demanded by the UNSC in several resolutions. To this date, Iran has ignored all such demands [25].

### 1.2.3 A new proposal

In January 2011 former Deputy Director-General for Safeguards in the International Atomic Energy Agency Olli Heinonen wrote an article in Foreign Policy where he proposed modifying the IR-40 reactor design to accommodate a new research reactor using low-enriched uranium [1].

---

<sup>2</sup> WG<sub>Pu</sub> is defined as plutonium containing at least 93 % of the isotope plutonium-239. Detailed information regarding plutonium quality is given in Chapter 6.

This would result in a substantial part of Iran's current stock of low-enriched uranium to be redirected for the research reactor as fuel and not be available for further enrichment to nuclear weapons quality.

#### 1.2.4 Thesis outline

This thesis outlines a proposal for Iran to choose a different design for the IR-40 reactor that limits the reactor's capacity for producing WGPu compared to the current design, while enhancing its ability to function as a research reactor. The current design characteristics of the IR-40 reactor are not known. To estimate the characteristics of the reactor, various methods are employed, such as comparing it with other research reactors, gathering information from Iranian scientific articles and IAEA reports, and employing nuclear engineering principles. A likely reactor design is then deduced. This reactor is simulated using SCALE 6.1, a nuclear reactor simulation program, estimating the reactor's effective multiplication factor as well as the potential plutonium and radioisotope production. A modified reactor design is then proposed.

Chapter 2 and 3 describe the basic theory of nuclear reactors. Chapter 2 introduces the fundamental concepts in nuclear physics and radioactivity. It describes the fission process and different neutron interactions. Chapter 3 describes the neutron life cycle and neutron transport in a reactor. The concept of material and geometric buckling is introduced as a mean of estimating the minimum size of a nuclear core. Different nuclear reactor designs and their characteristics are presented in Chapter 4. It describes how the nuclear chain reaction is maintained at a stable level during operation.

In Chapter 5, the basic physics of nuclear weapons and nuclear weapons material is described. The two basic nuclear weapons designs, gun-type and implosion-type are presented. The production of plutonium and radioisotopes is described in Chapters 6 and 7. Chapter 6 describes the different compositions of plutonium isotopes and what qualifies some compositions as weapons-grade.

Chapter 8 describes possible IR-40 reactor design characteristics, using available sources as well as deductions and estimates based on reactor physics. In Chapter 9, a computer simulation program called SCALE, developed by Oak Ridge National Laboratory in Tennessee USA, is employed to test the reactor geometries estimated in Chapter 8 and calculate an effective multiplication factor for the reactor, the core inventory as well as potential plutonium and radioisotope production. Finally, the results are discussed and summarized in chapter 10.

## 2 Nuclear physics

### 2.1 Nuclear energy

#### 2.1.1 Atomic structure

The periodic table consists of 118 known elements, where each element consists of atoms of a particular composition. The atom is constituted of a core surrounded by a cloud of electrons. The core, also known as the nucleus, is very small compared to the size of the atom [27].

The nucleus is populated by two different particles of almost identical mass: protons and neutrons. The protons are positively charged while the neutrons are electrically neutral. A specific atom (also called nuclide) is often denoted  ${}^A_ZX$ , where X is the chemical symbol of the element, Z is the number of protons in the nucleus and A is the sum of the protons and neutrons in the nucleus. A is known as the mass number [27].

#### 2.1.2 Isotopes

Atoms containing a fixed number of protons but different numbers of neutrons are called isotopes. Isotopes of different elements can exhibit very different nuclear properties, although chemically they are practically identical. This is because the chemical properties are governed by the electron configuration which remains the same for isotopes of the same atom [27].

One example is uranium where the most abundant isotope  ${}^{238}_{92}U$  is not usable in nuclear weapons, but the lighter isotope  ${}^{235}_{92}U$  is [27].

#### 2.1.3 Nuclear forces

Inside the nucleus there exists an attractive force called the *strong nuclear force*. The strong nuclear force operates on short ranges only acting on the nucleons inside the nucleus, in contrast to the electromagnetic Coulomb force which operates on a much longer range. Inside the nucleus the strong nuclear force overcomes the repellent Coulomb force if the nucleus is populated by more than one proton [27].

As the number of protons in the nucleus increases, the repellent Coulomb force increases. To counter the increasing Coulomb force, nuclei with many protons have a set of extra neutrons which up to a certain extent leads to a more stable nucleus because of the increased attractive nuclear force [27].

Another nuclear force operating on an even smaller scale than the nucleus is the *weak nuclear force*. It is called weak because it is  $10^{-12}$  times weaker than the strong nuclear force. Weak nuclear force plays an important role in radioactive decay because it enables unstable

nuclei to change protons into neutrons or neutrons into protons which leads to a lower energy state and the emission of particles from the nucleus [28].

#### 2.1.4 Radioactivity

A nucleus becomes unstable if it has too much internal energy. In order to achieve stability the nucleus gets rid of this excess energy through radioactive decay. Radioactive decay is divided into three main types of radiation [27].

Heavy elements such as uranium often have too many protons in their nucleus to stay stable. To reach a lower energy level, a heavy element emits an alpha particle made up of two protons and two neutrons, so-called *alpha decay* [27]. The alpha particle is denoted  $\alpha$  and is identical to a helium nucleus.

If a nucleus contains too many neutrons, it can transform one of its neutrons into a proton, or if it has too many protons convert a proton to a neutron. These changes involve a process whereby the nucleus emits an electron or a positron<sup>3</sup> and an anti-neutrino or a neutrino<sup>4</sup>. This is known as *beta radiation* and is symbolized by  $\beta^-$  or  $\beta^+$  [29].

A nucleus may return to its ground energy state by emitting *gamma radiation*, consists of high energy photons, denoted  $\gamma$  [27].

## 2.2 Neutron reactions

The neutron is an important particle in nuclear physics. Due to its electrical neutrality, it is not affected by the Coulomb force. Neutrons are normally located inside nuclei, but they can also exist for a short time outside the nucleus and interact with other nuclei. These interactions are sorted into three categories; *scattering*, *capture* and *fission* [27].

### 2.2.1 Scattering

A free moving neutron may bump into a nucleus and give away some of its kinetic energy while changing direction (scattering). The scattering can be either elastic or inelastic.

In an inelastic scattering, the neutron is absorbed in the target nucleus which transforms to a compound nucleus before a neutron of lower kinetic energy is released. The energy difference is converted to excitation energy in the target nucleus. In an elastic scattering, the total kinetic energy of the neutron and the scattered nucleus is unchanged after the collision.

---

<sup>3</sup> A positron is a positively charged electron.

<sup>4</sup> A neutrino is particle without charge and very small mass. It hardly interacts with matter.

## 2.2.2 Capture

In contrast to positively charged particles that would be stopped by the repulsive Coulomb force, the neutron is able to come near and inside the nucleus. The process whereby a neutron is absorbed into a nucleus is called a *capture reaction*.

For a neutron with little kinetic energy, there are four possible outcomes following *neutron capture*. The most common one is the emission of gamma radiation ( $n, \gamma$ ) from the nucleus. The other three are emission of an alpha particle ( $n, \alpha$ ) or proton ( $n, p$ ) from the nucleus, or a fission process ( $n, f$ ).

For a high energetic neutron, ( $n, \alpha$ ) and ( $n, p$ ) reactions are more probable than ( $n, \gamma$ ). Because of the higher kinetic energy carried by a fast-moving neutron, reactions such as ( $n, 2n$ ) and ( $n, np$ ) are also possible.

## 2.2.3 Fission

Following absorption of a neutron the nuclei may become so unstable that it breaks apart in a fission process. The fission process releases a huge amount of energy. The energy released is given by the mass difference between the initial nucleus and the resulting fission fragments, and is given by Einstein's formula

$$E = \Delta mc^2 \quad (1)$$

where  $\Delta m$  is the mass defect and  $c$  is the speed of light. The average energy release caused by fission of a heavy nucleus is about 200 megaelectronvolts (MeV) [27].

The fission process may be illustrated by the nuclear liquid drop model [28]. In the liquid drop model, the nucleus is regarded as an electrically charged drop. In Figure 2-1 a neutron is absorbed in a fissile core in situation A and makes the nucleus excited. The nucleus starts to oscillate in B until it resembles a dumbbell in C. The Coulomb force is then able to overcome the strong, short-range nuclear force and the nucleus splits apart in D.

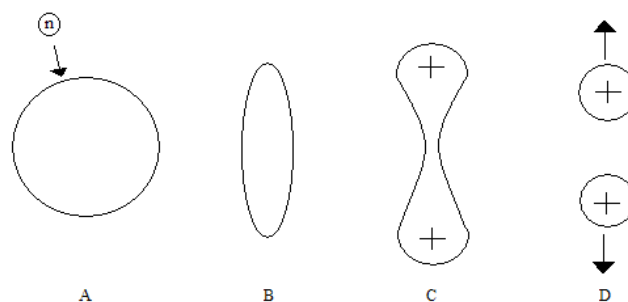

Figure 2-1. The fission process.



The fission process usually divides the nucleus into two fission fragments and two to three free neutrons, accompanied by gamma radiation. If at least one of these free neutrons initiates another fission, we may have the start of a nuclear *chain reaction* where the fission process is self-sustaining [29]. Figure 2-2 illustrates the principle of a chain reaction, where one fission sets in motion many subsequent fissions.

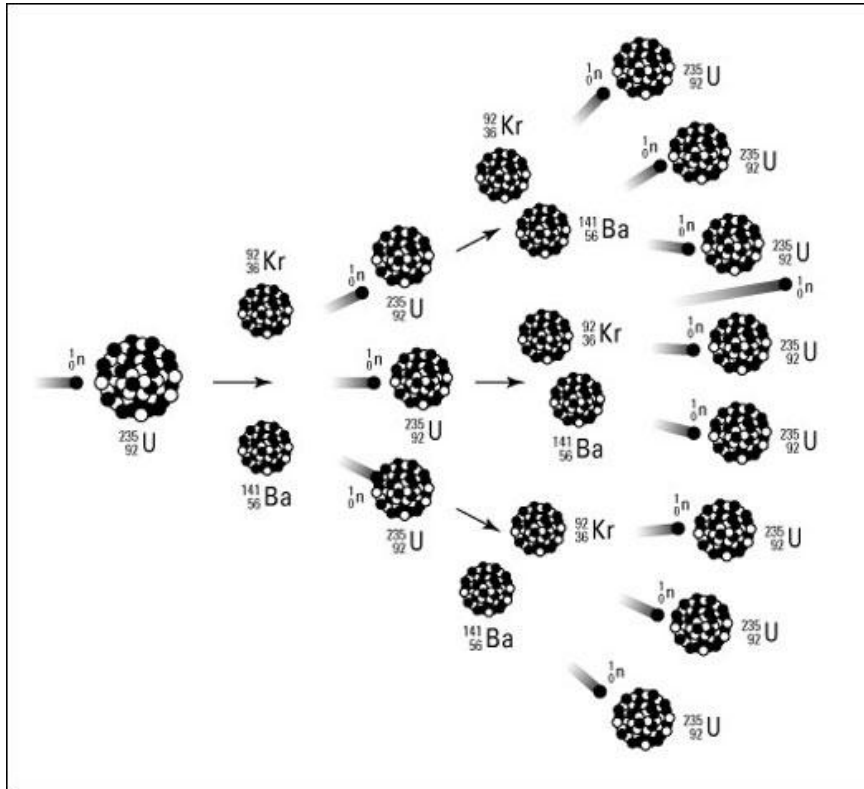
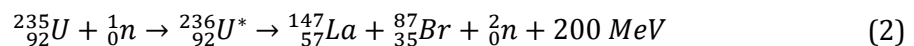

Figure 2-2. An illustration of a chain reaction, where one neutron initiates fission in a nucleus, which leads to three new neutrons which can then initiate fission in three new nuclei [30] (illustration used with permission from Wiley).

A possible fission reaction is



Fission in equation (2) is initiated by a neutron being absorbed in a  ${}_{92}^{235}\text{U}$  nucleus which goes into a temporary excited state of  ${}_{92}^{236}\text{U}^*$ . The unstable  ${}_{92}^{236}\text{U}^*$  breaks down to the fission fragments  ${}_{57}^{147}\text{La}$  and  ${}_{35}^{87}\text{Br}$ , two free neutrons and 200 MeV of energy. The majority of the energy is released is constituted by kinetic energy in the two fission fragments.

Many fission reactions are possible, resulting in different fission fragments with mass numbers in the range  $\sim 70 - 160$ . The resulting fission fragments are lumped into two regions shown in Figure 2-3 according to their yield. The two peaks are centered around the mass numbers 96 and 135, indicating that fragments with these mass number are the most

probable [28]. As the y axis in Figure 2-3 is logarithmic, symmetric fissions are therefore rare events compared to asymmetric fissions.

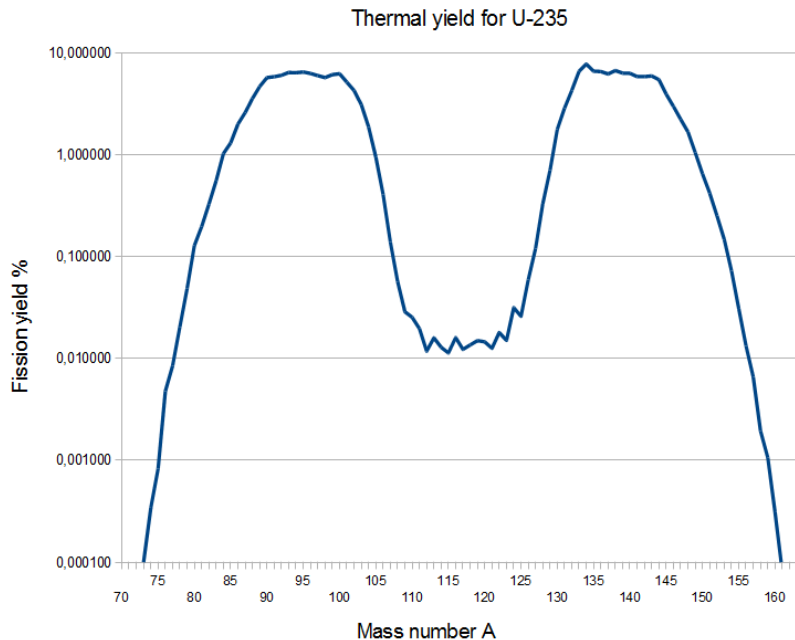

Figure 2-3. Fission yield for thermal neutrons [31] (modified by the author).

Nuclides that undergo fission by neutrons of any energy are called *fissile*, (for example  $^{235}_{92}\text{U}$ ), while those that only fission at high neutron energies are called *fissionable* (for example  $^{238}_{92}\text{U}$ ). Nuclides that become fissile after first absorbing a neutron, are called *fertile* (i.e.  $^{238}_{92}\text{U}$  may absorb a neutron and become fissile  $^{239}_{94}\text{Pu}$ ) [29].

## 2.3 Neutron physics

The neutron plays a dual role as both “glue” to hold the nucleus together and initiator of many nuclear reactions. The following section describes important parameters used to characterize neutron interactions.

### 2.3.1 Microscopic cross section

The different interactions between neutrons and nuclei can be described by the concept of *cross sections* [28]. The cross section for a given neutron - nucleus reaction is a measurement of the probability of that particular interaction. The cross section is a property of the target nucleus and the energy of the incoming neutron [27].

The cross section for a neutron – nucleus interaction is called the *microscopic cross section* and is denoted  $\sigma$ . The microscopic cross section is measured in  $m^2$ . As the cross section of a single nucleus is very small, about the cross section area of the actual nucleus, a derived unit called *barn* (b) is commonly used, where  $1 \text{ b} = 10^{-28} m^2$ .

### 2.3.2 Macroscopic cross section

A slab of material usually consists of more than a single nucleus. Taking into account many nuclei, we obtain *the macroscopic cross section*  $\Sigma$  [28]. A slab composed of  $N$  nuclei per  $m^3$  multiplied by the microscopic cross section  $\sigma$  yields

$$\Sigma = N \cdot \sigma \quad (3)$$

The dimension of  $\Sigma$  is  $m^{-1}$ .

### 2.3.3 Varying cross section with neutron energy

The probability of an interaction  $\sigma$  between a neutron and a nucleus is very dependent on the energy of the incoming neutron. In general, a slow moving neutron has a much higher probability of interacting with a nucleus than a fast moving neutron [27]. This is illustrated in the upper half of Figure 2-4 where the isotope usually used in nuclear reactors,  $^{235}_{92}\text{U}$ , has a significant higher fission cross section at low neutron energies than high energies. The lower half of Figure 2-4 illustrates the fissile nature of  $^{238}_{92}\text{U}$  which only fissions at high neutron energies over 1 MeV (i.e. by fast neutrons).

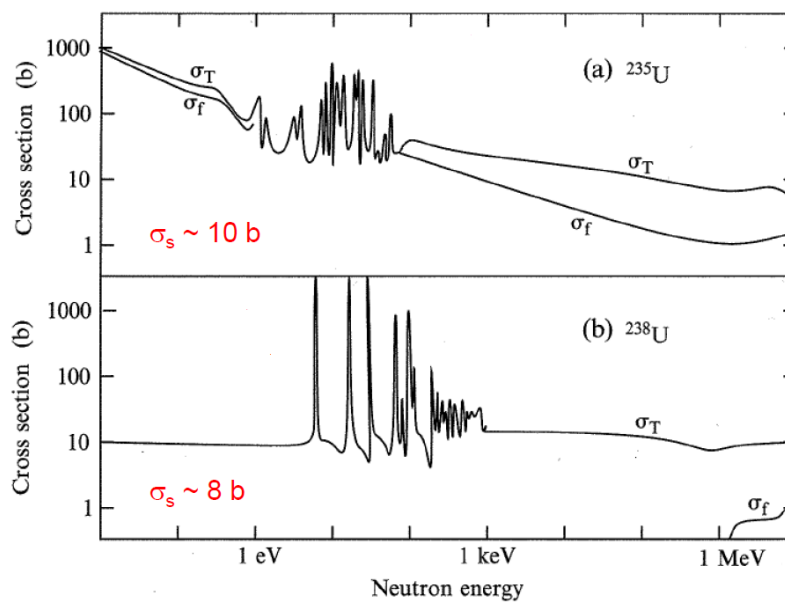

Figure 2-4. Varying cross sections for  $\sigma_f$  in  $^{235}_{92}\text{U}$  (a) and  $^{238}_{92}\text{U}$  (b) at different neutron energies [28].

$\sigma_T$ ,  $\sigma_s$ ,  $\sigma_f$  in Figure 2-4 represent the total, scattering and fission cross sections, respectively.

The different neutron cross sections are classified into three broad regions depending on their energy. The three regions are called *thermal*, *epithermal* and *fast*. Neutrons released by

fission have energies between 0.1 MeV and 10 MeV and are called fast. Neutrons having energies of 0.001 eV to 1 eV are said to be thermal. The neutrons having an energy between 1 eV to 0.1 MeV are called epithermal [32].

#### 2.3.4 Reaction rate

In a nuclear reactor, the neutron density is  $n$  neutrons per unit volume. Neutrons travel with a speed  $v$  and their interactions are described by  $\Sigma$ . The number of interactions per unit volume and time is given by

$$R = n \cdot v \cdot \Sigma \quad (4)$$

where  $R$  is the *reaction rate* [28]. The product  $n \cdot v$  is an important quantity in reactor physics and is also written as

$$\phi = nv \quad (5)$$

where  $\phi$  is the *neutron flux*.  $\phi$  is usually given as *neutrons/cm<sup>2</sup> · s*. The reaction rate is proportional to the neutron flux, and the higher the neutron flux the more reactions will take place.

## 3 Reactor physics

The previous chapter showed the basic nuclear physics for initiating a nuclear chain reaction. This chapter will briefly explain how to achieve and sustain a nuclear chain reaction in a nuclear reactor.

### 3.1 Neutron moderation

The probability that a neutron will cause fission in fissile materials increases with decreasing neutron energy (Figure 2-4 top). It is therefore beneficial to slow down neutrons. The process of slowing them down is called *moderation*. Moderation is achieved by exposing a neutron to a series of scattering reactions, in which the neutron loses some of its kinetic energy in each collision. After a number of collisions the kinetic energy of the neutron is reduced to the average kinetic energy of the atoms in the scattering medium. The neutron is then in thermal equilibrium with the scattering medium, and is thus called a *thermal* neutron (i.e. the neutron is *thermalized*) [27].

Neutrons lose their energy most efficiently when colliding with light elements such as hydrogen, beryllium and carbon [28]. Common moderating materials are thus water, heavy water and graphite. Water and heavy water are the most popular moderators because they also function as coolant [29].

### 3.2 Neutron life cycle

In nuclear reactors, free neutrons are born in fission events and may go through a series of processes before they contribute to the chain reaction or do not contribute. These processes can be illustrated by looking at the neutron's life cycle in a uranium fuel reactor.

#### 3.2.1 Four factor formula

The fates of neutrons released by fission are determined by the physical factors of the nuclear material and geometry of the nuclear reactor. The set of possible outcomes is described by the so-called four factor formula [28].

##### 3.2.1.1 Reproduction factor $\eta$

The reproduction factor  $\eta$  is the number of neutrons released after a fission event.  $\eta$  is specific for each fissile isotope, and is determined by the fission to absorption ratio. The higher the uranium enrichment, the higher the average  $\eta$  will be. Values for  $\eta$  range from 1.328 for natural uranium with 0.7%  $^{235}_{92}\text{U}$  to 2.06 for pure  $^{235}_{92}\text{U}$ .

### 3.2.1.2 Fast fission factor $\epsilon$

If there is a fraction of  $^{238}_{92}\text{U}$  in the fuel, there is a chance that high energy neutrons may immediately undergo a fission reaction after being absorbed in  $^{238}_{92}\text{U}$ . This causes extra neutrons to be added to the chain reactions. This property is called the *fast fission factor*  $\epsilon$ . Common values for  $\epsilon$  are in the range of 1.02-1.08 [29].

### 3.2.1.3 Resonance escape probability $p$

When neutrons are moderated, there is a possibility that they are absorbed and removed from the chain reaction in the epithermal region in  $^{238}_{92}\text{U}$  shown in the lower half of Figure 2-4. The *resonance escape probability*  $p$  is the probability that the neutrons escape absorption in  $^{238}_{92}\text{U}$ . Typical values for  $p$  range from 0.8 to 0.9 [33].

### 3.2.1.4 Thermal utilization factor $f$

Neutrons may be absorbed in the moderator or other material located in the reactor before they reach the fuel. The fraction that makes it to the fuel is called *thermal utilization factor*  $f$ . Typical values for  $f$  are 0.94-0.98 [32].

### 3.2.1.5 Criticality

Multiplying the four terms together, we obtain a factor indicating if the neutron population has increased, decreased or is in a steady state [28]. For a core of infinite size with no loss of neutrons the four factor formula yields

$$k_{\infty} = \eta \epsilon p f \quad (6)$$

where  $k_{\infty}$  is the *infinite multiplication factor*.

All practical reactors are of finite size, so there is a possibility that fast and thermal neutrons will escape the reactor without interacting with the fuel. Accounting for this loss of neutrons,  $P$  is added to the four factor formula and represents the fraction of neutron that stay in the reactor

$$k_{eff} = \eta \epsilon p f P \quad (7)$$

where  $k_{eff}$  is the *effective multiplication factor*. In normal reactor operations  $k_{eff}$  is equal to 1 and the reactor is said to be *critical*. When the reactor is critical there are created as many neutrons as are absorbed or escaped. If  $k_{eff}$  is less than one the chain reaction dies out and the reactor is *sub-critical*. If  $k_{eff}$  is higher than one the neutron population will grow and the reactor is called *super-critical* [27].

To minimize the loss of neutrons from the reactor, it is common to use a *neutron reflector*. A neutron reflector is a layer of scattering material surrounding the core where the fuel is

located, and is often made of the same material as the moderator. The reflector reflects some of the neutrons back into the core and reduces the amount of fuel and volume needed to make a reactor go critical [29;32].

### 3.3 Neutron transport

The key design criterion of a nuclear reactor is accounting for the production, transport and absorption of neutrons in the reactor. To keep track of the neutrons, neutron transport equations which express the distribution of neutrons in space, energy and time have been developed [27].

#### 3.3.1 One-group diffusion theory

One of the simplest approximations of transport theory is called *diffusion theory* approximation. It assumes that neutrons diffuse from areas of high to areas of low neutron concentrations [28].

For a steady state, one-group situation where we assume that all neutrons have the same energy ( i.e. one energy group), the diffusion equation (derived from Fick's laws) is given as

$$D\nabla^2\phi - \Sigma_a\phi + v\Sigma_f\phi = 0 \quad (8)$$

The first term in equation (8) is the neutron leakage term, the second term is neutron absorption and the last is the neutron production term. D is a constant of proportionality called the *diffusion coefficient* and has dimensions of length,  $\phi$  is the neutron flux,  $\Sigma_a$  is the total macroscopic absorption cross section,  $v$  is the number of new neutrons from fission and  $\Sigma_f$  is the total macroscopic fission cross section [34].

The source term  $v\Sigma_f\phi$  can also be given as  $k_\infty\Sigma_a\phi$ , yielding

$$D\nabla^2\phi - \Sigma_a\phi + k_\infty\Sigma_a\phi = 0 \quad (9)$$

or by rearranging

$$\nabla^2\phi + \left[ \frac{(k_\infty - 1)\Sigma_a}{D} \right] \phi = 0 \quad (10)$$

Using the relation  $D/\Sigma_a = L_T^2$ , where  $L_T$  is the *thermal diffusion length* and is the distance traveled by neutrons while at thermal energies, we obtain

$$\nabla^2\phi + \frac{(k_\infty - 1)}{L_T^2} \phi = \nabla^2\phi + B_m^2\phi = 0 \quad (11)$$

where  $B_m^2$  is called *material buckling* and is a property of the material in the reactor and is given by

$$\frac{k_{\infty} - 1}{L_T^2} = B_m^2 \quad (12)$$

This leads to the critically criterion

$$\frac{k_{\infty}}{1 + L_T^2 B_m^2} = 1 \quad (13)$$

For a critical reactor with  $k_{\text{eff}} = 1$ ,  $B_m^2$  may be calculated and set equal to the *geometrical buckling factor*  $B_g^2$  [27].  $B_g^2$  is a function of the geometry of the reactor. Using the relationship  $B_m^2 = B_g^2$ , it is possible to determine the critical radius and height of a reactor as a function of  $k_{\infty}$ .

For a bare<sup>5</sup> cylindrical core  $B_g^2$  is given as

$$B_g^2 = \left(\frac{2.405}{R}\right)^2 + \left(\frac{\pi}{H}\right)^2 \quad (14)$$

where  $R$  is the radius of the cylinder and  $H$  is the height.

### 3.3.2 Two-group theory

A better approximation than the one-group theory is the two-group theory, where there are two energy groups, one for fast neutrons and the other for thermal neutrons. Equation (13) is modified to

$$\frac{k_{\infty}}{(1 + L_T^2 B_m^2)(1 + L_S^2 B_m^2)} = 1 \quad (15)$$

where  $L_S$  is the *slowing-down* length traveled as the neutrons slow down from fast to thermal energies in the moderator [28].  $L_T^2$  and  $L_S^2$  are normally given for pure moderators [29].

If there is little leakage in the system, equation (15) becomes

$$\frac{k_{\infty}}{1 + B_m^2(L_T^2 + L_S^2)} = 1 \quad (16)$$

Equation (16) may also be written as

$$\frac{k_{\infty}}{1 + B_m^2 M^2} = 1 \quad (17)$$

where  $M^2$  is called the *migration area* and given as  $M^2 = L_T^2 + L_S^2$ .

---

<sup>5</sup> A bare core is a core without a neutron reflector.



Accounting for the “pollution” made by the fuel in the moderator, a new value for the thermal diffusion length is introduced

$$L^2 = (1 - f)L_T^2 \quad (18)$$

where  $f$  is the thermal utilization factor [27]. Equation (16) is modified to

$$\frac{k_\infty}{1 + B_m^2(L_s^2 + L^2)} = 1 \quad (19)$$

### 3.3.3 Reflector savings

If a neutron reflector is present the critical size of the core is reduced. For a reflector several diffusion lengths thick, which is the case for almost all reactors, the critical height and radius of the core may be reduced by an amount called *reflector savings* which is given by

$$\delta \simeq \frac{\bar{D}_c}{\bar{D}_r} L_{Tr} \quad (20)$$

where  $\bar{D}_c$  and  $\bar{D}_r$  is the diffusion coefficient for the core and the reflector, and  $L_{Tr}$  is the thermal diffusion length of the reflector [29].

## 3.4 Reactor power

One fission releases 200 MeV or  $3.2 \cdot 10^{-11}$  J of recoverable energy. To produce 1 W requires fission of  $3.12 \cdot 10^{10}$  nuclei per second [27].

By multiplying the average reaction rate with the reactor core volume and dividing by the number of fissions per W second, we can determine the total power produced by the reactor:

$$P = \frac{V \cdot \bar{\Sigma}_f \cdot \bar{\phi}}{3.12 \cdot 10^{10}} \quad (21)$$

where  $P$  is the thermal output in Watts,  $\bar{\phi}$  is the average thermal neutron flux in neutrons/cm<sup>2</sup>·s,  $\bar{\Sigma}_f$  is the average macroscopic cross section in cm<sup>-1</sup> and  $V$  is the core volume given in cm<sup>3</sup> [27].

$V$  and  $\bar{\Sigma}_f$  are fixed parameters for a given reactor. The power of the reactor is thus proportional to the average neutron flux  $\bar{\phi}$ , or vice versa.

## 4 Nuclear reactors

A variety of nuclear reactor designs have emerged since Enrico Fermi constructed the first man made nuclear reactor in December 1942 [29]. Nuclear reactors are used to produce heat for electricity production, plutonium for nuclear weapons, radioisotopes for medicine or use neutrons for scientific research [28]. A comprehensive description of various nuclear reactor designs can be found in [27;29;32].

### 4.1 Nuclear core

Most nuclear reactors are thermal reactors, i.e. reactors with a thermal neutron energy spectrum, with a heterogeneous core [29]. A heterogeneous core is a reactor where the fuel is lumped together, rather than being evenly distributed in the core. The fuel is normally made up of small pellets of uranium dioxide ( $UO_2$ ) approximately 1 cm high and 1 cm in diameter. The pellets are stacked on top of each and encapsulated in a thin-walled tube. This constitutes a *fuel rod*. The walls of the fuel rod are made of a material that does not readily absorb neutrons, and is called *cladding*. The most common cladding material is *Zircaloy*, which is a common name for alloys consisting mostly of zirconium. Fuel rods are arranged in bundles to create a *fuel assembly* illustrated in Figure 4-1. A reactor consists of many fuel assemblies arranged in a geometry that enables the reactor to go critical [29]. The distance from the centre one fuel assembly to the centre of the next fuel assembly is called the *lattice pitch*.

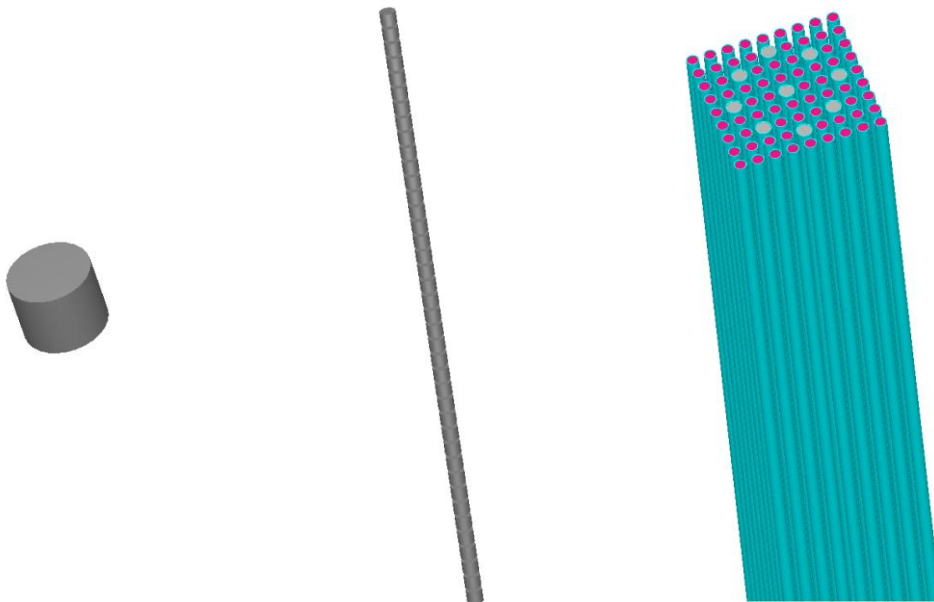

*Figure 4-1. A fuel pellet, a stack of fuel pellets and a 9 x 9 PWR fuel assembly. The figure was created in KENO3D. The 9 x 9 assembly consists of 72 pink  $UO_2$  rods encapsulated in cyan Zircaloy. The nine gray rods are made of the burnable poison rods made out of boron carbide.*

An illustration of a *pressure vessel* containing the *reactor core* is shown in Figure 4-2. The core is located below the inlet and outlet for the coolant in case there should be a leak in the cooling circuit.

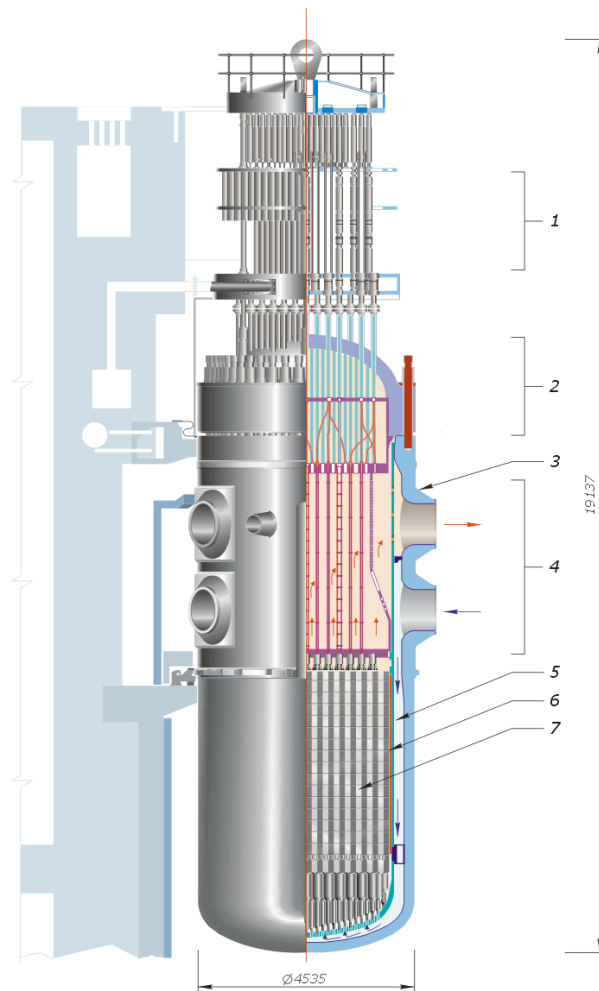

Figure 4-2. An illustration of a Russian VVER reactor. 1 – Control rods; 2 – reactor cover; 3 – pressure vessel; 4 – inlet and outlet nozzles; 5 – reactor vessel; 6 – active reactor zone; 7 – fuel rods [35].

For thermal, heterogeneous reactors there are three main classes of reactors, distinguished by what type of moderating material they employ.

#### 4.2 Light water reactors (LWRs)

The light water reactor is the most common reactor for electricity production [29]. It is moderated and cooled by ordinary water, but to distinguish it from a heavy water reactor it is called a light water reactor.

Because of neutron absorption in light water, LWRs must be fueled by enriched uranium [29]. Commercial power reactors are fueled with 3-5 % enriched uranium (LEU, see Fact Box), while smaller research reactors are sometimes fueled with more than 90 % enriched uranium (HEU, see Fact Box).

For commercial LWRs, there are two principal designs, *pressurized water reactors* (PWRs) and *boiling water reactors* (BWRs) [29]. In a PWR the pressure in the reactor is kept at 150 bars to keep the water from boiling, whereas in a BWR, the water is allowed to boil and the pressure is 70-80 bars. A typical LWR has a thermal output of around 3000 MW<sub>th</sub>, with an electric power capacity around 1000 MW<sub>e</sub> [27]. The reactors are normally operated for about 1 to 2 years before refueling. After that period, the reactor is shut down for several weeks to replace about 20-30 % of the core with fresh fuel [32].

Enriched uranium containing up to 20 %  $^{235}_{92}\text{U}$  is classified as *low-enriched uranium*, or LEU [36].

Enriched uranium containing more than 20 %  $^{235}_{92}\text{U}$  is classified as *highly enriched uranium*, or HEU [36].

Enriched uranium containing more than 90 %  $^{235}_{92}\text{U}$  is classified as *weapons-grade uranium*, or WGU [36].

### 4.3 Heavy water reactors (HWRs)

HWRs employ heavy water, which is often shorted as D<sub>2</sub>O, as a moderator and normally as coolant as well [28]. For commercial power plants the most common design is the *CANada Deuterium Uranium* (CANDU) reactor [29].

In CANDU reactors, the fuel is located in many individual pressure tubes with D<sub>2</sub>O. The pressure tubes run through a big tank called the *calandria* filled with D<sub>2</sub>O [27]. Because of D<sub>2</sub>O's smaller scattering cross section compared to light water, the lattice pitch for HWRs is larger than for LWRs in order to scatter the neutrons down to thermal energies [29]. This makes the HWR reactor larger than a LWR reactor of the same thermal output.

As D<sub>2</sub>O has a low absorption cross section, it is possible to run HWR on natural uranium. In CANDU reactors, fuel can be replaced while the reactor is running, so-called *online refueling* and long shut downs like in LWRs can be avoided [29].

#### 4.4 Graphite reactors

Graphite reactors employ graphite as moderating material. The cooling medium is either gas or light water. Since graphite has a smaller scattering cross section than D<sub>2</sub>O, graphite reactors have bigger cores than LWRs and HWRs for the same thermal output [32].

The most common light water cooled graphite reactor is the Russian *reaktor bolshoy moshchnosti kanalniy* (RBMK) reactor [32]. RBMK reactors do not employ a pressure vessel around the core, but like CANDU use pressure tubes for each fuel assembly. RBMK reactors became infamous after the Chernobyl disaster in 1986. The pressure tube design allows RBMKs to be refueled online like the CANDU reactors [29].

Another type of graphite reactor is the *Magnox* reactor. This is a CO<sub>2</sub> cooled reactor which employs natural uranium metal fuel clad in magnesium alloy [29]. This reactor was developed by the UK and France [37].

#### 4.5 Fuel consumption

The total energy released by fission by a nuclear reactor is called *burnup*, and is measured in megawatt days (MWd). As a rule of thumb, it takes 1.23 grams of <sup>235</sup><sub>92</sub>U to produce 1 MWd of energy [29].

The energy released per unit mass of fuel is called *specific burnup*, and is given by megawatt days per metric ton of heavy metal in the original fuel. As the heavy metal is mostly uranium, the specific burnup is also given by MWd/tU [29].

#### 4.6 Criticality control

In order to maintain a stable power level and conduct safe reactor operation, the neutron population needs to be held constant, except at start up and shut down. To describe the deviation from a constant neutron population, it is normal to use the term *reactivity* which is given as

$$\rho = \frac{k_{eff} - 1}{k_{eff}} \quad (22)$$

If the neutron population is stable,  $k_{eff}$  is equal to 1 and  $\rho$  is zero [32]. A  $k_{eff}$  higher than 1 means there is positive reactivity, while  $k_{eff}$  lower than 1 means there is negative reactivity.

Different physical phenomenon and control mechanisms play an important role in the stability of the neutron population. Some of the most important ones are discussed below.

#### 4.6.1 Prompt neutrons

Neutrons released by fission are either prompt or delayed. The prompt neutrons are released immediately after fission and account for about 99.3 % of the neutron population. The delayed neutrons come from the decay of fission products (0.65 % of the neutron population for  $^{235}_{92}\text{U}$ ), and play a vital role in keeping the reactivity in check.

The time between emission of a neutron and absorption in fuel is called the *prompt neutron lifetime* [32]. If the prompt neutron lifetime is 0.1 ms<sup>6</sup>, a small reactivity change of 0.001 would lead to an increase in the neutron population of 22000 times in one second and a massive heat development. When accounting for the delayed neutrons, a doubling of the neutron population takes 58 seconds. This is more than enough time for reactor operators to provide counter-measures and lower the reactivity [29].

#### 4.6.2 Doppler broadening

Neutrons moving through the epithermal region in  $^{238}_{92}\text{U}$  illustrated in Figure 2-4 (bottom), can be absorbed in the resonances and removed from the neutron population. If the temperature of the fuel in a reactor increases as a result of positive reactivity, the vibration energy of the  $^{238}_{92}\text{U}$  nuclei increases. This causes the resonance peaks of  $^{238}_{92}\text{U}$  to spread out over a larger energy range. This is called *Doppler broadening*. The Doppler broadening results in a higher probability of neutron absorption in  $^{238}_{92}\text{U}$ . This reduces the neutron population and subsequently the power of the reactor [27].

#### 4.6.3 Reactor poisoning

In an operating, reactor the concentration of certain fission products (notably xenon and samarium) with high neutron-capture cross sections builds up. These fission products are called *reactor poisons* because they cause the  $k_{eff}$  to decrease.  $^{135}_{54}\text{Xe}$  capture cross section is  $2.75 \cdot 10^6$  b [28].

#### 4.6.4 Control rods

An operating reactor needs to start operations with an excess reactivity in order to still be critical as the fuel is consumed and reactor poisons build up [27].  $k_{\infty}$  for a fresh core may vary between 1.12 for a CANDU to 1.41 for a PWR [32].

To ensure stable operations as reactor poisons build up and fuel is consumed, rods made out of highly neutron absorbing material called *control rods* are inserted into the reactor core. Control rods are divided in three categories. *Shim rods* are used to remove large excess

---

<sup>6</sup> 0.1 ms is an approximate value for a LWR. CANDU reactors have a prompt neutron lifetime of about 1 ms [38].

reactivity at the start of operation, *regulator rods* are used for fine adjusting the power distribution in the core and *safety rods* are kept outside the core in normal operation and can be inserted into the core in case of an emergency.

At the start of operations, the regulator rods may be fully inserted, as fuel is consumed and reactor poisons build up, the rods are gradually withdrawn [29]. The 9x9 assembly in Figure 4-1 has nine neutron absorbing rods. In Figure 4-2 the control rods are inserted through the top of the reactor into the core.

It is also possible to add neutron absorbing material to the coolant/moderator. This is called a *chemical shim* and is usually done by adding boric acid. *Burnable neutron poisons* may also be blended directly into the fuel pins themselves [29].

## 5 Nuclear weapons

The previous chapters illustrate how the energy stored inside nuclei can be extracted without the reactor going supercritical. In a nuclear weapon (NW), on the other hand, one tries to release as much nuclear energy as fast as possible. The utilization of nuclear energy in NWs makes their energy output up to 10 million times more powerful than regular high explosives bombs and level whole cities [37;39].

### 5.1 Nuclear weapons material

The critical factor in all NWs is the fissile material which gives rise to the nuclear chain reaction. The fissile material used in NWs is either in the form of HEU or plutonium<sup>7</sup> [37].

For uranium it is possible, but not practical, to use LEU. The higher the level of enrichment, the smaller the size and mass is required for a uranium based NW. Modern uranium weapons employ WGU and may have a mass as low as 10 kg [29;37].

Plutonium in NW consists of a mix of different isotopes, where the most abundant isotope is  $^{239}_{94}\text{Pu}$ . More detailed information on the composition of plutonium isotopes is given in Table 6-1. About 5 kg of plutonium is required for a NW. If the NW manufacturer has high level of skill, a low yield NW may employ as little as 1 kg of plutonium [37].

### 5.2 Basic nuclear weapons design

A NW is designed to fission as many fissile nuclei as possible before the weapon disintegrates and the chain reaction stops. The chain reaction is maintained by fast neutrons and no moderator is present. It is important to avoid initiating the chain reaction before optimal conditions have been reached, otherwise there is a risk of predetonation and a lower explosive yield. To ensure a high explosive yield and avoid predetonation, two principle NW designs are employed.

#### 5.2.1 Gun-type design

The gun-type design is the simplest NW design. It consists of two subcritical masses of fissile material placed at the opposite ends of a barrel which by themselves cannot initiate a chain reaction. To start the chain reaction one of the subcritical masses is accelerated towards the other by the means of high explosives. It is propelled like a bullet down a gun barrel, as illustrated in Figure 5-1, hence the name gun-type. The two masses merge and become a supercritical mass which rapidly undergoes many fissions and release its energy in an exponential manner [37].

---

<sup>7</sup> It is in theory possible to use artificially produced heavy nuclides, but that is impractical.



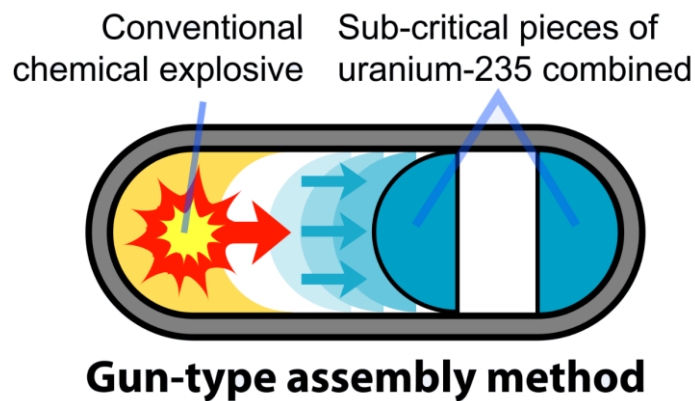

Figure 5-1. A gun barrel design [40].

The gun-type design only works with uranium as the fissile material. Plutonium has too many spontaneous fissions<sup>8</sup> events, and if used would predetonate and achieve a significantly reduced explosive yield (a so-called fizzle) [37].

The bomb dropped over Hiroshima in 1945 – Little Boy - was a crude gun-type design with two parts of 80 % enriched uranium with a combined mass of 64 kg [41;42].

### 5.2.2 Implosion design

An implosion-type NW consists of one subcritical spherical mass of fissile material, the so-called *pit*. The pit is brought to supercritical density by a spherical compression driven by high explosives, as illustrated in Figure 5-2.

In order to use plutonium in a NW, an implosion design must be employed. The NW dropped over Nagasaki – Fat Man - in August 1945 was of implosion design with plutonium as fissile material. Fat Man employed as little as 6 kg of plutonium, but right under 2 tons of high explosives [42].

---

<sup>8</sup> A heavy nucleus may undergo fission spontaneously and release free neutrons [28].

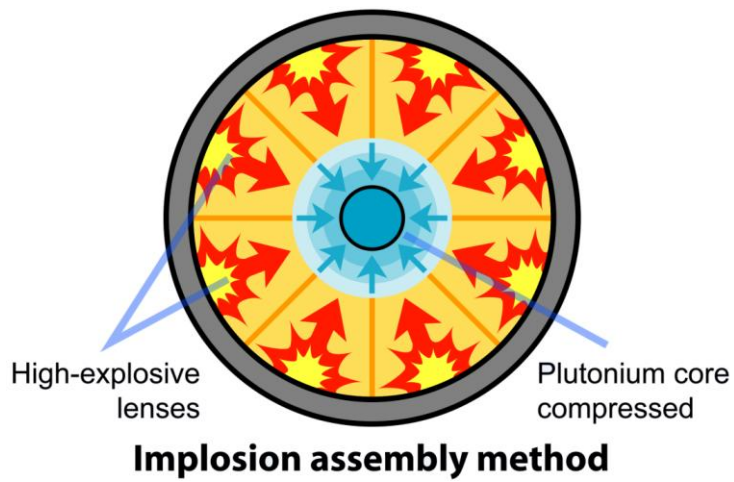

*Figure 5-2. A sketch of an implosion design NW [43].*

In the latest IAEA safeguards report from November 2011, IAEA suspected Iran to have been conducting research on implosion weapon design [18]. This has been strongly denied by Iranian authorities [44].

## 6 Plutonium production

Plutonium is only found in trace amounts in nature. To generate enough plutonium for a NW, a nuclear reactor is required. When the IR-40 reactor is put into operation, it will be able to produce up to 10 kg weapons-grade plutonium per year [17].

### 6.1 Plutonium production

Plutonium is produced in all nuclear reactors containing  $^{238}_{92}\text{U}$  through nuclear transmutation. The process begins with a  $^{238}_{92}\text{U}$  nucleus absorbing a free neutron and undergoing two successive beta decays before it ends up as  $^{239}_{94}\text{Pu}$ . The reaction can be written as

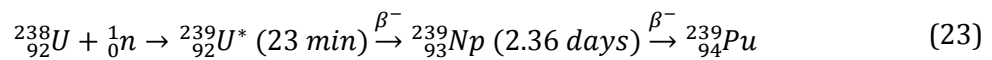

where the times are the half-lives of the different isotopes. The half-life of  $^{239}_{92}\text{Pu}$  is 24000 years [28]. In addition to  $^{239}_{92}\text{Pu}$  other plutonium isotopes are produced by successive neutron capture, (n,2n) reactions or beta decays as illustrated in Figure 6-1. The most abundant isotopes are  $^{238}_{92}\text{Pu}$ ,  $^{240}_{92}\text{Pu}$ ,  $^{241}_{92}\text{Pu}$  and  $^{242}_{92}\text{Pu}$ . The abundance of plutonium isotopes other than  $^{239}_{92}\text{Pu}$  increases with the reactor specific burnup [45].

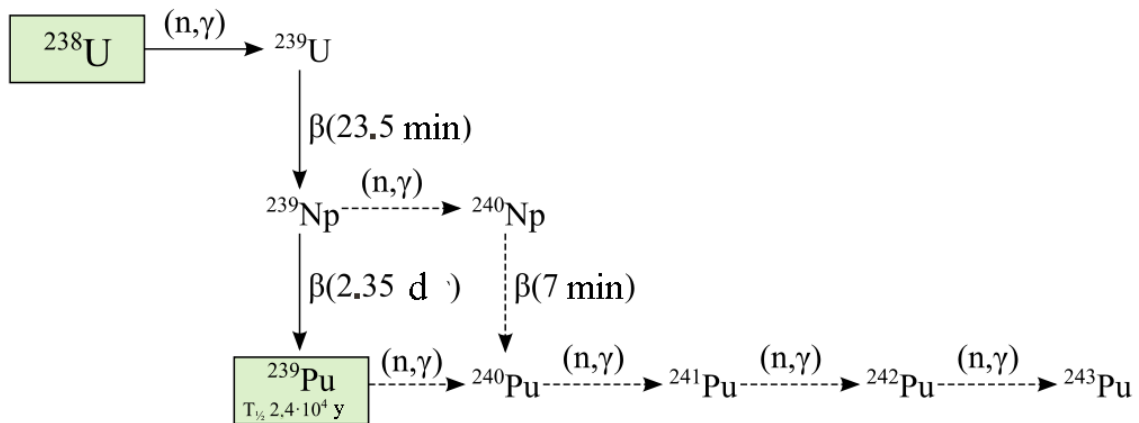

Figure 6-1. The buildup of various plutonium isotopes [46].

Plutonium production in a nuclear reactor is given by

$$M_{\text{plutonium}} = P_{\text{thermal}} \cdot x \text{ days} \cdot F \quad (24)$$

where  $P_{\text{thermal}}$  is the thermal output of the reactor,  $x$  is the number of days the reactor has been operating at full power, and  $F$  is a *conversion factor* given by the specific burnup. For a HWR running on natural uranium at low burnup, the conversion factor is 0.9 g/MW<sub>th</sub>-day [26].

If we assume that Iran operates the IR-40 reactor for 300 days each year, leaving 60 days for fuel swapping and down time, we obtain a mass of plutonium of

$$M_{\text{plutonium}} = 40 \text{ MW} \cdot 300 \text{ days} \cdot 0.9 \text{ g/MW}_{th} = 10.8 \text{ kg}$$

As a rule of thumb, we can assume that a HWR of 1 MW will produce 1 gram of plutonium per day [37].

## 6.2 Plutonium quality

Plutonium used in nuclear weapons is classified according to its different isotopic compositions shown in Table 6-1. The different qualities are arranged according to the percentage of  $^{240}_{94}\text{Pu}$  in the composition. If the composition has less than 6-7% of  $^{240}_{94}\text{Pu}$ , the plutonium is considered weapons-grade. A plutonium composition containing significant amounts of  $^{240}_{94}\text{Pu}$  will be problematic for use in NWs because it has a high rate of spontaneous fission events. This can trigger a premature detonation shortly after supercriticality is achieved, but before maximum criticality is reached [37]. This is also the case for  $^{238}_{94}\text{Pu}$  and  $^{242}_{94}\text{Pu}$ . In addition,  $^{238}_{94}\text{Pu}$  and  $^{241}_{94}\text{Pu}$  produce a lot of decay heat due to their short half-lives of 87 and 14 years, respectively [47]. The decay heat can deteriorate and deform the high explosives surrounding the pit [48].

The different qualities are determined by how long the fuel has been irradiated [26;49]. Super- and weapons-grade plutonium correspond to short irradiation times. Such plutonium qualities emerge from spent fuel with a specific burn up of less than 1200 MWd/tU. In commercial, power-producing reactors, one would want to irradiate the fuel as long as possible for economical purposes, thus achieving much higher burn ups and poorer plutonium quality from a weapons-perspective [37].

Grade of plutonium	Isotope					SF <sup>10</sup> [per g-s]	Decay heat [W/kg]
	$^{238}_{94}\text{Pu}$	$^{239}_{94}\text{Pu}$	$^{240}_{94}\text{Pu}$	$^{241}_{94}\text{Pu}^9$	$^{242}_{94}\text{Pu}$		
Super-grade	-	0.98	0.02	-	-	20	2.0
Weapons-grade	0.00012	0.938	0.058	0.0035	0.00022	66	2.3
Reactor-grade <sup>11</sup>	0.013	0.603	0.243	0.091	0.050	360	10.5

Table 6-1. Approximate isotopic composition of various grades of plutonium [45;48] (modified by the author).

<sup>9</sup> Pu-241 + Am-241.

<sup>10</sup> Spontaneous fission events.

<sup>11</sup> Plutonium recovered from low-enriched LWR with a 33 GWd/tU burnup after being stored for 10 years before reprocessing.

Even though plutonium is categorized by various qualities, the common isotopes are all capable of forming a critical mass and sustaining a chain reaction. Thus, virtually any combination of plutonium isotopes can be used in nuclear weapons [50]. But  $^{239}_{94}\text{Pu}$  is the preferred isotope for bomb makers because of its low heat generation, low spontaneous fission (compared to the other isotopes) and less specific radioactivity [45].

The use of plutonium in NW has some advantages over uranium. Plutonium has a higher fission cross section at higher neutron energies and a higher neutron yield per fission [37]. These two factors make the critical mass of plutonium smaller than the critical mass of WGU, thus enabling smaller weapons of the same explosive yield. Drawbacks with plutonium are that it is highly toxic and radioactive, which makes it harder to work with. Plutonium is also a pyrophoric material, and thus has to be handled in an inert atmosphere in order not to self-combust [51].

### 6.3 Plutonium production in HWRs

There are four advantages that make HWRs such as the IR-40 reactor more suitable for plutonium production than LWRs. As a HWR can run on natural uranium, relative more  $^{238}_{92}\text{U}$  is available for neutron capture compared to LEU fuel. The second advantage is  $\text{D}_2\text{O}$ 's smaller scattering cross section, which results in more collisions required for neutrons to reach thermal energies [48]. This in turn results in more neutrons getting caught in the  $^{238}_{92}\text{U}$  resonance absorption region, see Figure 2-4. The third advantage is that less neutrons are absorbed in the  $\text{D}_2\text{O}$  moderator compared to light water. The fourth advantage is the possibility of changing fuel while the reactor is still running, thus saving time by not having to replace larger parts of the core which is a time consuming operation [52].

### 6.4 Reprocessing

In order to use plutonium in a NW, it has to be separated from the irradiated fuel. This requires a reprocessing facility [53]. Plutonium is extracted using the so-called *PUREX*<sup>12</sup> process in which uranium and plutonium is extracted from irradiated fuel [29]. Plutonium is then separated from uranium and cast into metal spheres.

Reprocessing has been used in the civilian sector to re-use uranium and to separate plutonium from spent fuel and recycling it back into the fuel cycle as *mixed oxide fuel* (MOX) [37].

---

<sup>12</sup> PUREX is short for *Plutonium URanium EXtraction*. Irradiated fuel is dissolved in nitric acid, and a series of chemical extraction processes are employed to isolate plutonium and uranium.

To this date there are no indications that Iran is building any reprocessing facilities in connection with the IR-40 reactor. Iran also denies that it has any plans to build a reprocessing facility in the future [17]. If Iran does decide to build a reprocessing facility, the technology is widely known, but it requires special equipment that can be hard to come by. Iran conducted small scale reprocessing experiments on used fuel irradiated in the TRR between 1988 and 1992 [53].

## 7 Isotope production

Iran has stated that one of the main tasks of the IR-40 reactor is isotope production for medical and industrial use. In a letter sent in 2003 to the IAEA, Iran made references to the production of the isotopes of molybdenum, iodine, xenon, cobalt and iridium in the IR-40 reactor. Iran provided a sketch for a hot cell<sup>13</sup> facility next to the IR-40 reactor with a capability of handling radioactivities from 100 to 10000 curies, corresponding to 3.7 TBq to 370 TBq [8].

### 7.1 Radioisotopes

Radioactive isotopes are often called radioisotopes. The decay rate and type of decay ( $\alpha$ ,  $\beta$  or  $\gamma$ ) determines the usefulness of the radioisotope. Radioisotopes can be used in various fields such as medicine, industry and agricultural applications. Some of the most commonly used radioisotopes are Cs-137, Co-60, I-131, Ir-192, Mo-99 and Y-90 [54].

### 7.2 Radioisotope production

Radioisotopes are produced in reactors as fission products (see Figure 2-3) or through neutron capture. Fission of uranium results in 80 different fission products, predominantly radioisotopes, while neutron capture results in one specific radioisotope [27].

The production rate of radioisotopes is governed by the neutron flux and the amount of target material. The higher the neutron flux and the more target material, the faster and higher the activity of the desired radioisotopes will be produced [55]. The Australian OPAL reactor irradiates its target in a flux of up to  $9 \cdot 10^{13}$  neutrons/cm<sup>2</sup> · s, while the South African SAFARI-1 can irradiate targets in a thermal flux of  $1.5 \cdot 10^{14}$  neutrons/cm<sup>2</sup> · s [56;57].

#### 7.2.1 Activity

Radioisotopes are classified by their activity. The activity is measured as the number of disintegrations per second, where 1 Bq is one disintegration per second [28]. For radioisotopes, however, it is common to use the quantity *curie*, *Ci*, where 1 curie is equal to 37 GBq.

Activities of radioisotopes may also be represented by *six days curie*. As radioisotope naturally disintegrate, short-lived isotopes are labeled with a “guaranteed” activity six days after they leave the producer [55].

---

<sup>13</sup> A *hot cell* is a shielded facility where it is safe to handle highly radioactive material.

## 7.2.2 Targets

In a nuclear reactor, radioisotopes are produced by exposing a small target of uranium or other elements to the neutron flux produced by the reactor core. The uranium targets are normally made of LEU or HEU [55].

The targets can be fabricated as cylinders or plates and are encased in a material that does not absorb neutrons readily such as aluminum [55;58;59].

## 7.2.3 Logistics

After reaching the desired activity, the target is extracted from the reactor and put to cool in a water pool for a short time period. In this time most of the short-lived isotopes will have disintegrated, making it less radioactive and easier to work with [55].

After being cooled, the target is dismantled and the desired radioisotopes are isolated and purified. For short-lived isotopes this process needs to be quick in order to minimize the loss of activity.

## 7.3 Radioisotope production in Iran

Iran built a separation facility for handling radioisotopes at Tehran Nuclear Research Center in 2005. Iran has plans to synthesize up to 20 different radioisotopes [60]. But the facility has not been able to work satisfactorily since completion [61;62].

The most suitable reactor for producing radioisotopes in Iran is TRR because it has the largest thermal neutron flux of Iran's research reactors with a maximum thermal flux of  $3 \cdot 10^{13}$  neutrons/cm<sup>2</sup> · s [63]. But currently TRR is operating at lower than design capacity because Iran is running short of LEU fuel [64]. Iran is currently enriching uranium with the intentions to produce LEU fuel for the TRR indigenously. Previously, fuel has been imported from the USA between 1967 and 1979 and from Argentina in the mid 1990s [65].

### 7.3.1 Molybdenum-99 production

One of the radioisotopes Iran wants to produce is molybdenum-99 or <sup>99</sup>Mo. The decay product of <sup>99</sup>Mo, technetium-99m<sup>14</sup> or <sup>99m</sup>Tc, is the workhorse of radioisotopes for medical uses worldwide [66].

---

<sup>14</sup> The "m" signifies that <sup>99m</sup>Tc is *meta-stable*. A meta-stable isotope is an excited state of an isotope, which rapidly decays by gamma emission to the ground state (so-called *internal transition*). In this case,  ${}^{99m}\text{Tc} \xrightarrow{\gamma} {}^{99}\text{Tc}$ .



Because  $^{99m}\text{Tc}$  has a half-life of only 6.6 hours, it is not practical to produce  $^{99m}\text{Tc}$  and distribute it.  $^{99}\text{Mo}$  has a half-life of 66 hours, and is used to produce and transport  $^{99m}\text{Tc}$ . When  $^{99}\text{Mo}$  has arrived at its destination of use, a device such as the one shown in Figure 7-2 is used for separating  $^{99m}\text{Tc}$  produced by decay of  $^{99}\text{Mo}$ .

$^{99}\text{Mo}$  is one of the most common fission products from a thermal reactor that uses  $^{235}_{92}\text{U}$  as fissile material. The cumulative yield of  $^{99}\text{Mo}$  from fission of  $^{235}_{92}\text{U}$  is 6.13 % [67]. The common production method of  $^{99}\text{Mo}$  is thus to expose a small target of uranium to the neutron flux in the reactor for a period of three to eight days, in which the target reaches 50-85 % of its saturation activity (*i.e.* when the production rate is equal to the decay rate). [56;57;68].

The activity of  $^{99}\text{Mo}$  per  $\text{cm}^3$  produced by fission in a uranium target is given by

$$A = \frac{Y_{\text{Mo}99} \cdot \sigma_f \cdot \varepsilon \cdot \rho_U \cdot N_A \cdot \phi}{M_U \cdot k} \cdot \left(1 - e^{-\frac{\ln 2}{2.75} t_{irr}}\right) \quad (25)$$

where  $Y_{\text{Mo}99}$  is the fission yield of  $^{99}\text{Mo}$ ,  $\sigma_f$  is the fission cross section,  $\varepsilon$  is the enrichment,  $\rho_U$  is the density of uranium,  $M_U$  is the molar mass,  $N_A$  is Avogadro's number,  $\phi$  is the thermal neutron flux,  $k$  is a conversion factor from Bq to Ci and  $t_{irr}$  is the number of days the target is being irradiated [67;68].

In an Iranian publication from 2002, the demand for  $^{99}\text{Mo}$  in Iran was stated to be about 20 Ci per week, where only 12 Ci would be available due to decay [58]. The targets discussed in the article were natural pressed  $\text{UO}_2$  targets shaped in a cylindrical geometry and encased in aluminum. The cylinder was 19 cm high with a radius of 0.6 cm. The target had a density of 4.67  $\text{g}/\text{cm}^3$  and a mass of 100 g [58].

The maximum thermal neutron flux at TRR is reported to be  $3 \cdot 10^{13}$  neutrons/ $\text{cm}^2 \cdot \text{s}$ , which is lower than recommended for producing  $^{99}\text{Mo}$  without producing too much waste [69]. But the publication from 2002 operate with a maximum thermal neutron flux for the TRR core of  $5.7 \cdot 10^{13}$  neutrons/ $\text{cm}^2 \cdot \text{s}$ , while it is calculated to be  $4.0 \cdot 10^{13}$  neutrons/ $\text{cm}^2 \cdot \text{s}$  inside the target [58].

Using equation (22) and the target intended for TRR, the activity after seven days at a flux of  $4.0 \cdot 10^{13}$  neutrons/ $\text{cm}^2 \cdot \text{s}$  will reach 52 Ci. The activity is plotted in Figure 7-1. See Appendix B for calculations. This is somewhat higher than the Iranian estimate, where they receive 37.5 Ci after seven days of irradiation. This may be attributed to self-shielding, where the neutron flux drops towards the center of the target, which is not accounted for in equation (25) [29].

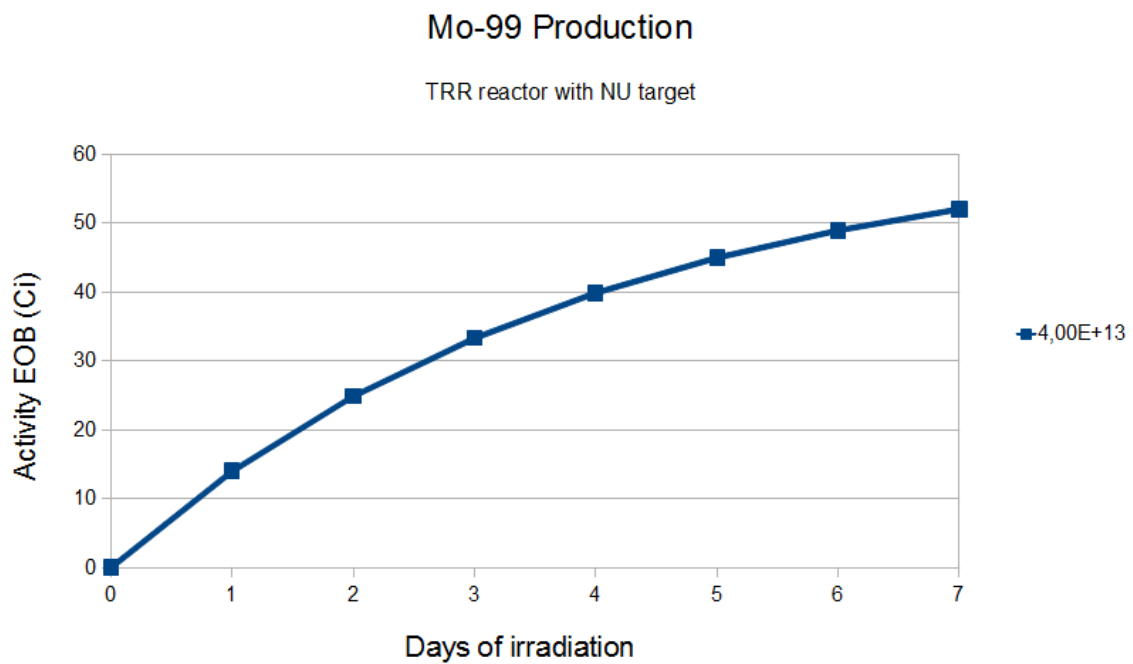

Figure 7-1. The activity of  $^{99}\text{Mo}$  as a function of irradiation time.



Figure 7-2. An Iranian-produced technetium generator displayed by the AEOI during the 55th Annual Regular Session of the IAEA General Conference in Vienna 2011. (Photo: Halvor Kippe.)

### 7.3.2 Radioisotope production at the IR-40 reactor

The IAEA has raised questions regarding the radioisotope production intended at the IR-40 compound. When the IAEA received the initial drawings for the IR-40 reactor in 2003, there were no references to hot cells, which are an essential part of radioisotope production. Iran later explained that they did not have detailed information about the dimensions or the actual layout of the hot cells, because they did not know the characteristics of the manipulators<sup>15</sup> and the lead shielded windows [16].

In 2010, the IAEA conducted a design information verification<sup>16</sup> (DIV) visit at the IR-40 compound. Inspection of the radiochemistry building revealed that concrete structures for hot cells were now in place, but no hot cell windows or manipulators were present [24].

Iran has trouble procuring equipment for handling radioactive materials from abroad due to export control restrictions. They are therefore considering producing such equipment domestically [23].

---

<sup>15</sup> Manipulators are remotely controlled robotic arms, enabling an operator to handle highly radioactive materials behind heavy shielding.

<sup>16</sup> Regular IAEA inspections are either DIVs or a so-called *Physical Inventory Verification* (PIV). The purpose of a DIV is to verify that a facility is constructed and/or operated as declared, while a PIV is a material accountancy undertaking, to ensure the non-diversion of declared nuclear materials.

## 8 The IR-40 heavy water research reactor

Historically, several heavy water research reactors fueled with natural uranium have been used to produce plutonium for nuclear weapons [37].

If the IR-40 reactor could be converted to a more proliferation-resistant reactor, the concern of Iran being able to produce significant quantities of weapons-grade plutonium would be reduced.

In this chapter, we compile available information on the IR-40 reactor. As this information is incomplete or contradictory, we estimate and deduce possible IR-40 reactor designs using reactor physics theory and information provided on other similar reactors.

### 8.1 IR-40 specifications

There is not much information about the IR-40 reactor in the public domain. Some official information on IR-40 is presented by the Iranian authorities, and some information is released by the IAEA following DIV visits to the reactor [53]. But only safeguards-relevant information is supposed to be reported by the IAEA in its reports, so most of the design characteristics of the reactor are not available to the public.

The first official information provided by Iran on the IR-40 reactor was that in order to create a neutron flux sufficiently large for viable radioisotope production, the reactor should have a neutron flux of  $10^{13}$ - $10^{14}$  neutrons/cm<sup>2</sup> · s, based on a power output of 30-40 MW<sub>th</sub>. Iran later stated that the thermal output is aimed at 40 MW<sub>th</sub>. The fuel is reported to be natural uranium dioxide,  $NUO_2$ , and the cladding is to be indigenously produced Zircaloy [16].

In 2010, IAEA reported that the pressurizer for the reactor cooling system and heavy lifting crane were installed [23;25]. The existence of a pressurizer could mean that the moderator or coolant or both are going to be pressurized. This hypothesis was strengthened when the IAEA in 2011 reported on the installation of a separate cooling and moderating system [22]. This means that the coolant and moderator may be in different circuits, such as in CANDU and RBMK reactors.

Figure 8-1 shows a satellite image of the IR-40 reactor and its surrounding support structures. The reactor will be located inside the concrete dome in the middle of the image.



*Figure 8-1. An overview of the IR-40 complex with the reactor located under the concrete dome in the center, and mechanical draft cooling towers in the lower right hand corner [70].*

## **8.2 Origin of the IR-40 design**

Iran has stated that the design of the IR-40 reactor is indigenous, but that they have consulted with foreign experts on some parts of the reactor design [16]. The following will substantiate the scope of foreign assistance.

### **8.2.1 Russian origin**

In 2009, Iranian authorities displayed a fuel assembly reportedly intended for the IR-40 reactor. The fuel assembly is shown Figure 8-2, and strongly resembles an RBMK fuel assembly. *The Institute for Science and International Security*, an independent non-governmental organization, received information that confirms that RBMK-type fuel is indeed intended for the IR-40 reactor. Iran allegedly received assistance from Russian firms in modifying the RBMK design to fit the IR-40 core [71;72].

If the IR-40 reactor is meant to be a pure  $D_2O$  moderated and cooled reactor, the choice of an RBMK fuel assembly is odd. Up to this date, RBMK assemblies have been used exclusively in reactors moderated by graphite and cooled by light water [29]. But combined with the IAEA report of separate coolant and moderator heat exchangers, it supports the idea that that the IR-40 reactor will employ pressure tubes [22]. This would be a feasible solution for

Iran, because RBMK fuel has been used for over 40 years and is thus a proven pressure tube design, although it has never before been used in a HWR.

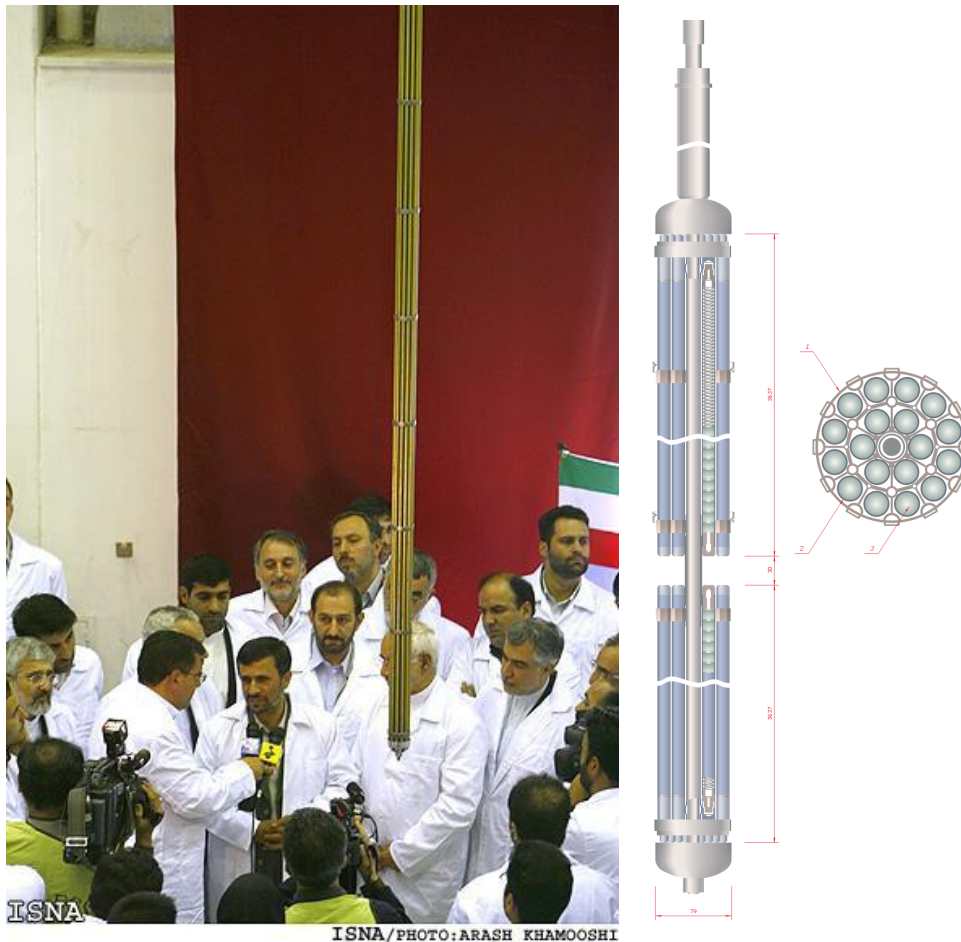

Figure 8-2. Left. President Mahmoud Ahmadinejad interviewed next to an RBMK-resembling fuel assembly in the spring of 2009 [73]. Right. A graphical representation of an RBMK fuel assembly. The fuel assembly is composed of two concentric circles of fuel rods and a central support rod [74].

In a brochure presenting the nuclear industry in Iran published by the AEOI in 2011, an RBMK-resembling fuel element is displayed, see Figure 8-3 [21]. The brochure informs that the Fuel Manufacturing Plant (FMP) in Esfahan will produce fuel for the IR-40 and Bushehr reactor, but the Bushehr reactor uses hexagonally shaped fuel assemblies, so the fuel assembly on display must be intended for the IR-40 reactor. Moreover, the Bushehr reactor will receive fuel from Russia in its first 20 years of operation [5]. By counting the fuel rods in Figure 8-3, it seems that the assembly contains 18 fuel rods such as the original RBMK assembly. The specifications for two different RBMK fuel assemblies are given in Table 8-1.

A standard RBMK assembly is 10 meters long and consists of two vertical fuel regions [75]. If RBMK assemblies are intended for use in the IR-40 core, the modification assistance Iran



received from Russia would likely consist of modifying the fuel assembly so it only contains one of the two vertical fuel regions, because the reactor core of the IR-40 necessarily will be much smaller than the reactor core of a typical RBMK reactor.



*Figure 8-3. An RBMK-resembling fuel assembly displayed in a brochure from the AEOI about the nuclear industry in Iran [21].*

A possible reason for Iran to choose a design which employs pressure tubes, is because this would place fewer restrictions on the pressure vessel surrounding the reactor core, thus making the pressure vessel easier for Iran to manufacture indigenously. A pressure tube design would also provide valuable training and information if Iran decides to build CANDU- or RBMK-type reactors in the future. As Iran has limited indigenously uranium deposits [5], CANDU reactors could use these resources more efficiently than LWRs [76].

	RBMK – 1000	RBMK – 1500
Fuel type	UO <sub>2</sub> + Er <sup>17</sup> (2.6% U-235)	UO <sub>2</sub> + Er (2.6% U-235)
Assembly geometry	Circular array	Circular array
Number of rods per assembly	37	37
Fueled	36	36
Unfueled	1	1
Overall assembly length (mm)	10014	10014
Overall assembly width (mm)	79	79
Rod length (mm)	3640	3640
Active fuel length (mm)	3410	3410
Rod outside diameter (mm)	13.63	13.63
Pellet length (mm)	12-15	12-15
Pellet outside diameter (mm)	11.48	11.48
Pellet density (g/cm <sup>3</sup> )	10.4 – 10.7	10.4 – 10.7
Average linear fuel rating (kW/m)	15.3	20.5
Peak linear fuel rating (kW/m)	35	42.5
Clad material	Zr1%Nb	Zr1%Nb
Clad thickness (mm)	0.85	0.85
Average discharge burnup (GWd/tU)	25.8	26
Maximum assembly burnup (GWd/tU)	29.6	30
Initial pressure of gases in the fresh fuel rod	0.5 MPa	0.5 MPa

Table 8-1. Specifications of RBMK-1000 and RBMK-1500 fuel assemblies [77;78].

### 8.3 Estimating the dimensions of the IR-40 reactor

Before discussing the feasibility of modifying the IR-40 reactor, we need to know more about the current reactor being constructed. Different approaches of estimating the dimensions of the IR-40 reactor have been employed.

#### 8.3.1 Energy density comparison

One method of estimating the size of the IR-40's core is by comparing the energy density of similar HWRs, and assuming the same energy density for the IR-40 core. Power per volume varies only slightly from reactor to reactor [79]. Table 8-2 shows the dimensions and energy densities of reactors thought to share some characteristics with the IR-40 reactor.

---

<sup>17</sup> Erbium is added to the fuel as a burnable neutron poison.



<b>Reactor</b>	Dhruva	National Research Universal (NRU)
<b>Country</b>	India	Canada
<b>Dimensions</b>	3.72 m (D), 3.87 m (H) = 42.1 m <sup>3</sup>	3.5 m (D), 3.7 m (H) = 35.6 m <sup>3</sup>
<b>Thermal output</b>	100 MW	135 MW
<b>Energy density</b> <i>MW<sub>th</sub>/m<sup>3</sup></i>	2.38	3.79
<b>Fuel type</b>	Natural metallic uranium	19 % LEU Al-U <sub>3</sub> Si

Table 8-2. Energy densities of selected HWRs [80],[81] [82;83].

If Iran utilizes natural uranium, such as the Dhruva reactor, the IR-40 reactor will have an energy density of about 2.38 MW<sub>th</sub>/m<sup>3</sup>. Using the energy density and the known thermal output of the IR-40 reactor, we can estimate the volume of the core:

$$\text{Core volume} = \frac{\text{Thermal power}}{\text{Energy density}} = \frac{40 \text{ MW}_{th}}{2.38 \text{ MW}_{th}/\text{m}^3} = 16.8 \text{ m}^3$$

This is about half the volume of the NRU and Dhruva reactors, which have approximately three and two times the thermal output of IR-40, respectively.

The NRU and Dhruva reactors are cylindrical reactors with a height-to-radius ratio of 1:2.1. If we assume the same ratio for a cylindrical IR-40 core, the reactor will have a core height of 2.87 meters and a core diameter of 2.73 meters.

### 8.3.2 Similar reactors

Information on four different heavy water research reactors has been collected in Table 8-3. It may be possible to deduce characteristics on the IR-40 reactor by examining similar reactors.

<b>Reactor</b>	Dhruva	HWRR-2	El Salam	NRU
<b>Country</b>	India	China	Algeria	Canada
<b>Thermal power (MW)</b>	100	15	15	135
<b>Fuel</b>	Natural uranium metal	3% LEU Uranium dioxide	3% LEU	Ca 19% Al-U <sub>3</sub> Si LEU
<b>Weight of fuel (t)</b>	6.35	-	0.9	-
<b>Core size (m)</b>	3.72 (D) x 3.87 (H)	-	-	3.5 (D) x 3.7 (H)
<b>Lattice pitch (cm)</b>	18			19.7
<b>Lattice type</b>	Square lattice			Hexagonal array
<b>Fuel configuration</b>	7 fuel rods per assembly		12 fuel rods per assembly	12 fuel rods per assembly
<b>Fuel cladding</b>	Aluminum	Zircaloy	Zircaloy	Aluminum alloy
<b>Fuel sites</b>	127		72	90
<b>Active length of fuel rods (cm)</b>				275
<b>Maximum thermal neutron flux (neutrons/cm<sup>2</sup> · s)</b>	$1.8 \times 10^{14}$	$2.6 \times 10^{14}$	$2.1 \times 10^{14}$	$3 - 4 \times 10^{14}$
<b>Moderator</b>	D <sub>2</sub> O	D <sub>2</sub> O	D <sub>2</sub> O	D <sub>2</sub> O
<b>Coolant</b>	D <sub>2</sub> O	D <sub>2</sub> O	D <sub>2</sub> O	D <sub>2</sub> O
<b>Reflector</b>	D <sub>2</sub> O	D <sub>2</sub> O and graphite	D <sub>2</sub> O and graphite	D <sub>2</sub> O

Table 8-3. Data from heavy water research reactors [80;81] [84-86] [82;83;87-92] .

### 8.3.3 RBMK dimensions

If modified RBMK fuel assemblies are intended for the IR-40 reactor, the dimensions of the assembly would give an indication of the height of the reactor core. Information about RBMK fuel given in Table 8-1 states that the fuel rods have an active fuel height of 341 cm, and the total length of the fuel assembly is 364 cm. Assuming that the IR-40 core is cylindrical with a height-to-radius ratio of 1:2.1, the diameter of the core is 325 cm. This yields a core volume of 28.2 m<sup>3</sup>. This is 11 m<sup>3</sup> larger than the volume found from the energy density comparison in 8.3.1.

By looking at the lattice pitches for different reactors in Table 8-3, it is possible to determine how many fuel assemblies can fit inside the reactor core with the dimensions given by the RBMK assembly. One assembly occupies an area fanned out by the lattice pitch. The number

of fuel assemblies which can fit inside the core can be estimated by dividing the bottom area of the core with the area one assembly occupies.

A hexagonal lattice pitch of 19.7 cm, such as in the NRU, results in 246 fuel assemblies, while a square lattice of 18 cm, such as in the Dhruva reactor, will result in 259 fuel assemblies. If each assembly consists of 18 fuel rods with an  $\text{UO}_2$  density of  $10.4 \text{ g/cm}^3$ , this yields a core with a mass of 16 tons and 17 tons of  $\text{UO}_2$ , respectively. See Appendix B for calculations.

It should, however, be noted that this number of assemblies is 2.5 and 2 times higher than for NRU and Dhruva reactors. In order to get a value that closer resembles the number of assemblies in NRU and Dhruva, the lattice pitch for the IR-40 core would have to be larger than in NRU and Dhruva.

### 8.3.4 Diffusion theory and buckling factor

It is possible to estimate the minimum size of the IR-40 core by assuming that it is a homogenous reactor and employing the diffusion theory from Chapter 3. This methodology was employed when designing the first generation of nuclear reactors [34].

There will be an error in the size of the IR-40 core since it is assumed that the IR-40 is a homogenous reactor. Homogenous reactors which employ up to 7 % enriched uranium will have a lower  $k_{eff}$  than a corresponding heterogeneous reactor [28;93].

By employing equations (17) and (19) we can insert data for a HWR fueled with NU and observe what fraction of heavy water and NU results in the smallest critical volume. Table 8-4 lists different calculated configurations of homogenous cylindrical HWRs assuming a height-to-radius ratio of 1:2.1. It uses diffusion data for heavy water and for a CANDU reactor. The calculations are presented in Appendix A.

Minimum size of IR-40 core based on diffusion theory				
	Bare HWR core	Reflected HWR core	Bare HWR core	Reflected HWR core
Diffusion data	Pure moderator	Pure moderator	CANDU	CANDU
Dimensions (m)	D = 2.6, H = 2.73	D=0.62, H =0.75	D = 1.63, H = 1.71	D = 1.44, H = 1.33
Volume (m <sup>3</sup> )	14	0.25	3.57	1.62

Table 8-4. Size of the IR-40 core estimated using diffusion theory.

The data presented in Table 8-4 are the minimum sizes required for a bare and reflected reactor to go critical. For the reactor to operate over time, it needs excess reactivity. Excess reactivity can be achieved by increasing the enrichment of the fuel or increase the size of the core. Since the IR-40 reactor will employ natural uranium, the dimensions of the reactor will have to be larger than found in Table 8-4 [27].

### 8.3.5 Satellite images

The satellite photograph in Figure 8-1 shows the IR-40 reactor and the surrounding support structures. It is possible to estimate the thermal output of the IR-40 reactor by looking at the outer dimensions of the heat dissipation system [94].

The heat dissipation system is located in the bottom right corner in Figure 8-1. It consists of four mechanical draft towers. An estimate for the heat dissipation capacity by mechanical draft towers is  $0.093 - 0.116 \text{ MW}_{\text{th}}/\text{m}^2$  [94]. Judging from the satellite image, the combined area of the draft towers is about  $11 \text{ m} \times 40 \text{ m}$ . This gives a cooling capacity of

$$P_{\text{cooling}} = 0.1 \text{ MW}/\text{m}^2 \cdot \text{area} = 0.1 \text{ MW}/\text{m}^2 \cdot 11 \text{ m} \cdot 40 \text{ m} = 44 \text{ MW}$$

This is in accordance with the thermal output which Iran has declared for the reactor [16].

Figure 8-1 also shows an opening in the concrete dome where the reactor is going to be located. The opening is probably used for bringing in large parts such as the pressure vessel. Using the measuring tool in Google Earth, the opening is estimated to be about 5-6 meters in diameter. The size of the opening puts an upper limit on the diameter of the pressure vessel to 5-6 meters, but it is difficult to estimate the dimensions of the reactor and its geometry just by this value alone [94].

### 8.3.6 Scientific publications

Iranian scientists have produced numerous articles on various subjects in nuclear physics and engineering [58;95-98]. Several articles describe an Iranian 40 MW HWR [95-97].

One article was published in Reliability Engineering & System Safety on Sciences Direct in 2007 [95]. The topic of the article is “*Level-1 probability safety assessment of the Iranian heavy water reactor using SAPHIRE software*” and is an evaluation of the safety of the *Iranian Heavy Water Research Reactor* (IHWRR). The article describes the IHWRR as a 40 MW HWR thermal tank-type reactor fueled with NU built for gaining experience and technical know-how on design and construction of non-power reactors, and for utilizing the reactor for activation, irradiation and radioisotope production.

The IHWRR is described to employ 150 fuel assemblies in a triangular lattice, with a lattice pitch of 265 mm. It is also equipped with eight vertical channels for radioisotope production and 27 control and protection channels. The control and protection channels include 3 control rod channels, 12 shimming rod channels, 6 emergency rod channels, 6 emergency light water channels and 1 channel for a reference specimen [95].

The IHWRR will make use of a two-circuit cooling system, operating at a temperature of  $70 \text{ }^\circ\text{C}$  and a pressure of about 0.28 MPa for the coolant and moderator. The coolant and the moderator will be in liquid phase and are not mixed [95].

A second article published in World Journal of Nuclear Science and Technology in 2011 describes a scenario where a Iranian 40 MW HWR is being converted to utilize light water as coolant and moderator and LEU hydride fuel [96]. The title of the article is “*Neutronic Analysis of Generic Heavy Water Research Reactor Core Parameters to Use Standard Hydride Fuel*”. The article refers to two previous articles describing the IHWRR 40 MW HWR [95;97]. It describes a core employing 150 fuel assemblies, where each assembly consists of 18 fuel rods with an active fuel region of 343 cm. The article also provides an illustration of the core configuration shown in Figure 8-4.

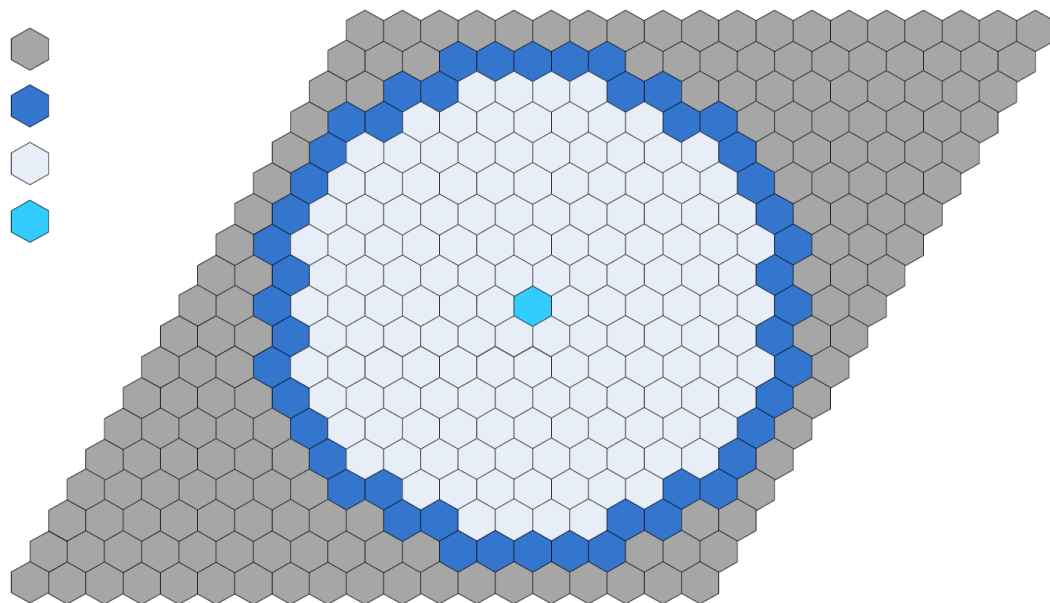

Figure 8-4. Setup of a 40 MW HWR core with Standard Hydride Fuel [96]. The color code is, dark gray: black absorber, blue: reflector, light blue: fuel assemblies, cyan: light water [99]. The article does not describe what a black absorber is.

By looking at Figure 8-4, the diameter of the core is found by counting the fuel positions in the core. There are 13 positions across the middle of the core. The diameter of one position is equal to the lattice pitch of 26.5 cm. This gives a core radius of 344 cm, but since the fuel assemblies are located in the middle of the hexagons in Figure 8-4, one lattice pitch length is removed to account for the edge of the core and the diameter becomes 318 cm. This gives a height-to-radius ratio of 2.16 and a core volume of 27.3 m<sup>3</sup>. This is similar to the data found if it was assumed that the IR-40 reactor employed RBMK type fuel, see Chapter 8.3.3.

The specifications provided by the two articles [95;96] are combined in Table 8-5.

40 MW HWR	
Total thermal power (MW)	40
Power absorbed by the coolant (MW)	37
Power absorbed by the moderator (MW)	3
Lattice pitch (cm)	26.5
Temperature coolant (°C)	70
Temperature moderator (°C)	70
Number of fuel rods each per assembly	18
Number of fuel assembly	150
Pressure in coolant and moderator (MPa)	0.28
Active fuel assembly length (cm)	343

Table 8-5. 40 MW HWR specifications [95;96].

#### 8.4 A possible IR-40 design

Different methods have been used to estimate the characteristics and dimensions of the IR-40 reactor.

The physical size of the core is estimated by diffusion theory to be a minimum of 0.25 m<sup>3</sup>, while the satellite photograph of the IR-40 compound gives a maximum diameter of 5-6 meters for a pressure vessel which can fit into the opening of the IR-40 concrete dome. The energy density comparison with similar HWRs resulted in a core volume of 16.8 m<sup>3</sup>. From these estimates, 16.8 m<sup>3</sup> is more in line with the volume of similar HWR research reactors listed in Table 8-3. Even though the energy density comparison estimate is a crude estimate, it is probably better because it has much fewer variables and sources for error than the diffusion theory estimate.

The information released by the IAEA hints at a reactor design where the IR-40 reactor will employ separate cooling and moderating circuits. This information is strengthened by the fuel assembly displayed by Iranian authorities which closely resembles an RBMK-assembly, normally used in reactors with separate cooling and moderating circuits.

If RBMK-type fuel with original specifications is used in the IR-40 reactor, the height of the core becomes 3.43 meter, while the diameter is 3.25 meter. This yields a core volume of 28.3 m<sup>3</sup>.

The two Iranian articles which an indigenous 40 MW HWR support the information released by the IAEA [96]. They describe a separate cooling and moderating system and present fuel assemblies with very similar dimensions of RBMK. It is therefore reasonable to assume that the reactor described in the two Iranian articles is in fact the IR-40 reactor.

## 9 Modeling and modification of the IR-40 reactor

The information gathered on the IR-40 reactor in Chapter 8 outlines the main properties of the reactor and makes it feasible to construct a computer model of the reactor. The model can be used to determine if the information regarding the reactor is valid and to evaluate possible modifications of the reactor.

To model the reactor, the software package, Standardized Computer Analyses for Licensing Evaluation version 6.1 (*SCALE 6.1*) from *Oak Ridge National Laboratory*, Tennessee, USA has been employed. SCALE is a *Monte Carlo* based computer code used for simulating different nuclear reactor cores, enabling important factors such as  $k_{eff}$ , decay heat, isotopic activity and core inventory to be computed [100]. SCALE is widely used and accepted around the world for criticality safety analysis [101].

### 9.1 Monte Carlo methods

Neutron transport through matter can be formulated as a stochastic process. There is a certain chance that a neutron will undergo a collision while traveling a certain distance. Any possible outcome of that collision has a certain probability, given by the respective cross sections. It will either scatter, be absorbed or initiate a fission.

A class of methods for simulating neutron transport through stochastic means is the so-called *Monte Carlo method* [102]. Monte Carlo analysis involves two steps. The first step is to generate neutron case histories by computer simulation, and the second step is to sample those histories in a quasi-random manner (hence the reference to Monte Carlo) to obtain estimates of the neutron flux [103]. The Monte Carlo method was invented by scientists working on the Manhattan Project.

### 9.2 SCALE

To operate, SCALE receives information about the materials and geometries for the specific problem from the user. The input parameters are given through *GeeWiz*<sup>18</sup> and/or *Notepad*. The input is used by SCALE to perform a problem-dependent cross-section processing to get the correct cross sections [104]. Data libraries containing extensive information on cross sections for nuclei at different neutron energies and temperatures are employed [105]. The cross section data is then used to solve the neutron transport equation.

To get a stable  $k_{eff}$ , many neutron histories must be computed. In the two modules used, this is achieved by choosing many neutron generations and neutrons per generation. The default

---

<sup>18</sup> Graphically Enhanced Editing Wizard. GeeWiz is a graphical user interface to make input and modeling easier in SCALE.

setting in SCALE is to compute 203 generations where the first 3 are skipped, where each generation consists of 1000 neutrons. This results in 200 000 neutron histories. For production calculation, SCALE routinely runs at least 1000 neutron histories with 10000 neutrons per generation, resulting in 10 million neutron histories [106]. To save some computing time, the models of the IR-40 reactor were run with 0.5 – 1 million neutron histories, which was sufficient for achieving a stable  $k_{eff}$ .

Two different modules in SCALE were used to model the IR-40 reactor.

### 9.2.1 CSAS6

*Criticality Safety Analysis Sequence 6* (CSAS6) is a control module in SCALE that calculates the  $k_{eff}$  via KENO-VI. KENO-VI is a 3-D multi-group Monte Carlo method which solves the Boltzmann neutron transport equation [107].

The flow chart of CSAS6 is illustrated in Figure 9-1. The input provided by the user, in form of geometry and composition, is used by CSAS6 to perform a problem-dependent multi-group cross-section processing. The cross section data is sent to KENO-VI which solves the neutron transport equation and calculates a  $k_{eff}$  for the 3-D-system

It is possible to visualize the input geometry in 3-D using KENO3D which is coupled to KENO-VI [101].

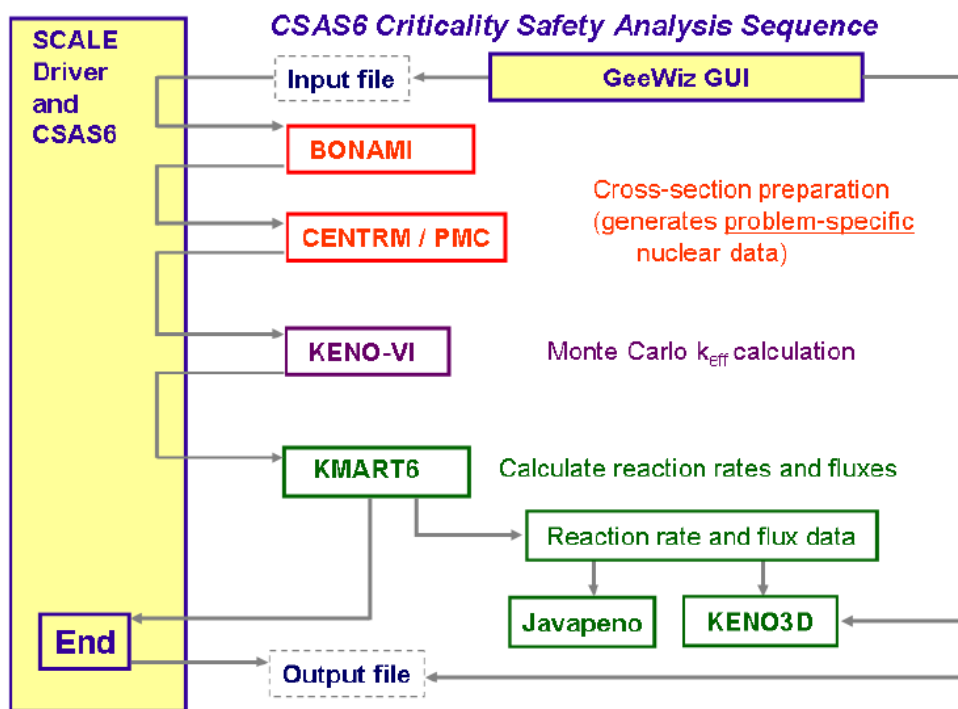

Figure 9-1. The flow chart of a CSAS6 sequence [101].



## 9.2.2 TRITON

*Transport Rigor Implemented with Time-dependent Operation for Neutronic depletion* (TRITON) is a multipurpose SCALE control module for transport, depletion and sensitivity and uncertainty analysis [108]. The depletion calculations can be used to predict isotopic concentrations, source terms, and decay heat in spent fuel.

In TRITON the input provided by the user is used to calculate multigroup cross sections for KENO-VI, which is coupled with ORGIEN-S for depletion calculations. ORGIEN-S or *Oak Ridge Isotope Generation code* explicitly simulates 1484 unique nuclides during depletion calculation [109].

TRITON may solve the transport equation for 2-D arbitrary configurations, or 3-D using KENO-VI. By using KENO-VI it is possible to visualize the input in KENO3D as in the CSAS6 module.

Figure 9-2 shows a flow chart of the TRITON sequence using KENO-VI.

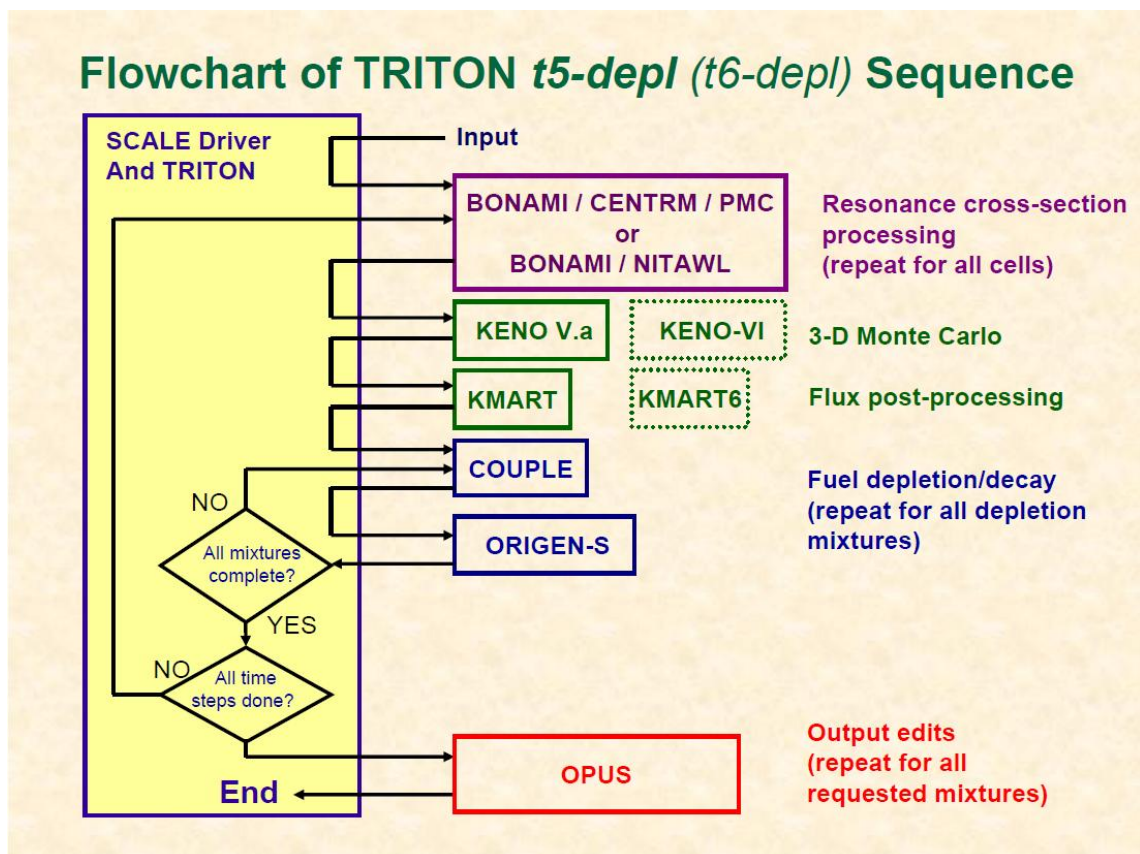

Figure 9-2. The flow chart of a TRITON depletion sequence [109].

### 9.3 IR-40 reactor fueled by natural uranium

The input parameters for a model of the IR-40 fueled with NU are based on the calculations, assessments and available information on the IR-40 reactor obtained in Chapter 8.

The model assumes that the IR-40 reactor is a *pressurized heavy water reactor* (PHWR) which employs RBMK fuel assemblies in a *hexagonal lattice*. Each fuel assembly is located in a pressure tube made out of Zircaloy. Both pressure tubes and the pressure vessel are filled by *reactor-grade heavy water*<sup>19</sup>. An approximation is made in modeling the fuel rods as long solid UO<sub>2</sub> rods instead of many individual fuel pellets stacked on top of each other. The specifications for the entire model are listed in Table 9-1, and the input files for SCALE are located in Appendix C.

The fuel assembly for the IR-40 model is illustrated in Figure 9-3. The core configuration and surrounding pressure vessel is illustrated in Figure 9-4 and Figure 9-5.

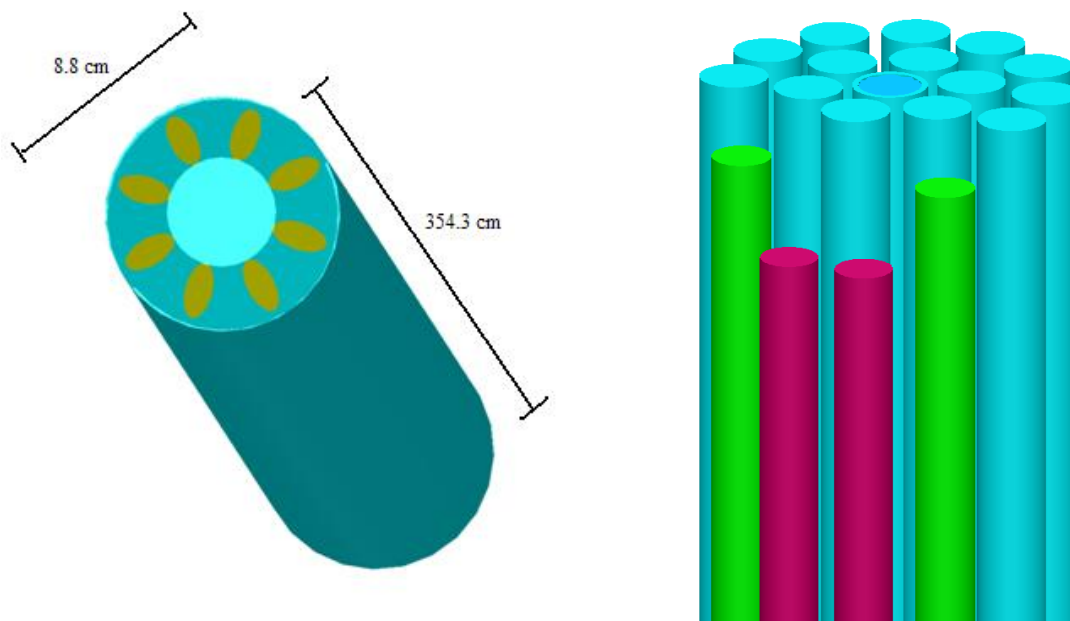
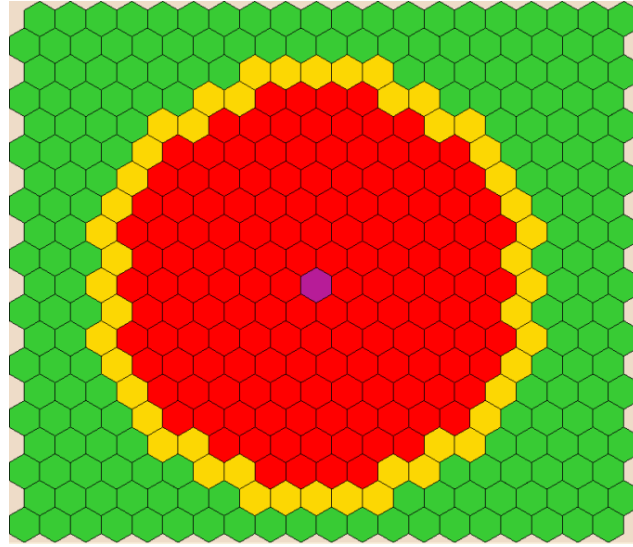

Figure 9-3. A model of the fuel assembly used in the IR-40 reactor, produced by KENO3D. The figure to the left shows the end plug of the fuel assembly. Yellow is D<sub>2</sub>O while cyan is Zircaloy. The figure to the right shows 18 fuel pins arranged inside an assembly. The four fuel rods in the front have had their cladding removed for illustrative purposes. Zircaloy is shown in cyan, helium in green, UO<sub>2</sub> in red and nitrogen in blue. The central rod is a hollow Zircaloy rod filled with nitrogen.

---

<sup>19</sup> Reactor-grade D<sub>2</sub>O contains at least 99.75 % D<sub>2</sub>O by weight, the rest being light water [38].



*Figure 9-4. An overview of the GeeWiz model of the IR-40 core. Hexagons containing only  $D_2O$  are shown in green, yellow hexagons contain empty pressure tubes filled and surrounded by  $D_2O$ , red hexagons are fuel assemblies, and the purple hexagon is an aluminum rod surrounded by  $D_2O$  for measuring the neutron flux.*

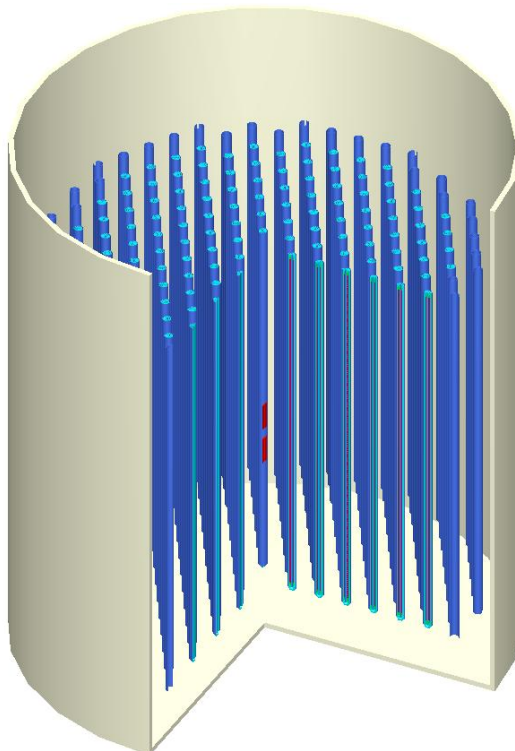

*Figure 9-5. The view of the reactor produced by KENO3D with  $D_2O$  and the top of the pressure vessel removed for illustrative purposes. The blue are fuel assemblies, gray is the pressure vessel and the red are aluminum rods for flux measurement.*

IR – 40 reactor fueled with naturally enriched UO <sub>2</sub>	
Thermal output (MW)	40
Power absorbed by the coolant (MW)	37
Power absorbed by the moderator (MW)	3
Moderator / coolant	D <sub>2</sub> O
Reflector	D <sub>2</sub> O
Temperature coolant (°C)	70
Temperature moderator (°C)	70
D <sub>2</sub> O purity (%)	99.75
Lattice pitch (cm)	26.5
Lattice configuration	Hexagonal
Number of assemblies	150
Pressure in reactor (MPa)	0.28
Fuel type (0.72 % U-235)	UO <sub>2</sub>
Fuel radius (cm)	0.574
Clad radius (cm)	0.6815
Pellet density (g/cm <sup>3</sup> )	10.4
Assembly geometry	Circular array
Number of rods per assembly	19
Fueled	18
Unfueled	1
Overall assembly width (cm)	7.9
Rod length (cm)	350
Active fuel length (cm)	340
Outer diameter of pressure tube (cm)	4.4
Inner diameter of pressure tube (cm)	4.0

Table 9-1. Specifications for the IR-40 reactor based on estimates deduced in Chapter 8.

Using the dimensions in Table 9-1 the reactor has an active core 3.4 meters high and 3.2 meters in diameter. The core is placed in a 5 cm thick stainless steel vessel with a radius of 225 cm and a height of 500 cm. The core is surrounded by 50 cm of D<sub>2</sub>O under the core, 60 cm of D<sub>2</sub>O at the sides of the core and 110 cm over the core.

The geometry and the density of the proposed fuel yield a core with a mass of 10 tons of UO<sub>2</sub>, or a mass of uranium of 8.7 tons.

### 9.3.1 SCALE output

The model was first run in the CSAS6 module with 1 million neutron histories to test if the proposed design could go critical. KENO-VI estimated a  $k_{eff}$  of  $1.06313 \pm 0.00021$  for a fresh core without control rods. A lattice pitch of 20 cm was also tested, to check if the lattice pitch discussed in the Iranian publications was sound. The reduced lattice pitch gave a  $k_{eff}$  of 1.036, and the lattice pitch of 26.5 cm was therefore retained. A reduction of the

purity of D<sub>2</sub>O to 99 % was also tested in the TRITON module, but this resulted in a  $k_{eff}$  of 1.013 for a fresh core, and after 20 days of operation  $k_{eff}$  for the reactor fell under 1. This illustrates the importance of high purity of D<sub>2</sub>O for a NU fueled reactor.

The neutron flux in the reactor was computed by the TRITON module. The average thermal flux<sup>20</sup> in the fuel was estimated to  $1.8 \cdot 10^{13}$  neutrons/cm<sup>2</sup> · s, while the maximum thermal neutron flux in the centre of the core was calculated to  $1.3 \cdot 10^{14}$  neutrons/cm<sup>2</sup> · s. The maximum thermal flux is in the same order of magnitude as the HWRs listed in Table 8-3.

TRITON calculates a heavy metal mass of 8.5 tons for the core. It is unknown what causes a discrepancy of 200 kg of uranium between TRITON and the mass estimated from the dimensions and density of the fuel in 9.3.

### 9.3.2 Plutonium production

The TRITON module is used to estimate the accumulation of plutonium in the fuel rods. From Chapter 6 it is expected that the IR-40 reactor will produce significant quantities of WGPu. The production of plutonium in the IR-40 reactor in Chapter 6 was estimated to be 10.5 kg of WGPu after one year of operation with a capacity factor of 82 %. The TRITON simulation yields an annual production of 10 kg plutonium.

Figure 9-6 illustrates the amount of plutonium produced as a function of the specific burnup, while Figure 9-7 illustrates the percentage of the different plutonium isotopes present in the fuel as a function of specific burnup.

The graphs show that  $^{239}_{94}\text{Pu}$  is the most abundant plutonium isotope produced in the reactor, while  $^{240}_{94}\text{Pu}$  contribute to the mix gradually with increasing burnup. In order for the plutonium to be of super-grade (*i.e.* less than 2 % of  $^{240}_{94}\text{Pu}$  present), it should be extracted from the core after about three months of irradiation, corresponding to about 400 MWd/tU. If a lower quality (in terms of NWs potential) is acceptable (*i.e.* up to 6 % of  $^{240}_{94}\text{Pu}$  present) the core may produce plutonium for up till 270 days, corresponding to a burnup of 1242 MWd/tU.

If Iran can acquire an online fuel replacing mechanism, the pressure tube design allows them to extract irradiated fuel at any time. This would lead to a higher capacity factor and the option to extract fuel containing super-grade plutonium quality.

---

<sup>20</sup> Thermal neutrons in TRITON are neutrons having energy lower than 0.675 eV.

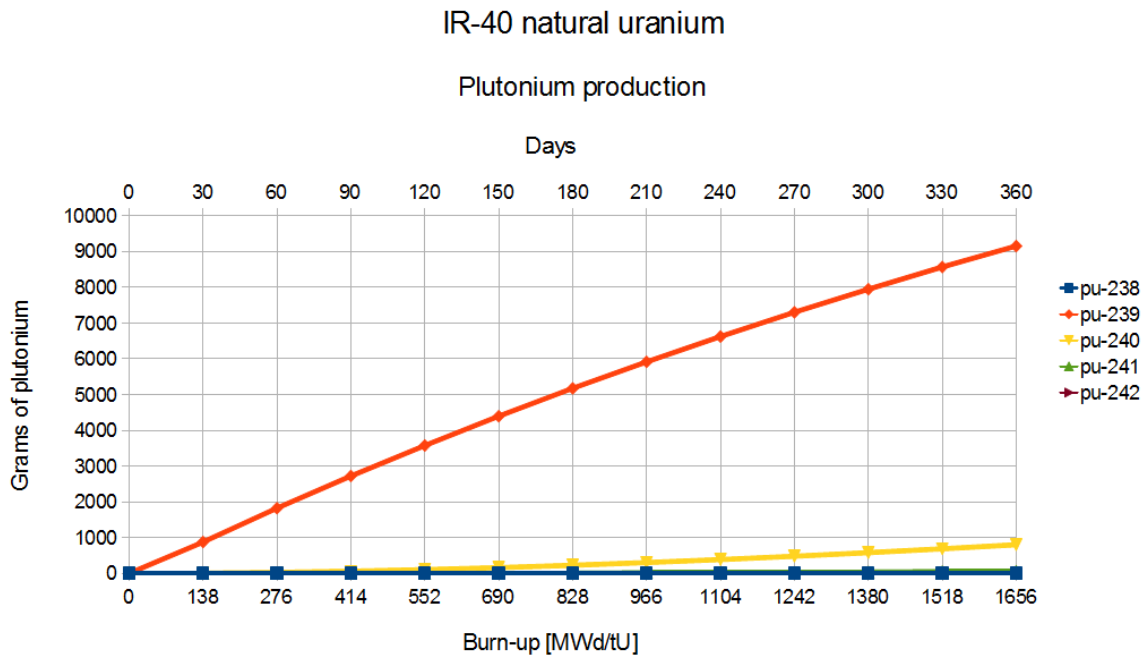

Figure 9-6. The mass of plutonium isotopes as a function of the specific burnup and operating time.

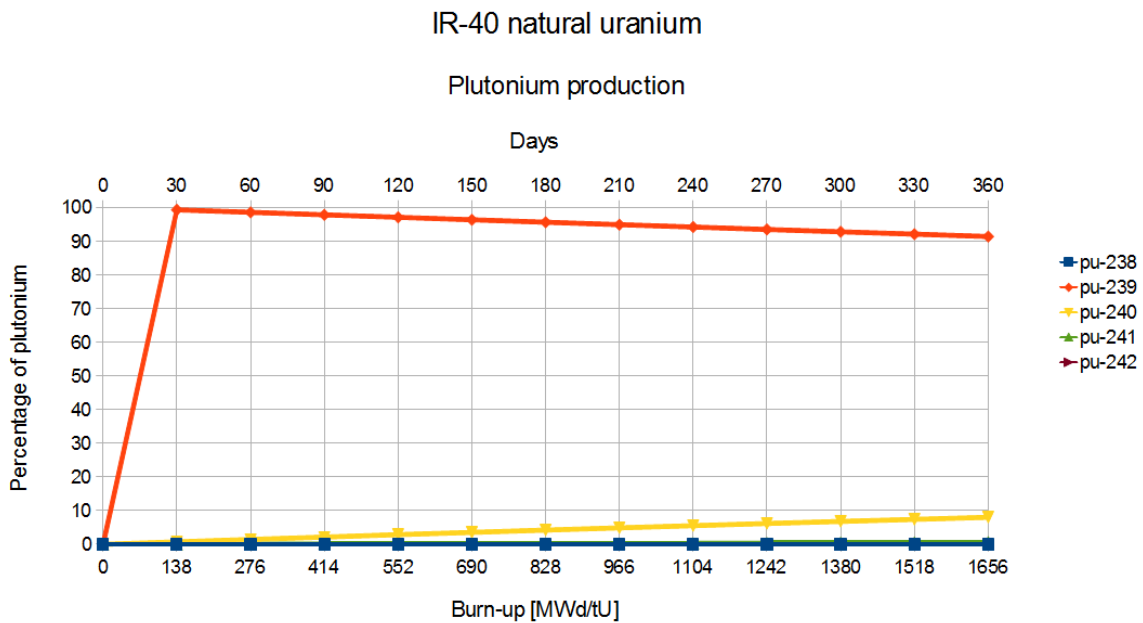

Figure 9-7. The mass of plutonium isotopes as a function of the specific burnup and operating time.

### 9.3.3 Radioisotope production

The TRITON module was used to estimate the potential for radioisotope production in the IR-40 core. To measure the feasibility for radioisotope production, the activity of  $^{99}\text{Mo}$  was measured in small uranium targets placed in the middle of the core. A high  $^{99}\text{Mo}$  activity would also mean a high activity of other radioisotopes [58].

The small uranium targets were placed in the purple position in Figure 9-4, in the middle of the core and irradiated. However TRITON calculated a thermal neutron flux of only  $10^{12}$  neutrons/cm<sup>2</sup> · s in the targets, and the resulting activity of  $^{99}\text{Mo}$  was much lower than expected.

Another approach was employed, this time placing mock targets made out of aluminum in the same position. The resulting flux in the middle of the core is now measured to  $1.0 - 1.4 \cdot 10^{14}$  neutrons/cm<sup>2</sup> · s, which is the same order of magnitude as is obtained in the OPAL and SAFARI reactors [56;57]. Because of cladding and self-shielding, the thermal neutron flux inside a uranium target used for radioisotope production will be lower than the flux measured in the aluminum rod [29].

Instead of using TRITON to measure the activity, equation (25) was used. The targets were assumed to be the pressed UO<sub>2</sub> targets described in [58]. Two targets were irradiated, one employing NU and a one 19.75 % LEU. The flux from TRR was provided as a reference, and compared to a thermal flux of  $5$  to  $10 \cdot 10^{13}$  neutrons/cm<sup>2</sup> · s. See Appendix C for calculations. Figure 9-8 and Figure 9-9 shows the activity in a target as a function of time of irradiation and thermal neutron flux. The two y axes show the activity after end of bombardment (EOB), and after six days of decay.

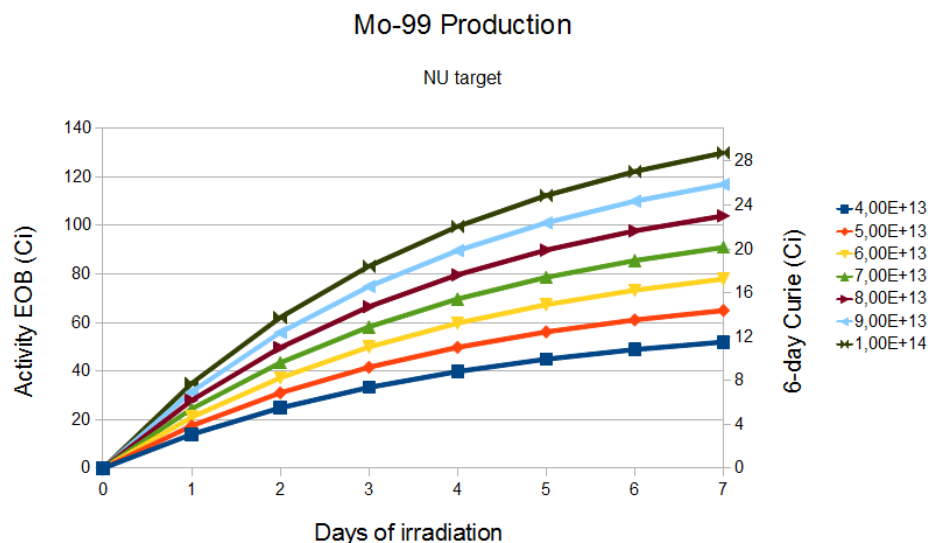

Figure 9-8. The activity as a function of time of irradiation and neutron flux.

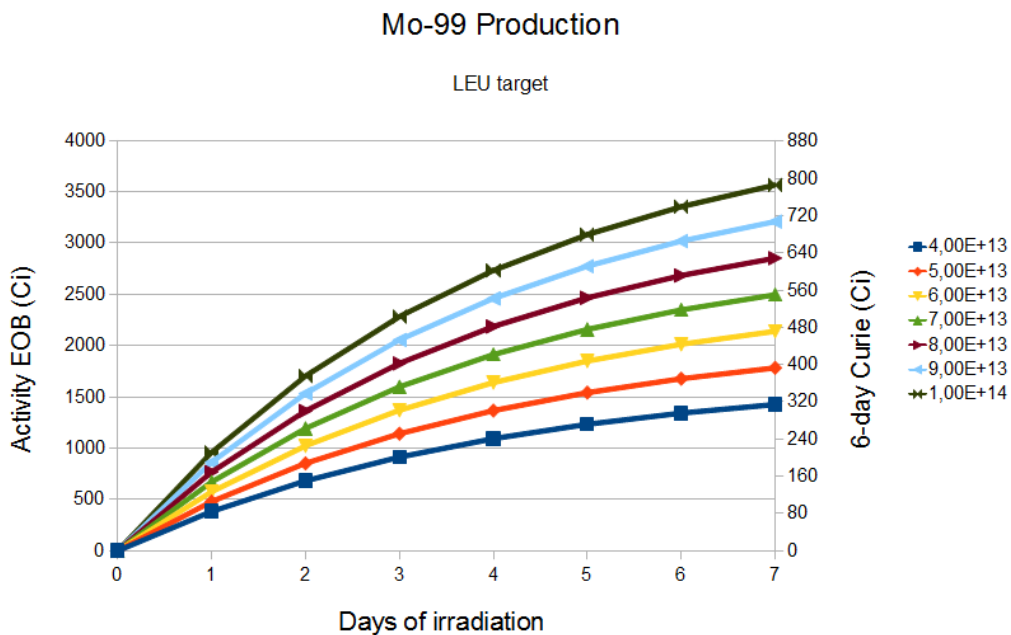

Figure 9-9. The activity as a function of time of irradiation and neutron flux.

A higher activity is obtained for the NU target in the IR-40 reactor compared to the TRR as a result of a higher thermal flux. But a much higher activity is obtained by using LEU instead of NU targets.

This illustrates that there is no need for Iran to produce HEU targets for production of  $^{99}\text{Mo}$ , as the activity provided by the NU exceeds Iran's 2002 demand for  $^{99}\text{Mo}$  of 20 Ci/week, while the LEU targets far exceeds Iran's  $^{99}\text{Mo}$  demand.

#### 9.4 Modified IR-40 reactor with LEU core

Olli Heinonen proposed converting the IR-40 reactor to employ LEU, thus reducing the stockpile of LEU in Iran [1]. To test if such a modification is possible, the information gathered on the IR-40 NU core is used to model a modified core. Various levels of enrichment are modeled to attempt to minimize the production of WGPu, while keeping the enrichment level too low for use in NWs [36]. Iran is known to master the technology required to produce LEU up to 19.75 % [18].

In order to make the modified core compatible with the current design parameters, as few changes as possible are made to the geometry of the reactor, the fuel assemblies and the pressure vessel. The pressure vessel is projected to be installed by 2011, and the fuel assemblies for the IR-40 reactor are being manufactured and tested. Therefore these parameters are assumed to be final [21;23].



The power output is held constant at the maximum of 40 MW, in order to maintain a high neutron flux. The use of enriched uranium enables a smaller and more compact core. The modified core is composed of 60 fuel assemblies and is illustrated in Figure 9-11. The specifications for the modified reactor are listed in Table 9-2.

IR – 40 fueled with LEU	
Thermal output (MW)	40
Power absorbed by the coolant (MW)	37
Power absorbed by the moderator (MW)	3
Moderator/coolant	D <sub>2</sub> O
Reflector	D <sub>2</sub> O
Temperature coolant (°C)	70
Temperature moderator (°C)	70
Heavy water purity (%)	99.75
Lattice pitch (cm)	26.5
Pressure in reactor (MPa)	0.28
Lattice configuration	Hexagonal
Assembly geometry	Circular array
Fuel type (5-15 % U-235)	UO <sub>2</sub>
Number of assemblies	60
Number of rods per assembly	19
Fueled	14
Unfueled	5
Overall assembly width (cm)	7.9
Rod length (cm)	364
Active fuel length (cm)	240
Fuel radius (cm)	0.574
Clad radius (cm)	0.6815
Pellet density (g/cm <sup>3</sup> )	10.4
Burnable absorber rods	Al <sub>2</sub> O <sub>3</sub> -B <sub>4</sub> C
Outer diameter of pressure tube (cm)	4.4
Inner diameter of pressure tube (cm)	4.0

Table 9-2. Specifications for a modified IR-40 reactor fueled with LEU.

#### 9.4.1 Fuel limitations

The use of LEU enables a smaller core and alters the way the fuel is cooled. Whereas 37 MW of heat in the original configuration was divided between 150 fuel assemblies (the last 3 MW being absorbed in the moderator), the same amount of heat is now divided between 60 assemblies.

From the information gathered on RBMK fuel in Table 8-1, the maximum power absorption for each fuel channel is 3 MW for an RBMK-1000 assembly and 4.25 MW for an RBMK-1500

assembly. Since the IR-40 reactor probably only employs half of an RBMK assembly (*i.e.* one fuel bundle instead of two in an assembly), it is assumed that maximum power absorption is also halved for each channel, and will therefore be in the range 1.5-2.12 MW [75]. Thus, each fuel channel should not be subjected to more than 1.5 MW.

RBMK fuel rods are operated at an average linear heat generation rate of 205 W/cm, and can withstand a maximum linear heat generation rate of 425 W/cm [78]. Taking these limitations into consideration, the fuel length of the modified core becomes 240 cm where each assembly consists of 14 fuel rods.

The modifications result in a core height-to-radius ratio of 1:2, an average linear heat rate of 198 W/cm, and maximum power absorption per channel of 666 kW. The increased heat generation per channel will demand an increased flow of D<sub>2</sub>O. See Appendix B for calculations. The mass of the fuel becomes 2.17 tons of UO<sub>2</sub> (1.9 tons of uranium).

The use of RBMK assemblies puts a limit on the average discharge burnup to 20-30 GWd/tU [78]. This limits the amount of time the fuel can spend in the reactor. Dividing the reactor power of 40 MW with the uranium content gives us a specific power of 21 MW/tU. If 25 GWd/tU is taken as an average, the modified fuel can stay in the core for

$$\text{Time of irradiation (days)} = \frac{25000 \text{ MWd/tU}}{21 \text{ MW/tU}} \approx 1200$$

The fuel rods can be irradiated for 1200 days, or 3 years and 120 days.

#### 9.4.2 SCALE output

The first SCALE calculation was run with 18 fuel rods enriched to 15 % without any reactivity-reducing counter measures. This resulted in a  $k_{eff}$  of over 1.5. To bring  $k_{eff}$  closer to unity, four fuel rods were replaced with rods made out of aluminum and boron carbide. The interior of the modified fuel assembly is illustrated in Figure 9-10. The whole reactor is illustrated in Figure 9-12.

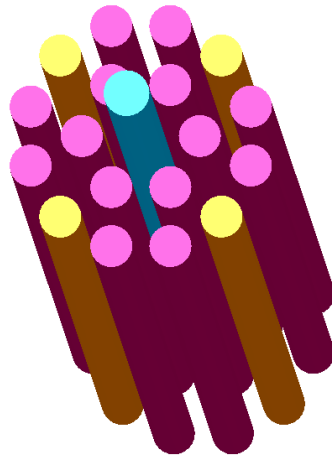

Figure 9-10. The interior of the modified fuel assembly produced by KENO3D. The  $UO_2$  rods are shown in pink, the aluminum-boron carbide rods in yellow and the central nitrogen filled rod in cyan.

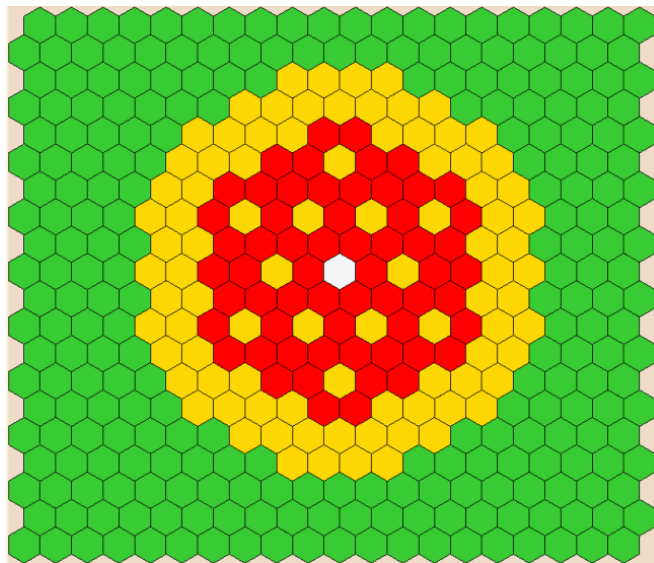
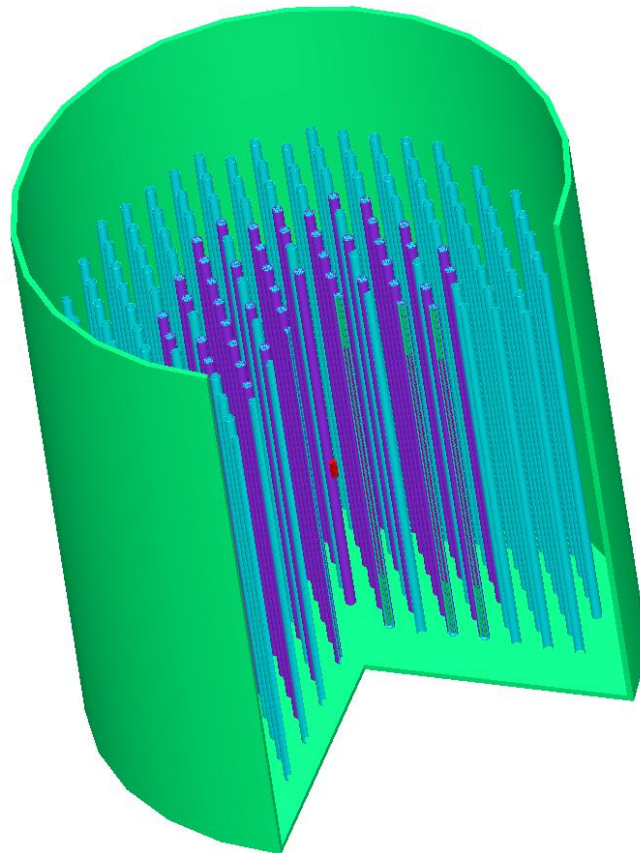

Figure 9-11. An overview of the GeeWiz model for the modified IR-40 core. Hexagons containing only  $D_2O$  are shown in green, yellow hexagons contain empty pressure tubes filled and surrounded by  $D_2O$ , red hexagons are fuel assemblies, and white is an aluminum rod used for measuring the neutron flux.



*Figure 9-12. An cut-out view of the modified IR-40 core generated by KENO3D. D<sub>2</sub>O and the top of the pressure vessel have been removed for illustrative purposes. The purple pressure tubes contain fuel, while the cyan pressure tubes are empty.*

#### 9.4.3 Plutonium production

The TRITON module was used to estimate the plutonium production in the modified core.

The reduced mass of the core will reduce the amount of plutonium produced. To compensate for this loss, it is possible to produce significant amounts of WGPu by placing a blanket of natural or depleted uranium around the core. However, under IAEA safeguards this would be virtually impossible without relatively rapid detection [110].

Different levels of enrichment were modeled to find out how much plutonium the reactor would produce, and what composition of plutonium isotopes this would give. The different plutonium compositions are shown in Table 9-3, while the amount of plutonium is shown in Table 9-4. The numbers are plotted in Figure 9-13 to Figure 9-18.

Enrichment	5 %			10 %			15 %		
	360	720	1200	360	720	1200	360	720	1200
U-235 burnup	18 %	35 %	57 %	9 %	19 %	30 %	6 %	13 %	21 %
Pu-238	0.04 %	0.11 %	0.28 %	0.03 %	0.08 %	0.20 %	0.01 %	0.04 %	0.10 %
Pu-239	92.32 %	84.02 %	72.43 %	96.03 %	91.84 %	85.84 %	99.12 %	96.45 %	92.72 %
Pu-240	6.92 %	13.64 %	22.38 %	3.64 %	7.13 %	11.76 %	0.86 %	3.22 %	6.29 %
Pu-241	0.69 %	2.03 %	4.08 %	0.30 %	0.91 %	2.05 %	0.02 %	0.28 %	0.85 %
Pu-242	0.03 %	0.19 %	0.82 %	0.01 %	0.04 %	0.16 %	0.00 %	0.00 %	0.03 %

Table 9-3. The different isotope compositions as a function of enrichment and burnup.

Enrichment	5%			10%			15%		
	360	720	1200	360	720	1200	360	720	1200
U-235 burnup	18 %	35 %	57 %	9 %	19 %	30 %	6 %	13 %	21 %
Pu-238	1	5	19	1	3	11	0	2	7
Pu-239	2453	3892	4806	1818	3289	4706	1480	2799	4249
Pu-240	184	632	1485	69	255	645	37	139	367
Pu-241	18	94	271	6	33	113	2	18	56
Pu-242	1	9	54	0	1	9	0	0	3
total [g]	2657	4631	6636	1893	3581	5483	1521	2958	4681

Table 9-4. The amounts of plutonium created as a function of enrichment and burnup.

The tables show that an enrichment of 5% yields plutonium with the lowest amount of  $^{239}_{94}\text{Pu}$ , but produces more plutonium than higher levels of enrichment. Fuel enriched to 15% produces 2 kg less plutonium than fuel enriched to 5% after 1200 days of operation, but nearly everything produced will be of weapons-grade quality.

The reason for the low amount of  $^{239}_{94}\text{Pu}$  in 15 % LEU is a result of a reduced neutron flux in the fuel rods. As 15 % enriched fuel has more fissionable material than 5 % enriched fuel, the flux must be lower for the same number of fissions and the amount of heat generated.

If the fuel rods could be irradiated for a longer period of time, the 15 % enriched fuel would end up with a less favorable mix of plutonium.

The fuel could be extracted from the reactor before the quality of plutonium is reduced, but repeated extraction of fuel, long before it should be extracted would raise suspicion at the IAEA.

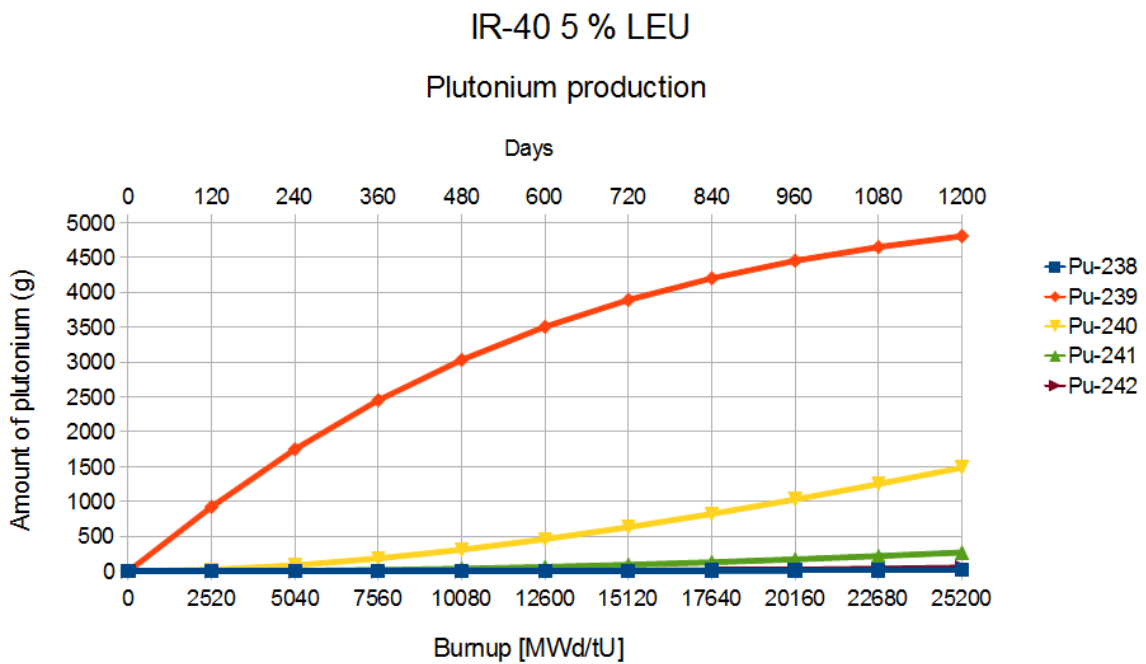

Figure 9-13. Plutonium production as a function of burnup and operation time at constant power.

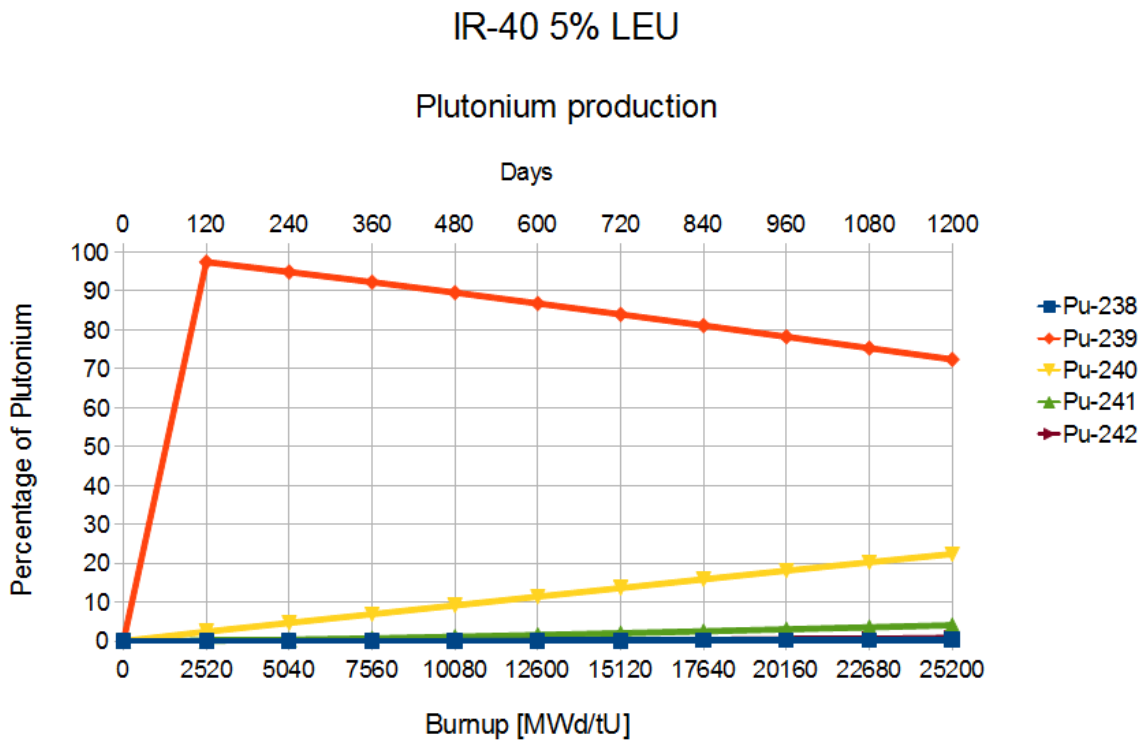

Figure 9-14. Plutonium production as a function of burnup and operation time at constant power.

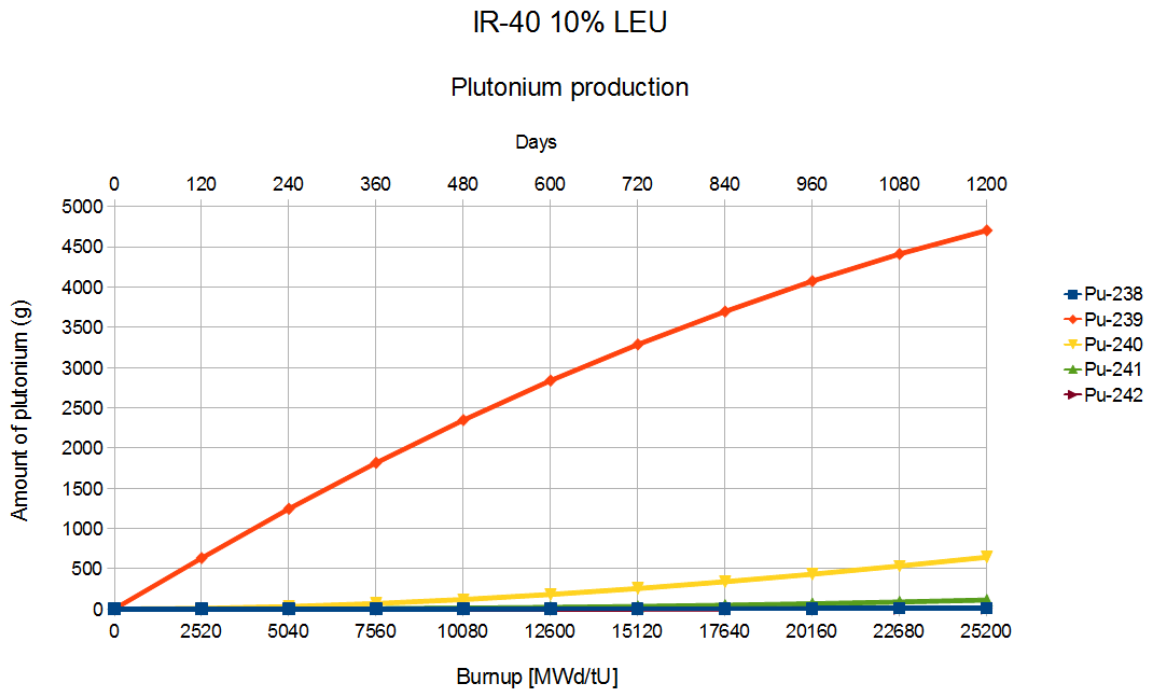

Figure 9-15. Plutonium production as a function of burnup and operation time at constant power.

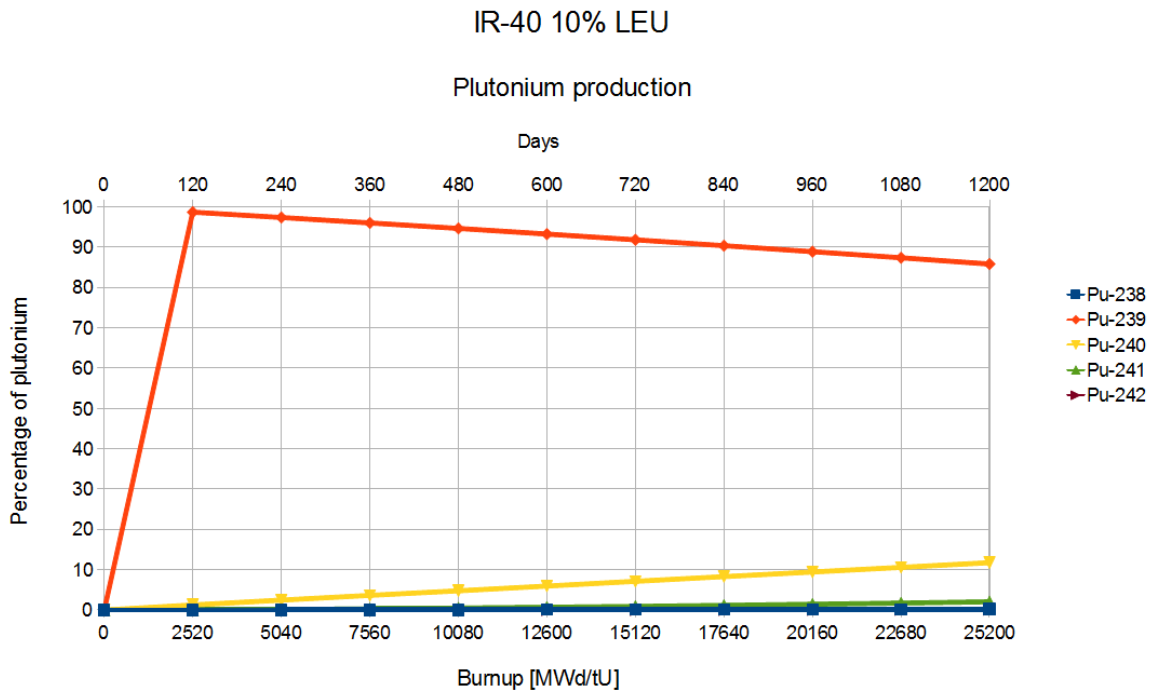

Figure 9-16. Plutonium production as a function of burnup and operation time at constant power.

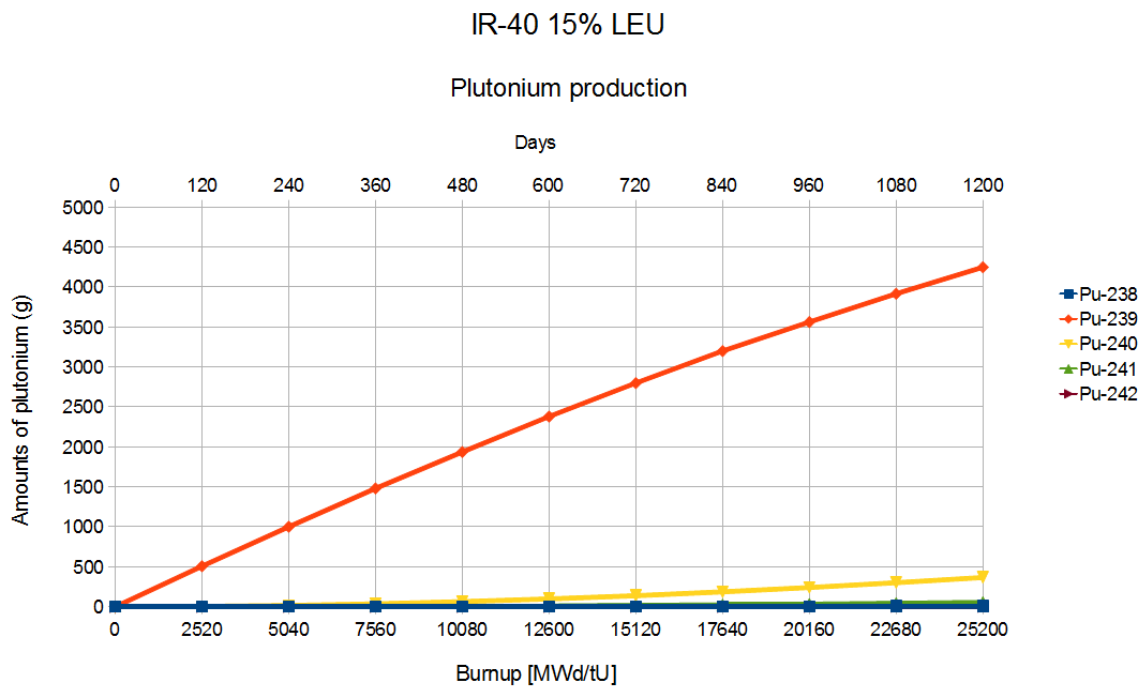

Figure 9-17. Plutonium production as a function of burnup and operation time at constant power.

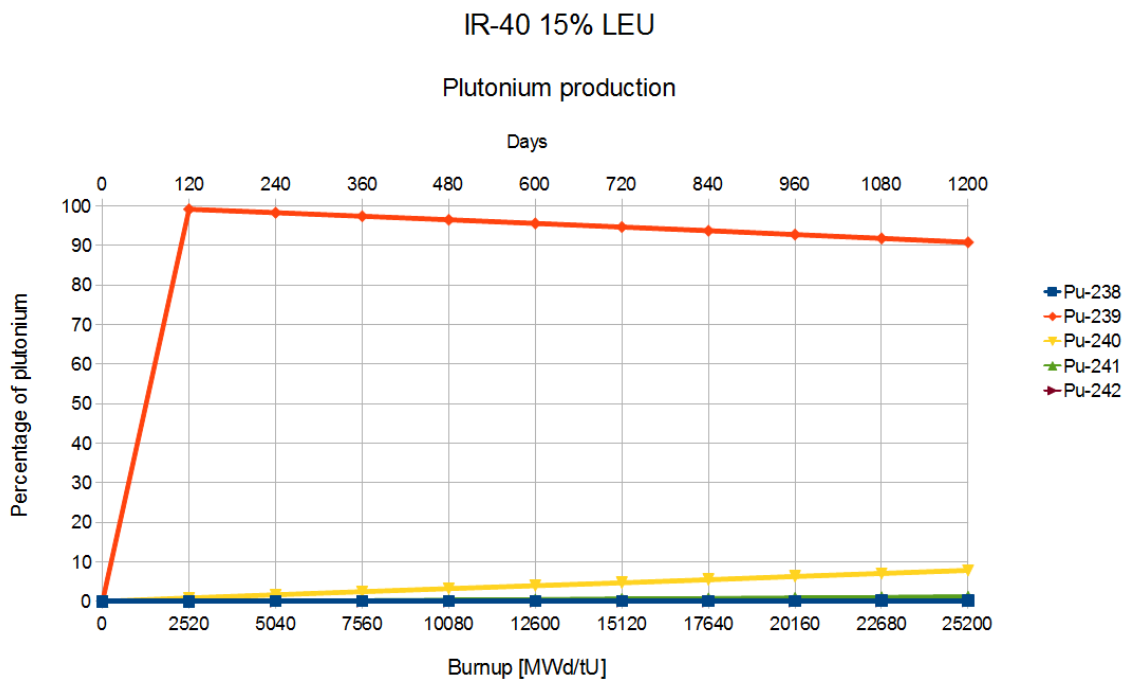

Figure 9-18. Plutonium production as a function of burnup and operation time at constant power.



#### 9.4.4 Radioisotope production

The modified core has 13 free positions indented for material research and radioisotope production, see Figure 9-11. TRITON estimates a thermal neutron flux of up to  $2 \cdot 10^{14}$  neutrons/cm<sup>2</sup> · s in the central core position, while the six vacant positions two rows further out, seen in Figure 9-11, receive a thermal neutron flux of up to  $6 - 7 \cdot 10^{13}$  neutrons/cm<sup>2</sup> · s and the position furthest out has a thermal neutron flux of  $4 - 5 \cdot 10^{13}$  neutrons/cm<sup>2</sup> · s.

The neutron flux is on the same order as the original core, meaning that the activity in an irradiated target will be about the same for the NU core as shown in Figure 9-8 and Figure 9-9. A modified core will be able produce more than enough <sup>99</sup>Mo to satisfy Iran's current and future demands.

#### 9.4.5 Fuel consumption

The fuel requirements for the LEU core are more complicated since it now requires 5 to 15 % enriched uranium. It is possible to estimate the average fuel consumption of the reactor to see if this matches what Iran is capable of producing in its enrichment program. The output from TRITON gives the amount of <sup>235</sup>U in the fuel at startup and after each irradiation period.

Uranium enrichment is measured in *Separative Work Units* (SWU), and is a measure of the separation work required to enrich uranium. The fuel consumption and the corresponding SWU need have also been calculated and are presented in Table 9-5. It is assumed that the fuel is enriched from natural uranium to the desired level of enrichment. The tails is taken to be 0.3 % of <sup>235</sup>U. It is assumed that the reactor, after initial testing will operate with a yearly capacity factor of 50-100 %. See Appendix B for SWU calculations.

Annual demand	5 % enriched		10 % enriched		15 % enriched	
	LEU [kg]	SWU	LEU [kg]	SWU	LEU [kg]	SWU
Capacity factor						
100 %	573	4122	573	9899	573	15875
90 %	515	3738	516	8904	515	14279
80 %	458	3294	458	7909	458	12683
70 %	401	2879	401	6914	401	11088
60 %	344	2519	344	5918	344	9492
50 %	286	2072	287	4950	286	7635

Table 9-5. The annual demand of LEU and the SWU needed for that amount as a function of fuel enrichment and capacity factor.

The annual SWU capacity at Iran's enrichment facility in Natanz is between 3500-4500 SWU [111]. In order to supply a core using 10 and 15 % enriched uranium it would thus need to expand the current enrichment capacity.

#### 9.4.6 Advantages

The calculations show that the plutonium production is significantly reduced compared to the NU reactor. If 5 % LEU is chosen and the fuel is irradiated for 1200 days, the plutonium produced will have a much poorer quality than in the NU fueled reactor.

The large excess reactivity in the LEU reactor compared to the NU reactor enables the reactor to use light water as coolant. This makes it possible to conduct experiments where LWR conditions can be simulated. The excess reactivity also enables 13 free channels in the centre of the core for experimental rigs and radioisotope production for medical use.

## 10 Discussion

The purpose of this thesis was to explore the feasibility and benefits of converting the IR-40 reactor to a more proliferation-resistant reactor. A probable design of the IR-40 reactor has been presented and simulated in SCALE 6.1.

Given the available information on the IR-40 reactor, it is believed that IR-40 will be a pressurized heavy water reactor employing 150 RBMK fuel assemblies placed in individual pressure tubes. Given Iran's limited uranium resources, the building of a pressurized heavy water research reactor is a logical step if they want to pursue CANDU-type reactors in the future to make the most of out their uranium.

Assuming the dimensions found for the IR-40 reactor are similar to the actual ones, it confirms the IR-40's potential proliferation risk. Enough fuel would be irradiated annually to provide fissile material for up to two plutonium-based NWs. It should be emphasized that Iran has not yet built, or is planning to build a reprocessing facility for extracting plutonium from irradiated fuel. But the hot cell facility being built at the IR-40 compound for radioisotope production, could be used to separate plutonium, though it would not be able to process large quantities annually, and it will be unable to do so undetected under the current IAEA inspections regime.. Even though the current regime is not taking active steps to build a reprocessing plant, once plutonium has been produced, its half-life of 24000 years (plutonium-239) means that it will only slowly decay, and future regimes may think differently about this potential nuclear weapon material.

The large production of WGPu is one of the main reasons for converting the IR-40 reactor to employ LEU fuel. The use of LEU results in a smaller core, and a 73 – 85 % reduction of annual plutonium production, depending on the level of enrichment of the LEU. The level of enrichment that gives the worst composition of plutonium, in the eyes of a weapons maker, is 5% LEU, while 15 % LEU produces the least amount of plutonium per irradiation time, but with a much better quality than 5 % enriched fuel.

Given Iran's current enrichment capacity (less than 6000 SWU per year), it is not possible for Iran to provide enough fuel to support 10 or 15 % LEU fuel in the reactor. The use of RBMK fuel rods limits the relative burn-up of uranium, because it can only operate for 1200 days due to material constraints. This results in a lot of unburned uranium in the spent fuel rods for enrichments of 10 and 15 %.

Combined, these factors lead to a conclusion that the use of 5 % enriched LEU for the modified reactor is the most proliferation-resistant enrichment level, has a high relative burnup and needs less annual enrichment capacity to sustain. It would still be possible to extract WGPu by irradiating the fuel for a short time, but such behavior would be detected by the IAEA.

The proposed modification of the reactor leads to more free positions inside core, which could be used for everything from experiments to radioisotope production. The increased excess reactivity allows for the use of light water instead of D<sub>2</sub>O as coolant.

Another positive aspect seen from a proliferation perspective is that a conversion will consume large parts of the LEU that Iran has produced and will produce in the future. Currently, Iran is producing LEU intended for near-future fuel production for the TRR, and it is producing more than the TRR consumes [112]. Even though, one of the arguments for building the IR-40 reactor in the first place was to shut down the over 40 year old TRR. The fuel already enriched for TRR could be blended down from 19.75 % to 5 %.

Most of Iran's current enrichment efforts, however, are directed at producing and stockpiling less than 5 % enriched uranium hexafluoride without turning it into fuel. Concerns prevail that Iran may someday reinsert enriched uranium hexafluoride to produce weapons-grade uranium. Further processing and consumption of enriched uranium would therefore alleviate some of these proliferation concerns.

Iran has invested much money and prestige in its enrichment program and is very reluctant to abandon it [113]. By reducing the stockpiled LEU by turning it into fuel for the converted IR-40 reactor, negotiations with Iran can move a step forward. Focus could then switch from Iran having an enrichment program and accepting it to openness and implementation of more secure safeguards agreements.

Iran has an undeniable right to pursue peaceful nuclear power, but in its quest for nuclear technology it should consider choosing technology that does not produce significant amounts of fissile material well suited for nuclear weapons.

This thesis shows a probable design for the IR-40 reactor. It also shows that it is possible to convert the current reactor to employ LEU fuel and attain the same good properties for radioisotope production, while being less suited for plutonium production. The LEU needed for the reactor could serve as a natural cap on Iran's uranium enrichment capacity until Iran and the IAEA have worked out their differences.

## References

- [1] Olli Heinonen, "Can the Nuclear Talks With Iran Be Saved?," 24.06.2011, [http://www.foreignpolicy.com/articles/2011/01/27/can\\_the\\_nuclear\\_talks\\_with\\_iran\\_be\\_saved](http://www.foreignpolicy.com/articles/2011/01/27/can_the_nuclear_talks_with_iran_be_saved).
- [2] David Albright and Paul Brannan, "Pakistan Doubling Rate of Making Nuclear Weapons: Time for Pakistan to Reverse Course ," 2011, <http://isis-online.org/isis-reports/detail/pakistan-doubling-rate-of-making-nuclear-weapons-time-for-pakistan-to-rever/> .
- [3] Central Intelligence Agency, "Iran," 2011, <https://www.cia.gov/library/publications/the-world-factbook/geos/ir.html>.
- [4] WILLIAM YONG: "Politically Confident, Iran Cuts Subsidies on Prices", *The New York Times*, 2011.
- [5] Halvor Kippe, "Irans kjernefysiske program - for kraftproduksjon eller kjernevåpen?," 2011.
- [6] Dieter Bednarz, Erich Follath and Holger Stark, "Intelligence from Tehran Elevates Concern in the West," 2011, <http://www.spiegel.de/international/world/0,1518,673802,00.html>.
- [7] Central Intelligence Agency, "Middle East," 2011, [https://www.cia.gov/library/publications/the-world-factbook/graphics/ref\\_maps/pdf/middle\\_east.pdf](https://www.cia.gov/library/publications/the-world-factbook/graphics/ref_maps/pdf/middle_east.pdf).
- [8] Director General, "Implementation of the NPT Safeguards Agreement in the Islamic Republic of Iran," pp. 1-28, GOV/2004/83 , 2004.
- [9] IAEA, "Research Reactor Database," 22.07.2011, <http://nucleus.iaea.org/RRDB/RR/HeaderInfo.aspx?RIId=311>.
- [10] Ray Takeyh, "Iran's nuclear calculations," 2003, [http://findarticles.com/p/articles/mi\\_hb6669/is\\_2\\_20/ai\\_n29026145/pg\\_4/](http://findarticles.com/p/articles/mi_hb6669/is_2_20/ai_n29026145/pg_4/).
- [11] World Nuclear Association, "Nuclear Energy in Iran," 26.07.2011, [http://www.world-nuclear.org/info/inf119\\_nucleariran.html](http://www.world-nuclear.org/info/inf119_nucleariran.html).
- [12] Fars News Agency, "Bushehr N. Power Plant to Go Fully Operational in February ," 2011, <http://english.farsnews.com/newstext.php?nn=9007274819>.
- [13] ISNA, "Bushehr Nuclear Power Plant Joins Iran's National Grid With 50% Capacity ," 2011, <http://www.payvand.com/news/11/oct/1115.html>.
- [14] David Fischer, *HISTORY OF THE INTERNATIONAL ATOMIC ENERGY AGENCY The First Forty Years*, 1997.

- [15] IAEA, "THE TEXT OF THE AGREEMENT BETWEEN IRAN AND THE AGENCY FOR THE APPLICATION OF SAFEGUARDS IN CONNECTION WITH THE TREATY ON THE NON-PROLIFERATION OF NUCLEAR WEAPONS," 1974, <http://www.iaea.org/Publications/Documents/Infcircs/Others/infcirc214.pdf>.
- [16] Director General, "Implementation of the NPT Safeguards Agreement in the Islamic Republic of Iran," pp. 1-8, GOV/2003/75, 2003.
- [17] David Albright and Paul Brannan, "Arak Heavy Water Reactor Construction Progressing," 2008, [http://isis-online.org/uploads/isis-reports/documents/Arak\\_13November2008.pdf](http://isis-online.org/uploads/isis-reports/documents/Arak_13November2008.pdf).
- [18] Director General, "Implementation of the NPT Safeguards Agreement and relevant provisions of Security Council resolutions in the Islamic Republic of Iran," pp. 1-25, GOV/2011/65, 2011.
- [19] Maseh Zarif, "U.S. Policy Toward Iran's Nuclear Program," 2009, <http://www.irantracker.org/us-policy/us-policy-toward-irans-nuclear-program>.
- [20] CHAIR OF THE VIENNA CHAPTER OF THE NON ALIGNED MOVEMENT, "VISIT OF THE CHAIRMAN OF THE VIENNA CHAPTER OF THE NON-ALIGNED MOVEMENT TO THE ISLAMIC REPUBLIC OF IRAN," 21.01.2011, <http://www.pmiran.at/NAM/NV%20NAM%20128%202011.pdf>.
- [21] Atomic Energy Organization of Iran, "Nuclear Industry in IRAN An overview on Iran's activities and achievements in nuclear technology," 2011.
- [22] Director General, "Implementation of the NPT Safeguards Agreement and relevant provisions of Security Council resolutions in the Islamic Republic of Iran," pp. 1-9, GOV/2011/54, 2011.
- [23] Director General, "Implementation of the NPT Safeguards Agreement and relevant provisions of Security Council resolutions 1737 (2006), 1747 (2007), 1803 (2008), and 1835 (2008) in the Islamic Republic of Iran," pp. 1-6, GOV/2009/55, 2009.
- [24] Director General, "Implementation of the NPT Safeguards Agreement and relevant provisions of Security Council resolutions in the Islamic Republic of Iran," pp. 1-11, GOV/2010/46, 2010.
- [25] Director General, "Implementation of the NPT Safeguards Agreement and relevant provisions of Security Council resolutions in the Islamic Republic of Iran," pp. 1-9, GOV/2011/29, 2011.
- [26] David Albright, Frans Berkhout and William Walker, *Plutonium and Highly Enriched Uranium 1996 World Inventories, Capabilities and Policies*, 1997.
- [27] Samuel Glasstone and Alexander Sesonske, *Nuclear reactor engineering reactor design basics vol 1 and 2*, Fourth ed., Springer, 1994, 0-412-98521-7 0-412-98531-4.
- [28] John Lilley, *Nuclear Physics Principles and Applications*, pp. 1-393, 2001, 0-471-97936-8 .

- [29] John R.Lamarsh and Anthony J.Baratta, *Introduction to Nuclear Engineering*, 2001, 0-201-82498-1.
- [30] John T.Moore, "Nuclear Fission Basics," 2011, <http://www.dummies.com/how-to/content/nuclear-fission-basics.html>.
- [31] IAEA, "Joint Evaluated Fission and Fusion File, Incident-neutron data Chain Fission Yields ," 2006, <http://www-nds.iaea.org/sgnucdat/c1.htm#92-U-235>.
- [32] Elmer Lewis, *Fundamentals of Nuclear Reactor Physics*, 1 ed. 2008, 0123706319 .
- [33] J.Kenneth Shultis and Richard E.Faw, *Fundamentas of Nuclear Science and Engineering*, 2 ed. 2008, 1420051350.
- [34] MIT, "Reactor Physics - Part Thirteen. Criticality Conditions," 2011, <http://www.core.org.cn/NR/rdonlyres/Nuclear-Engineering/22-05Fall-2006/AF9A3F36-803B-4393-B345-7F22E923A845/0/lecture13.pdf>.
- [35] Panther, "wwer-1000-scheme," 2005, <http://en.wikipedia.org/wiki/File:Wwer-1000-scheme.png>.
- [36] Alexander Glaser, "About the Enrichment Limit for Research Reactor Conversion: Why 20%?," 2005.
- [37] David Bodansky, "Nuclear Energy Pirinciples, Practices and Prospects," 1996.
- [38] B.Rouben, "Introduction to Reactor Physics," 2002, <http://canteach.candu.org/library/20040501.pdf>.
- [39] Alexander Glaser, Zia Mian and Frank N.von Hippel, "Time to Ban Production of Nuclear Weapons Material," 2011, <http://www.scientificamerican.com/article.cfm?id=time-to-ban-production-of-nuclear-weapons-material&page=2>.
- [40] Wikipedia, "Gun-type fission weapon en-labels thin lines," 2011, [http://en.wikipedia.org/wiki/File:Implosion\\_Nuclear\\_weapon.svg](http://en.wikipedia.org/wiki/File:Implosion_Nuclear_weapon.svg).
- [41] Heidi Kristine Toft: "Kjernevåpens fysikk og virkemåte", *Fra fysikkens verden*, 2009.
- [42] John Coster-Mullen, *Atom bombs - the top secret inside story of Little Boy and Fat Man*, 2007.
- [43] Wikipedia, "Implosion Nuclear weapon," 2011, [http://en.wikipedia.org/wiki/File:Implosion\\_Nuclear\\_weapon.svg](http://en.wikipedia.org/wiki/File:Implosion_Nuclear_weapon.svg).
- [44] Fars News Agency, "Ahmadinejad Reiterates Peaceful Nature of Iran's N. Program," 2011, <http://english.farsnews.com/newstext.php?nn=9007274705>.
- [45] J.Carson Mark, "Explosive Properties of Reactor-Grade Plutonium," *Science and Global Security*, vol. 4, pp. 111-128, 1993.

- [46] HarDNox, "PuIsotopes," 2011, <http://upload.wikimedia.org/wikipedia/commons/9/96/PuIsotopes.png>.
- [47] N.Ensslin, "The Origin of Neutron Radiation," 2011, <http://www.fas.org/sgp/othergov/doe/lanl/lib-www/la-pubs/00326406.pdf>.
- [48] David Bodansky, *Nuclear Energy - Principles, practices, and prospects*, Second ed. 2004, 978-0-387-20778-0.
- [49] J.Carson Mark, "Reactor-Grade Plutoniums Explosive Properties," 08.1990, <http://www.nci.org/NEW/NT/rgpu-mark-90.pdf>.
- [50] The united states department of energy, "Nonproliferation and Arms Control Assessment of Weapons-Usable Fissile Material Storage and Excess Plutonium Disposition AIternatives," 1997, [http://www.fissilematerials.org/ipfm/site\\_down/doe97.pdf](http://www.fissilematerials.org/ipfm/site_down/doe97.pdf).
- [51] Sigfried S.Hecker, "Plutonium and Its Alloys From atoms to microstructure," *Los Alamos Science*, 26, pp. 290-335, 2000.
- [52] MARVIN M.MILLER, "HEAVY WATER AND NONPROLIFERATION," 1980, <http://dspace.mit.edu/handle/1721.1/35174>.
- [53] House of commons Foreign Affairs Committe, "Global security: Iran Fifth Report of Session 2007 - 08," 2008.
- [54] The Australian Nuclear Science and Technology Organisation, "radioisotopes their role in society today," 2011, [http://www.ansto.gov.au/\\_data/assets/pdf\\_file/0018/3564/Radioisotopes.pdf](http://www.ansto.gov.au/_data/assets/pdf_file/0018/3564/Radioisotopes.pdf).
- [55] National Research Council, "Alternative Molybdenum-99 Production Processes," 2009, [http://books.nap.edu/catalog.php?record\\_id=12569](http://books.nap.edu/catalog.php?record_id=12569).
- [56] Dr Ron Cameron, "Using LEU in OPAL ANSTO's State of the Art Multipurposen Research Reactor," 2006, [http://www.7ni.mfa.no/NR/rdonlyres/EC9F5DE51CE947AF88C060C5E1865D8A/60590/Cameron\\_Presentation\\_Using\\_LEU\\_in\\_OPAL.pdf](http://www.7ni.mfa.no/NR/rdonlyres/EC9F5DE51CE947AF88C060C5E1865D8A/60590/Cameron_Presentation_Using_LEU_in_OPAL.pdf).
- [57] IAEA, "Manual for reactor produced radioisotopes," 2003, [http://www-pub.iaea.org/MTCD/Publications/PDF/te\\_1340\\_web.pdf](http://www-pub.iaea.org/MTCD/Publications/PDF/te_1340_web.pdf).
- [58] R.Sayareh, M.Ghannadi Maragheh, and M.Shamsaie, "Theoretical calculations for the production of <sup>99</sup>Mo using natural uranium in Iran," *Annals of Nuclear Energy*, vol. 30, 8, pp. 883-895, 2003.
- [59] Rob Adam, "COMMERCIAL SCALE PRODUCTION OF LEU BASED MOLYBDENUM 99 IN SOUTH AFRICA," 2010.
- [60] Fars News Agency, "Exhibition of Iran's N. Achievements Kicks Off in Tehran ," 2011, <http://english.farsnews.com/newstext.php?nn=9007274609>.



- [61] Institute for Science and International Security, "Nuclear Sites," 27.07.2011, <http://www.isisnucleariran.org/sites/detail/tehran/>.
- [62] IAEA, "TRR," 28.08.2011, <http://nucleus.iaea.org/RRDB/RR/TechnicalData.aspx?RId=214>.
- [63] IAEA Research Reactor Database, "TRR," 2009, <http://nucleus.iaea.org/RRDB/RR/TechnicalData.aspx?RId=214>.
- [64] David Albright, "Technical Note: Annual Future Low-Enriched Uranium Fuel Requirements for the Tehran Research Reactor ," 2009, [http://www.isisnucleariran.org/assets/pdf/Tehran\\_reactor\\_note\\_7Oct2009.pdf](http://www.isisnucleariran.org/assets/pdf/Tehran_reactor_note_7Oct2009.pdf).
- [65] Christina Walrond, "TIMELINE 1967-1993: ARGENTINE LOW-ENRICHED URANIUM AT TEHRAN RESEARCH REACTOR ," 2009, [http://www.isisnucleariran.org/assets/pdf/Tehran\\_reactor\\_timeline.pdf](http://www.isisnucleariran.org/assets/pdf/Tehran_reactor_timeline.pdf).
- [66] IAEA, "Radioisotope handling facilities and automation of radioisotope production," 2004.
- [67] Nuclear Energy Agency, "The Supply of Medical Radioisotopes Review of Potential Molybdenum-99/Technetium-99m Production Technologies," 2010, <http://www.oecd-nea.org/med-radio/reports/Med-Radio-99Mo-Prod-Tech.pdf>.
- [68] European Nuclear Society, "Transactions," 2011.
- [69] George Braoudakis, "Question about radioisotope production," 2011.
- [70] Google earth, "Heavy water complex. 34 22' 25" N, 49 14' 26" E," 2011.
- [71] The Institute for Science and International Security, "Arak IR-40 Heavy Water Reactor," 2010, <http://www.isisnucleariran.org/sites/facilities/arak-ir-40/>.
- [72] The Institute for Science and International Security, "Update on the Arak Reactor in Iran ," 25.09.2009, [http://isis-online.org/uploads/isis-reports/documents/Arak\\_Update\\_25\\_August2009.pdf](http://isis-online.org/uploads/isis-reports/documents/Arak_Update_25_August2009.pdf).
- [73] David Albright, Paul Brannan and Robert Kelley, "Mysteries Deepen Over Status of Arak Reactor Project ," 2011, <http://www.isisnucleariran.org/assets/pdf/ArakFuelElement.pdf>.
- [74] Wikipedia, "Rbmk fuel rods holder," 07.10.2011, [http://upload.wikimedia.org/wikipedia/commons/a/a3/Rbmk\\_fuel\\_rods\\_holder.png](http://upload.wikimedia.org/wikipedia/commons/a/a3/Rbmk_fuel_rods_holder.png).
- [75] ELEMASH, "RBMK-1000 and RBMK-1500 nuclear fuel," 2011, <http://www.elemash.ru/en/production/Products/NFCP/RBMK/>.
- [76] IAEA, "Heavy water reactors: status and projected development," 2002, <http://canteach.candu.org/iaea.html>.

- [77] Ausra Marao, Tadas Kaliatka and Eugenijus Uspuras, "Analysis of processes in RBMK-1500 fuel assemblies during normal operation cycle," 2010, <http://www.lmaleidykla.lt/publ/0235-7208/2010/1/8-18.pdf>.
- [78] European fuel group, "Fuel design data," *Nuclear Engineering International*, September 2008, pp. 26-36, 2011.
- [79] Wolfgang Wiesenack, "IR - 40," 19.07.2011.
- [80] Bhabha Atomic Research Centre, "Dhruva reactor," 22.07.2011, <http://www.barc.ernet.in/reactors/dhruva.html>.
- [81] S.K.Agarwal, C.G.Karhadkar, A.K.Zope, and Kanchhi Singh, "Dhruva: Main design features, operational experience and utilization," *Nuclear Engineering and Design*, vol. Volume 236, 7-8, pp. 747-757, 2005.
- [82] AECL, "National Research Universal Profile," 25.07.2011, <http://www.aecl.ca/Science/CRL/NRU.htm>.
- [83] D.F.Sears and K.T.Conlon, "DEVELOPMENT OF LEU FUEL FOR RESEARCH REACTORS: NRU, MAPLE AND SLOWPOKE," 17.06.2006, [http://www.7ni.mfa.no/NR/rdonlyres/EC9F5DE51CE947AF88C060C5E1865D8A/60613/Sears\\_Paper\\_Development\\_of\\_LEU\\_Fuel\\_for\\_Research\\_R.pdf](http://www.7ni.mfa.no/NR/rdonlyres/EC9F5DE51CE947AF88C060C5E1865D8A/60613/Sears_Paper_Development_of_LEU_Fuel_for_Research_R.pdf).
- [84] NTI, "China's Research Reactors , " 2003, <http://www.nti.org/db/china/resrctr.htm>.
- [85] IAEA, "Research Reactor Details - HWRR-II," 1994, [http://www-naweb.iaea.org/naweb/physics/research\\_reactors/database/rr%20data%20base/datasets/report/China,%20People's%20Republic%20of%20%20Research%20Reactor%20Details%20-%20HWRR-II.htm](http://www-naweb.iaea.org/naweb/physics/research_reactors/database/rr%20data%20base/datasets/report/China,%20People's%20Republic%20of%20%20Research%20Reactor%20Details%20-%20HWRR-II.htm).
- [86] International Business Publications, "Global Research nuclear Reactors Handbook," 2011, <http://books.google.com/books?id=r2dl2fvpD18C&printsec=frontcover#v=onepage&q&f=false>.
- [87] IAEA, "Research Reactor Details - ES-SALAM," 2009, [http://www-naweb.iaea.org/naweb/physics/research\\_reactors/database/RR%20Data%20Base/datasets/report/Algeria,%20People's%20Democratic%20Republic%20of%20%20Research%20Reactor%20Details%20-%20ES-SALAM.htm](http://www-naweb.iaea.org/naweb/physics/research_reactors/database/RR%20Data%20Base/datasets/report/Algeria,%20People's%20Democratic%20Republic%20of%20%20Research%20Reactor%20Details%20-%20ES-SALAM.htm).
- [88] Rezoug Khelifa, "ES SALAM RESEARCH REACTOR," 25.07.2011, <http://www-ns.iaea.org/downloads/rw/projects/r2d2/workshop3/national-presentations/algeria-es-salam-research-reactor.pdf>.
- [89] Bruno Tertrais, "AFTER IRAN: PROSPECTS FOR NUCLEAR PROLIFERATION IN NORTH AFRICA," 30.08.2010, [http://www.npolicy.org/article\\_file/After\\_Iran\\_Prospects\\_for\\_Nuclear\\_Proliferation\\_in\\_North\\_Africa.pdf](http://www.npolicy.org/article_file/After_Iran_Prospects_for_Nuclear_Proliferation_in_North_Africa.pdf).

- [90] AECL, "National Research Universal Profile," 2011, <http://www.aecl.ca/Programs/NRU.htm>.
- [91] P.C.ERNST, "RESEARCH REACTOR SPENT FUEL STATUS," 1997, [http://www-pub.iaea.org/MTCD/publications/PDF/csp\\_004c/PDFfiles/003.pdf](http://www-pub.iaea.org/MTCD/publications/PDF/csp_004c/PDFfiles/003.pdf).
- [92] National Research Council Canada, "NRU Reactor," 2011, <http://www.nrc-cnrc.gc.ca/eng/ibp/cnbc/about/nru-reactor.html>.
- [93] C.V.Parks, C.M.Hopper and J.J.Lichtenwalter, "Assessment and Recommendations for Fissile-Material Packaging Exemptions and General Licenses Within 10 CFR Part 71," pp. 1-118, NUREG/CR-5342 ORNL/TM-13607, 1998.
- [94] Thomas B.Cochran, "What is the Size of Khushab II?," 2006, [http://docs.nrcd.org/nuclear/files/nuc\\_06090801A.pdf](http://docs.nrcd.org/nuclear/files/nuc_06090801A.pdf).
- [95] Farshad Faghihi, E.Ramezani, F.Yousefpour and S.M.Mirvakili, "Level-1 probability safety assessment of the Iranian heavy water reactor using SAPHIRE software," 18.10.2007, <http://www.sciencedirect.com/science/article/pii/S0951832007002463>.
- [96] Saman Tashakor, Farshid Javidkia and Mehdi Hashemi-Tilehnoee, "Neutronic Analysis of Generic Heavy Water Research Reactor Core Parameters to Use Standard Hydride Fuel," 2011, <http://www.scirp.org/Journal/PaperInformation.aspx?paperID=6363>.
- [97] Mehdi Hashemi-Tilehnoee and S. T. A.Pazirandeh, "HAZOP-study on heavy water research reactor primary cooling system," 2010, <http://www.sciencedirect.com/science/article/pii/S0306454909003806>.
- [98] A.Moosakhani, M.N.Nasrabadi and B.Timuri, "Monte Carlo calculation of the core of the heavy water zero power reactor (HWZPR) using MCNP4c," 2011, <http://www.sciencedirect.com/science/article/pii/S0029549311001105>.
- [99] World Journal of Nuclear Science and Technology, "World Journal of Nuclear Science and Technology," 1 ed 2011, <http://www.scirp.org/Journal/PaperDownload.aspx?issueID=916&issueType=content>.
- [100] B.T.Rearden, L.M.Petrie, D.E.Peplow, M.A.Jessee, D.Wiarda, M.L.Williams, R.A.Lefebvre, J.P.Lefebvre, I.C.Gauld and S.Goluoglu, "SCALE 6.1 ENHANCEMENTS FOR NUCLEAR CRITICALITY SAFETY," 2011, <http://info.ornl.gov/sites/publications/files/Pub31463.pdf>.
- [101] S.M.Bowman, "KENO-VI Primer: A Primer for Criticality Calculations with SCALE/KENO-VI Using GeeWiz," 2008.
- [102] Weston M.Stacey, *Nuclear Reactor Physics*, 2 ed. 2007, 3527406794.

- [103] MIT, "Reactor Physics - Part Twenty-Four. Monte Carlo Analysis ," 2011, <http://www.core.org.cn/NR/rdonlyres/Nuclear-Engineering/22-05Fall-2006/D227BCAA-F65F-4A29-ACE5-ED8F4A251048/0/lecture24.pdf>.
- [104] Oak Ridge National Laboratory, "Scale: A Comprehensive Modeling and Simulation Suite for Nuclear Safety Analysis and Design," ORNL/TM-2005/39 ed 2011.
- [105] W.J.Marshall and B.T.Rearden, "Criticality Safety Validation of Scale 6.1," ORNL/TM-2011/450, 2011.
- [106] Brad Rearden, "SCALE," 2011.
- [107] D.F.Hollenbach, L.M.Petrie and N.F.Landers, "KENO-VI: A GENERAL QUADRATIC VERSION OF THE KENO PROGRAM," 1998, pp. 1-524.
- [108] Mark D.DeHart, "HIGH-FIDELITY LATTICE PHYSICS CAPABILITIES OF THE SCALE CODE SYSTEM USING TRITON," 2007, [http://www.ornl.gov/sci/scale/papers/Monterey\\_paper\\_SCALE.pdf](http://www.ornl.gov/sci/scale/papers/Monterey_paper_SCALE.pdf).
- [109] Mark D.DeHart, "High-Fidelity Depletion Capabilities of the SCALE Code System Using TRITON," 2011, [http://www.ornl.gov/sci/scale/pubs/04\\_TRITON\\_HiFidelity\\_Depletion.pdf](http://www.ornl.gov/sci/scale/pubs/04_TRITON_HiFidelity_Depletion.pdf).
- [110] H- Gruemm, "Safeguards and Tamuz: setting the record straight," *IAEA Bulletin*, vol. 23, 4, 1981.
- [111] David Albright, Paul Brannan, Andrea Stricker and Christina Walrond, 2011, [http://isis-online.org/uploads/isis-reports/documents/IAEA\\_Iran\\_Report\\_ISIS\\_analysis\\_08Nov2011.pdf](http://isis-online.org/uploads/isis-reports/documents/IAEA_Iran_Report_ISIS_analysis_08Nov2011.pdf).
- [112] David Albright and Christina Walrond, "Determining the purpose of Iran's growing stock of 19.75 percent enriched uranium: Production should be capped," 2011, [http://isis-online.org/uploads/isis-reports/documents/Determining\\_the\\_purpose\\_of\\_Irans\\_growing\\_stock\\_of\\_1975\\_21Sept2011.pdf](http://isis-online.org/uploads/isis-reports/documents/Determining_the_purpose_of_Irans_growing_stock_of_1975_21Sept2011.pdf).
- [113] Institute for Science and International Security, "Abbasi-Davani Interview on Iran's 20 Percent Enrichment ," 31.08.2011, <http://isis-online.org/isis-reports/detail/abbasi-davani-interview-on-irans-20-percent-enrichment/8>.
- [114] WISE Uranium Project, "Uranium Enrichment Calculator," 2009, <http://www.wise-uranium.org/nfcue.html>.

## Symbols and Units

Symbol	Unit	Description
E	[J]	Energy
P	[J/s]	Power
m	[kg]	Mass
n	[-]	Neutron
$n$	[m <sup>-3</sup> ]	Neutron density
$\alpha$	[-]	Alfa particle
$\beta^+$	[-]	Beta particle (positron)
$\beta^-$	[-]	Beta particle (electron)
$\gamma$	[-]	Gamma ray
p	[-]	Proton
$\sigma$	[m <sup>-2</sup> ]	Microscopic cross section
$\Sigma$	[m <sup>-1</sup> ]	Macroscopic cross section
Bq	[s <sup>-1</sup> ]	Disintegrations per second (activity)
Ci	[s <sup>-1</sup> ]	37 billion disintegrations per second (activity)
eV	[J]	Electronvolt
MeV	[J]	Megaelectronvolt
GWd	[J]	Gigawatt days
GW <sub>e</sub>	[J]	Gigawatt electric
MW <sub>e</sub>	[W]	Megawatt electric
MW <sub>th</sub>	[W]	Megawatt thermal
k <sub>eff</sub>	[-]	Effective multiplication factor

## Abbreviations

AEOI	Atomic Energy Organization of Iran
CANDU	CANada Deuterium Uranium
CSA	Comprehensive Safeguards Agreement
D <sub>2</sub> O	Deuterium oxide / heavy water
GeeWiz	Graphically Enhanced Editing Wizard
HEU	Highly enriched uranium
HWPP	Heavy water production plant
HWR	Heavy water reactor
IAEA	International Atomic Energy Agency
IHWRR	Iranian Heavy Water Research Reactor

IR-40	Iranian Nuclear Research Reactor
LEU	Low enriched uranium
LWR	Light water reactor
NATO	North Atlantic Treaty Organization
NPT	Non-Proliferation Treaty
NU	Natural uranium
NW	Nuclear weapon
PHWR	Pressurized heavy water reactor
PWR	Pressurized water reactor
SCALE	Standardized Computer Analysis for Licensing Evaluation
SWU	Separative work units
TRITON	Transport Rigor Implemented with Time-dependent Operation for Neutronic depletion
TRR	Tehran Research Reactor
UNSC	United Nations Security Council
UO <sub>2</sub>	Uranium dioxide
WGPu	Weapons-grade plutonium
WGU	Weapons-grade uranium

## Appendix A

The minimum size of IR-40 core fueled with NU is estimated using diffusion theory (see Chapter 3). Equation 18 and 19 are used for the calculation of the smallest critical radius of the core. The equations consist of  $k_{\infty}$ ,  $B_m^2$ ,  $M^2$ ,  $L$ ,  $L_s^2$ . These factors must be calculated before the size is estimated.  $k_{\infty}$ ,  $M^2$  and  $L$  vary as a function of moderator-to-fuel ratio. The following equations show how the factors are calculated.

The four factor formula

$$k_{\infty} = \eta \epsilon p f$$

The different factors in  $k_{\infty}$ ,  $\eta$ ,  $\epsilon$ ,  $p$  and  $f$  are calculated using the following equations [28].

$\eta$  is given by

$$\eta = \nu \times \left[ \frac{x \times \sigma_f(235)}{x \times \sigma_a(235) + \sigma_c(1-x)(238)} \right]$$

where  $x$  is the fraction (in %) of  $^{235}_{92}\text{U}$  in the fuel.  $\nu$  is number of neutrons released in a fission reaction (for  $^{235}_{92}\text{U}$  this is 2.42),  $\sigma_f$  is the fission cross section of  $^{235}_{92}\text{U}$ ,  $\sigma_a$  is the absorption cross section of  $^{235}_{92}\text{U}$  and  $\sigma_c$  is the capture cross section of  $^{238}_{92}\text{U}$ .

For a dilute reactor, the fast fission factor  $\epsilon$  only gives a small contribution to the chain reaction and is keep at unity [28].

The resonance escape probability  $p$  is given by

$$p = \exp \left[ - \frac{2.73}{\langle \xi \rangle} \left\{ \frac{N_{238}}{\Sigma_s} \right\}^{0.514} \right]$$

where  $N_{238}$  is the number of  $^{238}_{92}\text{U}$  atoms relative to moderator atoms,  $\Sigma_s$  is the total macroscopic scattering cross section and  $\langle \xi \rangle$  is the mean logarithmic energy decrement for the moderator-fuel mixture. In a dilute reactor  $\langle \xi \rangle$  is approximately the same as for a pure moderator.

$f$  is given by

$$f = \frac{\Sigma_a(F)}{\Sigma_a(C)} = \frac{\Sigma_a(F)}{\Sigma_a(F) + \Sigma_a(M) + \dots} = \frac{N_F \sigma_a(F)}{N_F \sigma_a(F) + N_M \sigma_a(M) + \dots}$$

Where  $C$ ,  $F$ ,  $M$  and ... refer to the core, fuel, moderator and other neutron absorbing materials in the core.

To find the radius and the height of the core by means of geometric buckling, the material buckling has to be calculated first.  $B_m^2$  is calculated by rearranging equation (19)

$$\frac{k_\infty - 1}{L_s^2 + L^2} = B_m^2$$

$L^2$  is a function of  $L_T^2$ .  $L_T^2$  is dependent on the temperature and density of the moderator [29].  $L_T^2$  for heavy water is found by

$$L_T^2 = (\rho, T) = L_T^2(\rho_0, T_0) \left(\frac{\rho_0}{\rho}\right)^2 \left(\frac{T}{T_0}\right)^{0,612}$$

where  $\rho_0$  is the pressure at 20 °C, and  $T_0$  is the temperature at 20 °C.

The diffusion data for D<sub>2</sub>O at temperature T<sub>0</sub> (20 °C) is found in [29]:

Density [g/cm <sup>3</sup> ]	$L_T^2$ [cm <sup>2</sup> ]	$L_s^2$ [cm <sup>2</sup> ]
1.1	9400	131

The IR-40 reactor is believed to employ heavy water at a temperature of 70 °C and a pressure of 0.28 MPa bar [95]. The change in density in heavy water because of the increased pressure will negligible, and does not have to be calculated. Modifying  $L_T^2$  for a moderator temperature of 70 °C, results in a new  $L_T^2$  of 10351 cm<sup>2</sup>.

Diffusion data for a CANDU reactor is found in [32]:

Density [g/cm <sup>3</sup> ]	$L_T^2$ [cm <sup>2</sup> ]	$L_s^2$ [cm <sup>2</sup> ]
1.1	243	134

The lower value for  $L_T^2$  for a CANDU-type reactor corresponds to the use of light water in the cooling circuit.

Different  $B_m^2$  can now be calculated by varying the fuel-moderator ratio. When  $B_m^2$  has been calculated, it is set equal to  $B_g^2$  and the radius  $R$  is calculated. For a height-to-radius ratio of 2.1, equation (14) is rearranged to yield  $R$

$$R = \sqrt{\frac{2.405^2 \cdot 2.1^2 + \pi^2}{2.1^2 \cdot B_m^2}}$$



The height is given by multiplying the radius by 2.1. The volume of the a cylindrical core is found using

$$V = R^2 \cdot \pi \cdot H$$

For a reflected cylindrical reactor the critical radius is reduced by

$$R_{reflected} = R - \delta$$

While the height is reduced by

$$H_{reflected} = H - 2 \cdot \delta$$

A bare HWR core using D<sub>2</sub>O diffusion data yields these configurations by varying the ratio of moderator to fuel.

$N_M / N_F$	f	$\rho$	$k_\infty$	$B^2$ [cm <sup>2</sup> ]	Radius [cm]	Volume [m <sup>3</sup> ]
60	0,992	0,823	1,084	0,000398	141,9	18,86
70	0,991	0,835	1,099	0,000441	134,9	16,20
80	0,990	0,846	1,111	0,000466	131,2	14,91
90	0,988	0,854	1,121	0,000479	129,4	14,28
100	0,987	0,861	1,129	0,000485	128,6	14,02
<b>110</b>	<b>0,986</b>	<b>0,867</b>	<b>1,136</b>	<b>0,000486</b>	<b>128,4</b>	<b>13,98</b>
120	0,984	0,873	1,141	0,000484	128,8	14,10
130	0,983	0,878	1,146	0,000478	129,5	14,32
140	0,982	0,882	1,150	0,000472	130,4	14,63
150	0,981	0,886	1,154	0,000464	131,5	15,01
160	0,979	0,889	1,157	0,000455	132,8	15,43
170	0,978	0,893	1,160	0,000446	134,1	15,91

A reflected HWR core using D<sub>2</sub>O diffusion data yields these configurations by varying the ratio of moderator to fuel.

$N_M / N_F$	f	p	$k_\infty$	$B^2$ [cm <sup>2</sup> ]	Radius [cm]	Radius with reflector [cm]	Height [cm]	Height with reflector [cm]	Volume [m <sup>3</sup> ]
40	0,995	0,786	1,039	0,000208	196,3	99,4	412,32	218,41	6,78
50	0,993	0,807	1,065	0,000327	156,6	59,6	328,83	134,92	1,51
60	0,992	0,823	1,084	0,000398	141,9	45	298,09	104,19	0,66
70	0,991	0,835	1,099	0,000441	134,9	38	283,31	89,4	0,4
80	0,99	0,846	1,111	0,000466	131,2	34,3	275,6	81,69	0,3
90	0,988	0,854	1,121	0,000479	129,4	32,4	271,66	77,76	0,26
100	0,987	0,861	1,129	0,000485	128,6	31,6	269,98	76,07	0,24
<b>110</b>	<b>0,986</b>	<b>0,867</b>	<b>1,136</b>	<b>0,000486</b>	<b>128,4</b>	<b>31,5</b>	<b>269,74</b>	<b>75,83</b>	<b>0,24</b>
120	0,984	0,873	1,141	0,000484	128,8	31,8	270,49	76,58	0,24
130	0,983	0,878	1,146	0,000478	129,5	32,5	271,92	78,02	0,26
140	0,982	0,882	1,15	0,000472	130,4	33,5	273,86	79,96	0,28
150	0,981	0,886	1,154	0,000464	131,5	34,6	276,18	82,27	0,31
160	0,979	0,889	1,157	0,000455	132,8	35,8	278,79	84,88	0,34
170	0,978	0,893	1,16	0,000446	134,1	37,1	281,61	87,71	0,38

A bare HWR core using CANDU diffusion data yields these configurations by varying the ratio of moderator to fuel.

$N_M / N_F$	f	p	$k_\infty$	$B^2$ [cm <sup>2</sup> ]	Radius [cm]	Volume [m <sup>3</sup> ]
210	0,973	0,903	1,167	0,001179	82,5	3,70
220	0,972	0,905	1,169	0,001186	82,2	3,67
230	0,971	0,907	1,170	0,001191	82,1	3,65
240	0,969	0,909	1,171	0,001195	81,9	3,63
250	0,968	0,911	1,171	0,001198	81,8	3,61
260	0,967	0,913	1,172	0,001200	81,8	3,61
270	0,966	0,914	1,173	0,001201	81,7	3,60
<b>280</b>	<b>0,964</b>	<b>0,916</b>	<b>1,173</b>	<b>0,001202</b>	<b>81,7</b>	<b>3,60</b>
290	0,963	0,917	1,174	0,001202	81,7	3,60
300	0,962	0,919	1,174	0,001201	81,7	3,60
310	0,961	0,920	1,174	0,001199	81,8	3,61
320	0,960	0,921	1,174	0,001197	81,9	3,62

A reflected HWR core using CANDU diffusion data yields these configurations by varying the ratio of moderator to fuel.

$N_M / N_F$	f	p	$k_\infty$	$B^2$ [cm <sup>2</sup> ]	Radius [cm]	Radius with reflector [cm]	Height with reflector [cm]	Volume [m <sup>3</sup> ]
220	0,972	0,905	1,169	0,001186	82,2	62,8	133,8	1,66
230	0,971	0,907	1,170	0,001191	82,1	62,6	133,5	1,64
240	0,969	0,909	1,171	0,001195	81,9	62,5	133,2	1,63
250	0,968	0,911	1,171	0,001198	81,8	62,4	133,0	1,63
260	0,967	0,913	1,172	0,001200	81,8	62,3	132,8	1,62
270	0,966	0,914	1,173	0,001201	81,7	62,3	132,7	1,62
280	0,964	0,916	1,173	0,001202	81,7	62,3	132,7	1,62
290	0,963	0,917	1,174	0,001202	81,7	62,3	132,7	1,62
300	0,962	0,919	1,174	0,001201	81,7	62,3	132,8	1,62
310	0,961	0,920	1,174	0,001199	81,8	62,3	132,9	1,62
320	0,960	0,921	1,174	0,001197	81,9	62,4	133,0	1,63
330	0,958	0,922	1,174	0,001195	81,9	62,5	133,2	1,63
340	0,957	0,924	1,174	0,001192	82,0	62,6	133,4	1,64
350	0,956	0,925	1,174	0,001189	82,2	62,7	133,6	1,65
360	0,955	0,926	1,174	0,001185	82,3	62,8	133,9	1,66

## Appendix B

### RBMK dimensions

The bottom area of a cylinder with a diameter of 325 cm is

$$A = \pi \left( \frac{D}{2} \right)^2 = \pi \left( \frac{3.25 \text{ m}}{2} \right)^2 = 8.3 \text{ m}^2$$

A square lattice pitch of 18 cm fans out an area of 0.032 m<sup>2</sup>, while a hexagonal lattice pitch fans out an area of 0.033 m<sup>2</sup>. The maximum number of assemblies is given by dividing the bottom area with the “lattice area”

$$\text{Number of assemblies} = \frac{8.3 \text{ m}^2}{0.032 \text{ m}^2} = 259$$

for a square lattice and

$$\text{Number of assemblies} = \frac{8.3 \text{ m}^2}{0.033 \text{ m}^2} = 247$$

for a hexagonal lattice.

### Cooling considerations for LEU fuel

The data on RBMK fuel limits the fuel to an average linear heat rate of 205 W/cm and a maximum power per channel of 1.5-2.0 MW. At the same time, the fuel should maintain a height-to-radius of about 1:2.1. Because of excess reactivity, each assembly now consists of 14 fuel rods.

The core uses 60 fuel assemblies, where each fuel rod employs standard RBMK dimensions except that the active fuel region is only 240 cm long.

Average linear heat rate (ALHR) is given as

$$ALHR = \frac{40 \text{ MW}}{60 \text{ fuel channels} \times 14 \text{ rods per assembly} \times 240 \text{ cm}} = 0,20 \text{ kW/cm}$$

The power per channel (PPC) is given as

$$PPC = \frac{40 \text{ MW}}{60 \text{ fuel channels}} = 0.67 \text{ MW / fuel channel}$$

### Corresponding enrichment requirements for the LEU core

The process of enriching uranium involves three streams of material, the input called *feed*, the output called *product*, and the residue called *tails*. The enrichment requirement is

measured by a quantity called *separative work units* (SWU) and has the dimensions of mass [37]. The amount of separative work needed to enrich a quantity of uranium is calculated by looking at the different mass streams of feed, product and tails.

Separation work is calculated by the means of mass ratios:

$$\frac{M_F}{M_P} = \frac{(w_P - w_T)}{(w_F - w_T)}$$

and

$$\frac{M_T}{M_P} = \frac{(w_P - w_F)}{(w_F - w_T)}$$

where  $M_P$ ,  $M_T$  and  $M_F$  are the masses and  $w_P$ ,  $w_T$  and  $w_F$   $^{235}\text{U}$  concentrations (by weight) of the feed, product and tails, respectively [37].

The separative work needed for uranium enrichment is then given as

$$W = M_P \cdot V_P + M_T \cdot V_T - M_F \cdot V_F$$

where  $V$  is a value function defined for each component P,T and F as

$$V = (1 - 2w) \ln \left[ \frac{1 - w}{w} \right]$$

An online calculator based on these formulae is able to calculate the separative work needed for enriching sufficient quantities of LEU for the modified IR-40 reactor [114].

### Mo-99 activity

The activity for the Iranian target is given by equation (25).

$$A = \frac{Y_{\text{Mo99}} \cdot \sigma_f \cdot \varepsilon \cdot \rho_U \cdot N_A \cdot \phi}{M_U \cdot k} \cdot \left( 1 - e^{-\frac{\ln 2}{2.75} t_{\text{irr}}} \right)$$

The density of the natural pressed  $\text{UO}_2$  target is  $4.67 \text{ g/cm}^3$ , while the uranium density is found by multiplying by the weight fraction of uranium in  $\text{UO}_2$  which is  $(238/270) = 0.882$ , yielding  $\rho_U = 4.12 \text{ g/cm}^3$ .

For a NU target the total EOB activity after 0 to 7 days is

Flux / days	0	1	2	3	4	5	6	7
4,00E+13	0	14	25	33	40	45	49	52
5,00E+13	0	17,47	31,06	41,61	49,81	56,19	61,14	65
6,00E+13	0	20,97	37,27	49,93	59,78	67,43	73,37	78
7,00E+13	0	24	43	58	70	79	86	91
8,00E+13	0	28	50	67	80	90	98	104
9,00E+13	0	31	56	75	90	101	110	117
1,00E+14	0	35	62	83	100	112	122	130

For a LEU target the total EOB activity after 0 to 7 days is

Flux / days	0	1	2	3	4	5	6	7
4,00E+13	0	383	681	913	1093	1233	1342	1426
5,00E+13	0	479	852	1141	1366	1541	1677	1783
6,00E+13	0	575	1022	1370	1640	1850	2013	2139
7,00E+13	0	671	1193	1598	1913	2158	2348	2496
8,00E+13	0	767	1363	1826	2186	2466	2684	2853
9,00E+13	0	863	1533	2055	2460	2774	3019	3209
1,00E+14	0	959	1704	2283	2733	3083	3354	3566

## Appendix C

The input for the CSAS6 module for the IR-40 reactor fuel with natural uranium is given as

'Input generated by Geewiz SCALE 6.1 Compiled on Mon Jun 6 11:04:33 2011

```
=csas6
ir-40 rbmk
238groupndf5
read composition
uo2      1 1 850      end
zirc2    3 1 700      end
helium   4 den=0.00089 1 500      end
d2o      5 0.9975 343      end
h2o      5 0.0025 343      end
aluminum 6 1 700      end
uo2      7 1 300      end
zirc2    11 1 343      end
helium   12 den=0.89 1 500      end
n        13 den=0.00125 1 500      end
ss304    14 1 343      end
end composition
read celldata
  latticecell triangpitch fuelr=0.574 1 gapr=0.5965 4 cladr=0.6815 3
  hpitch=0.885 5 end
end celldata
read parameter
gen=510
nsk=10
res=1
flx=yes
htm=yes
wrs=35
end parameter
read geometry
unit 1
com="brenselpinne"
cylinder 1 0.574 340 0
cylinder 2 0.5956 343 -3
cylinder 3 0.6815 345 -5
media 1 1 1
media 4 1 2 -1
media 3 1 3 -2
boundary 3
unit 2
com="brenselement"
hole 1 origin x=-2.995 y=0.803 z=0
hole 1 origin x=2.995 y=-0.803 z=0
hole 1 origin x=2.995 y=0.803 z=0
hole 1 origin x=-2.995 y=-0.803 z=0
hole 1 origin x=2.193 y=2.193 z=0
hole 1 origin x=-2.193 y=-2.193 z=0
hole 1 origin x=-2.193 y=2.193 z=0
hole 1 origin x=2.193 y=-2.193 z=0
hole 1 origin x=0.803 y=1.39 z=0
hole 1 origin x=-0.803 y=1.39 z=0
hole 1 origin x=-0.803 y=-1.39 z=0
hole 1 origin x=0.803 y=-1.39 z=0
hole 1 origin x=1.605 y=0 z=0
hole 1 origin x=-1.605 y=0 z=0
hole 1 origin x=0.803 y=2.995 z=0
hole 1 origin x=-0.803 y=2.995 z=0
hole 1 origin x=0.803 y=-2.995 z=0
```

*Composition* defines the material specifications for the model

*Parameter* defines parameter specifications for output file prints and other code calculation bounds

*Geometry* provides the KENO-VI model specification, as defined by units parameter specifications for output file prints and other code calculation bounds

```

hole 1  origin  x=-0.803 y=-2.995 z=0
cylinder 2      4      345      -5
cylinder 3      4.4    345      -5
hexprism 4     13.25   350     -10
cylinder 5      0.625  345     -5
cylinder 6      0.75   345     -5
hole 8  origin  x=0 y=0 z=-5
media 11 1 3 -2
media 5 1 4 -3
media 5 1 2 -6
media 13 1 5
media 3 1 6 -5
boundary 4
unit 3
com="water"
hexprism 1     13.25     350     -10
media 5 1 1
boundary 1
global unit 4
com="global unit 4 references array 1"
cylinder 1     230     500     -100
cylinder 2     220     350     -10
array 1 2 place 16 17 1 0 0 0
cylinder 3     235     505     -105
media 5 1 1 -2
media 14 1 3 -1
boundary 3
unit 8
com="endestykke"
cone 1      4.3      0      2      -3
cone 2      3.3      0      1      -2
ecylinder 3  0.5      1      3      0  origin  x=0 y=3 z=-3
ecylinder 4  0.5      1      3      0  origin  x=0 y=-3 z=-
3
ecylinder 5  1      0.5      3      0  origin  x=3 y=0 z=-3
ecylinder 6  1      0.5      3      0  origin  x=-3 y=0 z=-
3
ecylinder 7  1      0.5      3      0  origin  x=2.1 y=2.1
z=-3 rotate a1=45 a2=0 a3=0
ecylinder 8  1      0.5      3      0  origin  x=2.1 y=-2.1
z=-3 rotate a1=-45 a2=0 a3=0
ecylinder 9  1      0.5      3      0  origin  x=-2.1 y=-
2.1 z=-3 rotate a1=45 a2=0 a3=0
ecylinder 10 1      0.5      3      0  origin  x=-2.1
y=2.1 z=-3 rotate a1=-45 a2=0 a3=0
media 11 1 1 -2 -3 -4 -5 -6 -7 -8 -9 -10
media 5 1 2 -3 -4 -5 -6 -7 -8 -9 -10
media 5 1 3
media 5 1 4
media 5 1 5
media 5 1 6
media 5 1 7
media 5 1 8
media 5 1 9
media 5 1 10
boundary 1
unit 9
com="tube"
hexprism 1     13.25     350     -10
cylinder 2     4.4     345     -5
cylinder 3     4     345     -5
media 5 1 1 -2
media 3 1 2 -3
media 5 1 3

```





The input for the TRITON module for the IR-40 reactor fuel with natural uranium is given as

```
'Input generated by Geewiz SCALE 6.1 Compiled on Mon Jun 6 11:04:33
2011
'batch_args \-c
=t6-depl parm=(orgnflux)
ir-40 depletion natural uranium with real geometry
v7-238
read composition
uo2          1 den=10.4 1 900    end
zirc2        3 1 500    end
helium       4 den=0.00082 1 700  end
d2o          5 0.9975 343  end
h2o          5 0.0025 343  end
aluminum     6 1 343    end
h2o          8 1 350    end
uo2          9 den=10.5 1 700

                                92234 0.005407837
                                92235 19
                                92238 80.99459  end

n            10 den=0.00125 1 343  end
c-graphite   11 1 300    end
ss316s       12 1 343    end
ss304        13 1 343    end
aluminum     14 1 343    end
aluminum     15 1 343    end
zirc2        16 1 343    end
end composition
read celldata
  latticecell trianpitch fuelr=0.574 1 gapr=0.5965 4 cladr=0.6815 3
  hpitch=0.885 5 end
end celldata
read depletion
-1 flux 6 14 15
end depletion
read burndata
  power=4.6 burn=120 nlib=4 end
  power=4.6 burn=120 nlib=4 end
  power=4.6 burn=120 nlib=4 end
  power=4.6 burn=120 nlib=4 end
  power=4.6 burn=120 nlib=4 end
end burndata
read keep
  opus
end keep
read timetable
end timetable
read opus
  title="pu"
  symnuc=pu-238 pu-239 pu-240 pu-241 pu-242 u-234 u-235 u-236 u-238 end
  units=grams
  time=days
  title="pu"
  matl=1 end
end opus
read model
read parameter
npg=500
flx=yes
htm=yes
plt=no
cfx=yes
```

*Composition* defines the material specifications for the model

*Celldata* defines lattice specifications for cross section processing

*Depletion* specifies which materials to track changing isotopic

*Burndata* defines the cycle length, specific power and number of cross sections updates (*nlib*)

```

end parameter
read geometry
unit 1
com="fuel pin"
cylinder 1 0.574 340 0
cylinder 2 0.5956 343 -3
cylinder 3 0.6815 345 -5
media 1 1 1
media 4 1 2 -1
media 3 1 3 -2
boundary 3
unit 2
com="fuel assembly"
hole 1 origin x=-2.995 y=0.803 z=0
hole 1 origin x=2.995 y=-0.803 z=0
hole 1 origin x=2.995 y=0.803 z=0
hole 1 origin x=-2.995 y=-0.803 z=0
hole 1 origin x=2.193 y=2.193 z=0
hole 1 origin x=-2.193 y=-2.193 z=0
hole 1 origin x=-2.193 y=2.193 z=0
hole 1 origin x=2.193 y=-2.193 z=0
hole 1 origin x=0.803 y=1.39 z=0
hole 1 origin x=-0.803 y=1.39 z=0
hole 1 origin x=-0.803 y=-1.39 z=0
hole 1 origin x=0.803 y=-1.39 z=0
hole 1 origin x=1.605 y=0 z=0
hole 1 origin x=-1.605 y=0 z=0
hole 1 origin x=0.803 y=2.995 z=0
hole 1 origin x=-0.803 y=2.995 z=0
hole 1 origin x=0.803 y=-2.995 z=0
hole 1 origin x=-0.803 y=-2.995 z=0
cylinder 2 4 345 -5
cylinder 3 4.4 345 -5
hexprism 5 13.25 350 -10
cylinder 6 0.625 345 -5
cylinder 7 0.75 345 -5
hole 7 origin x=0 y=0 z=-5
media 16 1 3 -2
media 5 1 2 -7
media 5 1 -3 5
media 10 1 6
media 16 1 7 -6
boundary 5
unit 3
com="d2o hexagons"
hexprism 1 13.25 350 -10
media 5 1 1
boundary 1
global unit 4
com="core"
cylinder 1 220 450 -50
cylinder 2 195 350 -10
array 1 2 place 10 10 1 0 0 0
cylinder 4 225 455 -55
media 5 1 1 -2
media 13 1 4 -1
boundary 4
unit 7
com="end plug"
cone 1 4.3 0 2 -3
cone 2 3.3 0 1 -2
ecylinder 3 0.5 1 3 0 origin x=0 y=3 z=-3
ecylinder 4 0.5 1 3 0 origin x=0 y=-3 z=-
3

```

Geometry provides the KENO-VI model specification, as defined by units.

The *global unit* specifies the outer boundary of the model.

```

    eycylinder 5      1      0.5      3      0  origin  x=3 y=0 z=-3
    eycylinder 6      1      0.5      3      0  origin  x=-3 y=0 z=-
3
    eycylinder 7      1      0.5      3      0  origin  x=2.1 y=2.1
z=-3 rotate  a1=45 a2=0 a3=0
    eycylinder 8      1      0.5      3      0  origin  x=2.1 y=-2.1
z=-3 rotate  a1=-45 a2=0 a3=0
    eycylinder 9      1      0.5      3      0  origin  x=-2.1 y=-
2.1 z=-3 rotate  a1=45 a2=0 a3=0
    eycylinder 10     1      0.5      3      0  origin  x=-2.1
y=2.1 z=-3 rotate  a1=-45 a2=0 a3=0
media 3 1 1 -2 -3 -4 -5 -6 -7 -8 -9 -10
media 5 1 2 -3 -4 -5 -6 -7 -8 -9 -10
media 5 1 3
media 5 1 4
media 5 1 5
media 5 1 6
media 5 1 7
media 5 1 8
media 5 1 9
media 5 1 10
boundary 1
unit 9
com="experimental tubes"
cylinder 1      4.4      350      -10
cylinder 2      4      350      -10
hexprism 3      13.25      350      -10
media 16 1 1 -2
media 5 1 2
media 5 1 3 -1
boundary 3
unit 10
com="alurod1"
cylinder 4      3      30      0
media 6 1 4
boundary 4
unit 11
com="targethex"
hexprism 1      13.25      350      -10
hole 10  origin  x=0 y=0 z=165
hole 12  origin  x=0 y=0 z=235
hole 13  origin  x=0 y=0 z=200
media 5 1 1
boundary 1
unit 12
com="alurod 2"
cuboid 1      0.5      -0.5      4      -4      25      0
cylinder 2      3      30      0
media 14 1 2
boundary 2
unit 13
com="alurod 3"
cuboid 2      0.5      -0.5      4      -4      25      0
cylinder 3      3      30      0
media 15 1 3
boundary 3
unit 14
com="aluhex2"
hexprism 1      13.25      350      -10
hole 12  origin  x=0 y=0 z=200
media 5 1 1
boundary 1
unit 15
com="aluhex3"

```

```

hexprism 1      13.25      350      -10
hole 13  origin x=0 y=0 z=200
media 5 1 1
boundary 1
end geometry
read array
ara=1 nux=20 nuy=20 nuz=1 typ=shexagonal gbl=1
com=''
fill
  3 3 3 3 3 3 3 3 3 3 3 3 3 3 3 3 3 3 3 3
  3 3 3 3 3 3 3 9 9 9 9 9 3 3 3 3 3 3 3 3
  3 3 3 3 3 3 3 9 9 2 2 2 2 9 9 3 3 3 3 3
  3 3 3 3 9 9 2 2 2 2 2 2 2 9 9 3 3 3 3 3
  3 3 3 3 9 2 2 2 2 2 2 2 2 2 2 9 3 3 3 3
  3 3 3 9 2 2 2 2 2 2 2 2 2 2 2 2 9 3 3 3
  3 3 9 2 2 2 2 2 2 2 2 2 2 2 2 2 9 3 3 3
  3 3 3 9 2 2 2 2 2 2 2 2 2 2 2 2 9 3 3 3
  3 3 9 2 2 2 2 2 2 2 2 2 2 2 2 2 9 3 3 3
  3 3 3 9 2 2 2 2 2 2 2 2 2 2 2 2 9 3 3 3
  3 3 9 2 2 2 2 2 2 2 2 2 2 2 2 2 9 3 3 3
  3 3 3 9 2 2 2 2 2 2 2 2 2 2 2 2 9 3 3 3
  3 3 3 3 9 2 2 2 2 2 2 2 2 2 2 2 9 3 3 3
  3 3 3 3 9 9 2 2 2 2 2 2 2 9 9 3 3 3 3 3
  3 3 3 3 3 3 9 9 2 2 2 2 9 9 3 3 3 3 3
  3 3 3 3 3 3 3 9 9 9 9 9 3 3 3 3 3 3 3
  3 3 3 3 3 3 3 3 3 3 3 3 3 3 3 3 3 3 3
  3 3 3 3 3 3 3 3 3 3 3 3 3 3 3 3 3 3 3 end fill
end array
end data
end model
end

```

The different TRITON inputs for different levels of enrichment are equal in everything but the level of enrichment, and the weight percentage of boron carbide. The configurations with lower level of enrichment have less boron carbide.

The input for the TRITON module for the modified IR-40 reactor fuel with 15 % LEU is given as

```
'Input generated by Geewiz SCALE 6.1 Compiled on Mon Jun  6 11:04:33
2011
'batch_args \-c
=t6-depl parm=(orgnflux)
ir-40 depletion natural uranium with real geometry
v5-44
read composition
  uo2          1 den=10.4 1 850
                                92234 0.005407837
                                92235 15
                                92238 84.99459   end
  d2o          2 1 300   end
  zirc2        3 1 500   end
  helium       4 den=0.00082 1 500   end
  d2o          5 0.9975 343   end
  h2o          5 0.0025 343   end
  al2o3        6 0.9 343   end
  b4c          6 0.1 343   end
  zirc2        7 1 500   end
  d2o          8 0.9975 343   end
  h2o          8 0.0025 343   end
  aluminum     9 1 343   end
  n           10 den=0.00125 1 500   end
  ss316s      12 1 343   end
end composition
read celldata
  latticecell triangpitch fuelr=0.574 1 gapr=0.5965 4 cladr=0.6815 3
  hpitch=0.885 5 end
end celldata
read depletion
  -1 flux 6
end depletion
read burndata
  power=21 burn=360 nlib=3 end
  power=21 burn=360 nlib=3 end
  power=21 burn=360 nlib=3 end
  power=21 burn=120 end
end burndata
read keep
  opus
end keep
read timetable
end timetable
read opus
  title="pu"
  symnuc=pu-238 pu-239 pu-240 pu-241 pu-242 pu-243 u-234 u-235 u-236
u-238 end
  units=grams
  time=days
  title="pu"
  matl=1 end
end opus
read model
read parameter
  gen=210
```

```

npg=500
nsk=10
flx=yes
htm=yes
plt=no
cfx=yes
end parameter
read geometry
unit 1
com="fuel pin"
cylinder 1 0.574 240 0 origin x=0 y=0 z=50
cylinder 2 0.5956 343 -3
cylinder 3 0.6815 345 -5
media 1 1 1
media 4 1 2 -1
media 3 1 3 -2
boundary 3
unit 2
com="fuel assembly"
hole 1 origin x=-2.995 y=0.803 z=0
hole 1 origin x=2.995 y=-0.803 z=0
hole 1 origin x=2.995 y=0.803 z=0
hole 1 origin x=-2.995 y=-0.803 z=0
hole 27 origin x=2.193 y=2.193 z=0
hole 27 origin x=-2.193 y=-2.193 z=0
hole 27 origin x=-2.193 y=2.193 z=0
hole 27 origin x=2.193 y=-2.193 z=0
hole 1 origin x=0.803 y=1.39 z=0
hole 1 origin x=-0.803 y=1.39 z=0
hole 1 origin x=-0.803 y=-1.39 z=0
hole 1 origin x=0.803 y=-1.39 z=0
hole 1 origin x=1.605 y=0 z=0
hole 1 origin x=-1.605 y=0 z=0
hole 1 origin x=0.803 y=2.995 z=0
hole 1 origin x=-0.803 y=2.995 z=0
hole 1 origin x=0.803 y=-2.995 z=0
hole 1 origin x=-0.803 y=-2.995 z=0
cylinder 2 4 345 -5
cylinder 3 4.4 345 -5
hexprism 5 13.25 350 -10
cylinder 6 0.625 345 -5
cylinder 7 0.75 345 -5
hole 7 origin x=0 y=0 z=-5
media 7 1 3 -2
media 5 1 2 -7
media 8 1 -3 5
media 10 1 6
media 7 1 7 -6
boundary 5
unit 3
com="water"
hexprism 1 13.25 350 -10
media 8 1 1
boundary 1
global unit 4
com="core"
cylinder 1 220 450 -50
cylinder 2 195 350 -10
array 1 2 place 11 11 1 0 0 0
cylinder 4 225 455 -55
media 5 1 1 -2
media 12 1 4 -1
boundary 4
unit 7

```

```

com="endestykke"
cone 1      4.3      0      2      -3
cone 2      3.3      0      1      -2
ecylinder 3      0.5      1      3      0 origin x=0 y=3 z=-3
ecylinder 4      0.5      1      3      0 origin x=0 y=-3 z=-
3
ecylinder 5      1      0.5      3      0 origin x=3 y=0 z=-3
ecylinder 6      1      0.5      3      0 origin x=-3 y=0 z=-
3
ecylinder 7      1      0.5      3      0 origin x=2.1 y=2.1
z=-3 rotate a1=45 a2=0 a3=0
ecylinder 8      1      0.5      3      0 origin x=2.1 y=-2.1
z=-3 rotate a1=-45 a2=0 a3=0
ecylinder 9      1      0.5      3      0 origin x=-2.1 y=-
2.1 z=-3 rotate a1=45 a2=0 a3=0
ecylinder 10     1      0.5      3      0 origin x=-2.1
y=2.1 z=-3 rotate a1=-45 a2=0 a3=0
media 3 1 1 -2 -3 -4 -5 -6 -7 -8 -9 -10
media 5 1 2 -3 -4 -5 -6 -7 -8 -9 -10
media 5 1 3
media 5 1 4
media 5 1 5
media 5 1 6
media 5 1 7
media 5 1 8
media 5 1 9
media 5 1 10
boundary 1
unit 9
com="experimental tubes"
cylinder 1      4.3      350      -10
cylinder 2      4      350      -10
hexprism 3      13.25      350      -10
media 3 1 1 -2
media 5 1 2
media 5 1 3 -1
boundary 3
unit 25
com="target"
cylinder 1      3      15      0 origin x=0 y=0 z=150
media 6 1 1
boundary 1
unit 26
com="mollytargets"
hole 25
hexprism 1      13.25      350      -10
media 5 1 1
boundary 1
unit 27
com="boronrod"
cylinder 2      0.5956      240      0 origin x=0 y=0 z=50
cylinder 3      0.7      345      -5
media 6 1 2
media 7 1 3 -2
boundary 3
end geometry
read array
ara=1 nux=20 nuy=20 nuz=1 typ=shexagonal gbl=1
com=''
fill
3 3 3 3 3 3 3 3 3 3 3 3 3 3 3 3 3 3 3 3
3 3 3 3 3 3 3 3 3 3 3 3 3 3 3 3 3 3 3 3
3 3 3 3 3 9 9 9 9 9 9 9 9 9 9 9 9 3 3 3 3

```



```

3 3 3 3 9 9 9 9 9 9 9 9 9 9 9 9 3 3 3 3
3 3 3 3 9 9 9 9 9 9 9 9 9 9 9 9 3 3 3 3
3 3 3 9 9 9 9 9 9 2 2 9 9 9 9 9 9 3 3 3 3
3 3 3 9 9 9 9 9 2 2 9 2 2 9 9 9 9 9 3 3 3
3 3 9 9 9 9 2 2 2 2 2 2 2 2 9 9 9 9 3 3 3
3 3 3 9 9 9 2 9 2 9 2 9 2 9 2 9 9 9 3 3 3
3 3 9 9 9 9 2 2 2 2 2 2 2 2 9 9 9 9 3 3 3
3 3 3 9 9 9 2 2 9 2 26 2 9 2 2 9 9 9 3 3 3
3 3 9 9 9 9 2 2 2 2 2 2 2 2 9 9 9 9 3 3 3
3 3 3 9 9 9 2 9 2 9 2 9 2 9 2 9 9 9 3 3 3
3 3 3 9 9 9 2 2 2 2 2 2 2 2 9 9 9 9 3 3 3
3 3 3 9 9 9 9 9 2 2 9 2 2 9 9 9 9 9 3 3 3
3 3 3 9 9 9 9 9 9 2 2 9 9 9 9 9 9 3 3 3 3
3 3 3 3 9 9 9 9 9 9 9 9 9 9 9 9 3 3 3 3
3 3 3 3 3 3 9 9 9 9 9 9 9 9 9 9 3 3 3 3 3
3 3 3 3 3 3 3 3 3 3 3 3 3 3 3 3 3 3 3 3 end fill
end array
end data
end model
end

```